



# CATALOGUE 2022



Porta HIDE

**TOP**  
COLLECTIONS

**30** YEARS  
OF OPENNESS

# I CARE ABOUT THE WORLD I AM ECO -FRIENDLY

**ON OUR WEBSITE**

**PORTA.COM.PL/DO-POBRANIA  
YOU CAN FIND ALL OF OUR  
CATALOGUES, ALWAYS  
UP TO DATE**

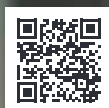

**OPEN UP TO ECOLOGY WITH US, CHOOSE  
MOBILE VERSION OF THE CATALOGUE**



**WE CARE ABOUT THE ENVIRONMENT  
WE PRODUCE RESPONSIBLY**

# Table of contents

## 01 INTERIOR DOORS 4 ELEMENTS

4 ELEMENTS - AIR - <b>NEW</b> .....	18
4 ELEMENTS - WATER - <b>NEW</b> .....	20
4 ELEMENTS - FIRE - <b>NEW</b> .....	22
4 ELEMENTS - EARTH - <b>NEW</b> .....	24

## 02 PAINTED INTERIOR DOORS

MINIMAX .....	28
LONDON, VIENNA .....	30
Porta ROYAL Premium, Porta SKANDIA Premium .....	32
Porta VECTOR Premium .....	34
PORTA ART DECO - <b>NEW</b> .....	36
Porta FOCUS Premium .....	38
Porta DESIRE UV .....	40
Porta GRANDE UV .....	42
Porta DUO .....	44
Porta HIDE .....	46

## 03 FRAME AND PANEL INTERIOR DOORS

### SYNTHETIC VENEER

PORTA VERTE HOME BLACK - <b>NEW</b> .....	48
Porta Verte HOME B .....	50
Porta Verte HOME C .....	52
Porta Verte HOME D .....	54
Porta Verte HOME E .....	56
Porta Verte HOME G .....	58
Porta Verte HOME H .....	60
Porta Verte HOME J .....	62
Porta Verte HOME L, N .....	64
Porta Verte PREMIUM A, D .....	66
Porta Verte PREMIUM B, C .....	68
Porta Verte PREMIUM E .....	70
Porta CONCEPT, group A and B .....	72
Porta CONCEPT, group C .....	74
Porta CONCEPT, group H and K .....	76
Porta BALANCE .....	78
Porta HARMONY .....	80
Porta INSPIRE, group A and B .....	82
Porta INSPIRE, group C .....	84

## 04 FLUSH INTERIOR DOORS

### SYNTHETIC VENEER

PORTA GLASS - <b>NEW</b> .....	86
Porta DECOR .....	88
Porta STYL .....	90
Porta FIT, group C, I .....	92
Porta FIT, group F-H .....	94
Porta NOVA group 2-5 .....	96
Porta NOVA group 6 and 7 .....	98
Porta LEVEL .....	100
Porta LINE .....	102
Porta CPL .....	104
Investment set .....	106
Porta RESIST .....	108
Porta FOCUS .....	110
Porta LOFT .....	112

## 05 INTERIOR DOORS. NATURAL VENEER

Nature CLASSIC .....	114
Nature LINE .....	116
Nature VECTOR .....	118
Nature LOFT .....	120
Nature GRANDE .....	122
Nature SPACE .....	124
Nature CONCEPT .....	126
SEVILLA .....	128
MADRID, CORDOBA, TOLEDO .....	128
Villadora RETRO .....	132

## 06 FOLDING AND SLIDING DOORS

Folding doors ALFA, BETA .....	134
Sliding system PORTA, ALU .....	136
Sliding system COMPACT .....	138
Sliding system BLACK, SLIDE .....	140
Sliding system EFEKT .....	142
FRAMELESS sliding system - <b>NEW</b> .....	122

## 07 TECHNICAL DOORS

Entrance and technical doors - summary of the models	148
Acoustic 27 dB, 32 dB .....	150
INNOVO 37 dB .....	152
SILENCE 37dB, EI30 .....	154
INNOVO 42 dB .....	156
Acoustic 42 dB .....	158
PURE 57 dB .....	160
Fire-rated EI 30, EI 60 .....	162
ENDURO .....	164
PORTA STRENGTH PERFORMANCE CLASS 4 - <b>NEW</b> .....	166
AQUA .....	168

## 08 APARTMENT ENTRANCE DOORS

AGATE, OPAL - class RC 2 .....	172
EXTREME - class RC 2 .....	174
Steel SECURE - class RC 3 - <b>NEW</b> .....	176
QUARTZ - class RC 2 .....	178
EXTREME - Anti-burglary class RC 3 .....	180
EXTREME - Anti-burglary class RC 4 - <b>NEW</b> .....	182
GRANITE - Anti-burglary class C .....	184

## 09 EXTERIOR ENTRANCE DOORS

Steel SAFE and ENERGY PROTECT .....	186
-------------------------------------	-----

## 10 STEEL TECHNICAL DOORS

Doors for utility rooms, storage rooms .....	188
Steel BASIC, Steel exterior BASIC PLUS .....	190
Steel SOLID .....	192
Steel EI 30, EI 60 .....	194
Steel EI 30 PLUS, EI 60 PLUS - <b>NEW</b> .....	32

## 11 DOOR FRAMES

MINIMAX .....	198
Porta SYSTEM, Porta SYSTEM GK .....	200
Porta SYSTEM ELEGANCE .....	202
Porta SYSTEM ELEGANCE 90 degrees .....	202
Porta SYSTEM with a reversed rebate .....	204
LEVEL .....	206
Porta RENOVA .....	208
Villadora RETRO .....	210

## 12 STEEL DOOR FRAMES

Steel Porta SYSTEM ELEGANCE .....	212
Steel Porta SYSTEM .....	212
Non-rebated, Adjustable steel frame .....	214
Adjustable, Adjustable PS with 'sharp edges' .....	214
Corner profile, non-rebated - LARGE .....	216
Corner profile frame SMALL PLUS, LARGE .....	216
PROJECT BIS, PROJECT Premium .....	218

## 13 ACCESSORIES, DIMENSIONS, ADDITIONAL INFORMATION

Handles - <b>NEW</b> .....	222
Hinges, locks, other accessories .....	233
Skirting-boards and ventilation .....	237
Technical drawings, Door dimensions .....	239
Durability levels of Porta finishes, finishes charts .....	249
Glass panels .....	258

# Characteristics of our products

## MEANING OF THE SYMBOLS THAT DESCRIBES OUR PRODUCTS' FEATURES

**TOP**  
COLLECTIONS  
The most popular PORTA  
collections

### DESIGN, GLAZING, MIRROR

You can choose a glass panel with different designs and level of transparency.



Design your door



Optional mirror



Natural veneer



Premium paint



UV paint

### CONSTRUCTION

While choosing the type of construction you determine, inter alia, endurance, stability, sound proofness, and thermal insulation of your door.



Frame and panel construction



**Burglar resistance**  
RC 2 class, RC 3 class, C class.  
Resistance to unpermitted opening



**Fire resistance**  
EI 30, EI 60  
Ability to stop the fire  
for 30 or 60 minutes



**Smoke control**  
class Sa, S<sub>200</sub>  
It defines door's tightness  
to smoke leakage



**Acoustic insulation**  
Rw 27 dB D, 25, Rw 32 dB D, 30,  
Rw 37 dB D, 35, Rw 42 dB D, 40  
It defines acoustic rating of a door



**Strength performance class**  
class 1, class 2, class 3, class 4  
The performance levels in resisting various loads,  
impacts and torsions indicating normal usage  
for a range of categories of duty



**Porta CONTRACT**  
Bespoke design, made to measure



**AQUA STOP**  
lower edge protection against  
humidity in TechnoPorta technology



### DOOR FRAME

A door frame is as important part of a doorset as a door leaf. There are a lot of door frame types and choosing one, please consider that they may come in three options: rebated, non-rebated or with reversed rebate.



non-rebated



rebated



Reversed rebate



Project BIS,  
Project Premium



Door frame adjustment  
available



Architraves available in  
two sizes: 60 mm and  
80 mm



Retro module

### DOOR LEAF

Door design may have different functional solutions depending on interior needs and functions.



Available sizes for  
a single door:  
min. '60', max. '110'



Available sizes for  
a double door:  
min. '90', max. '220'



Standard height  
door leaf 2030



Increased height  
door leaf 2200



Door leaf thickness  
depends on chosen  
construction



Sliding door leaf



Reversible door  
right-left

# Please note ...

■ OUR DOORS ARE ANTI-BULGLARY

(RC 2) class - resistance class to provide basic protection against break-in attempts with use of simple tools e.g. a screwdriver, a wedge, pincers, a hammer.



(RC 3) class - resistance class to provide protection against break-in attempts with use of tools e.g. a crowbar, a cotter pin driver, a mechanical drill.



RC-resistance class it's the ability of certain product to withstand violent intrusion in protected rooms or areas.

■ Before purchasing a door you need to decide on the opening direction



SINGLE DOOR  
LEFT DOOR LEAF



SINGLE DOOR  
RIGHT DOOR LEAF



DOUBLE LEAF DOOR

■ CALCULATE THE DOOR PRICE

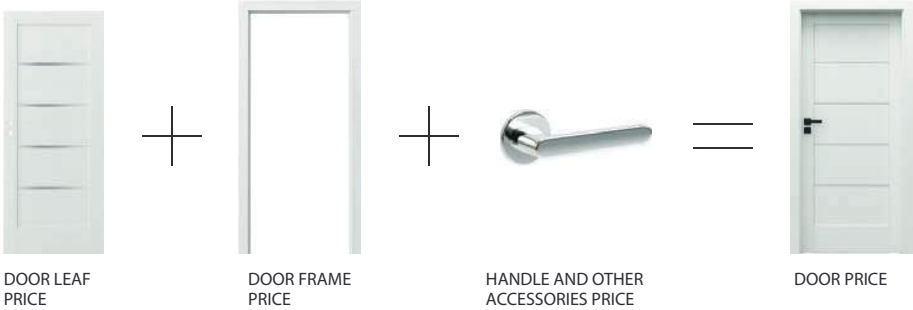

■ PRODUCTION TIME\*

Check on [www.portadoors.com](http://www.portadoors.com)

\*production time may differ as it depends on the quantity and type of ordered products.

# MANY ADVANTAGES OF A STEEL DOOR FRAME

## VERSATILITY

Thanks to their durability and attractive look, steel door frames are the perfect choice for the most demanding areas. Their versatility make them a good choice for both new and older buildings that require thoughtful renovation and give them a unique style and design. Possibility of customisation and a lot of contract options, including any RAL or NCS colour, opens up many options.



## INVISIBLE JOINTS

Steel door frames have welded and ground joints. Next they are painted with our Premium polyester paint. Thanks to this process, joint lines are invisible and very durable at the same time.



## HIGH DURABILITY

High-precision manufacturing and first-rate materials guarantee long-term quality. Their high resistance to mechanical damages and corrosion make them great, long-lasting products. Steel door frame is a good choice, especially for rooms with increased humidity, e.g. kitchens or bathrooms.



## HUMIDITY RESISTANCE

Our steel door frames are made out of galvanized steel sheet and additionally secured with passivation layer. Then, a layer of polyester powder paint is applied on the surface. This all together results in increasing corrosion resistance for many years and in protecting frames against water, e.g. during floor cleaning.



Door leaf - Porta Decor, model P  
with steel door frame Porta SYSTEM ELEGANCE

PLEASE  
NOTE



PORTA ART DECO see page. 36



Black glass panel in chosen models



Grey, Portadecor available in various collections



Porta VERTE HOME BLACK see page 142

NEW SOLUTION

New door leaf height  
220 cm is available in  
chosen collections:  
4 ELEMENTS  
Porta VECTOR  
PORTA ART DECO  
Porta DESIRE  
Nature CLASSIC  
Nature LINE  
Nature VECTOR

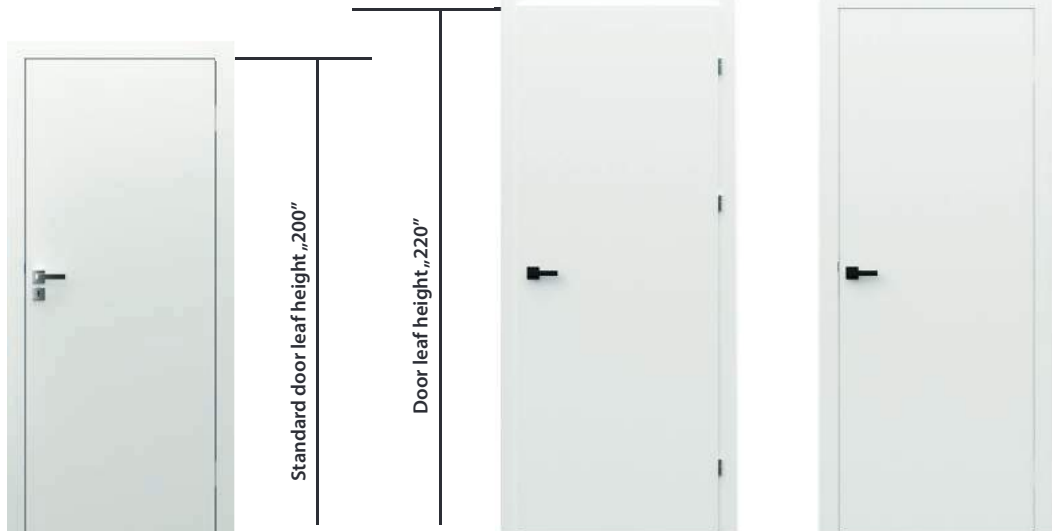

Porta SYSTEM

Porta SYSTEM ELEGANCE





**PORTA GLASS** see page. 36



**Frameless sliding system** see page 122



**Steel SECURE** see page. 150



**Matt oak** available in many collections



**Strength performance Class 4** see page. 166



**STEEL EI 30 PLUS, STEEL EI 60 PLUS** see page. 32

## COLOURS AVAILABLE IN MANY COLLECTIONS



## Gold Craft Oak

### Portaperfect and CPL Veneer

A very popular colour used by many manufacturers and in interior finishing elements.  
A warm and natural colour of the interior perfectly matching various styles.



**Match the  
colour with  
the floor or  
wall panels**



**Create  
a coherent  
space**

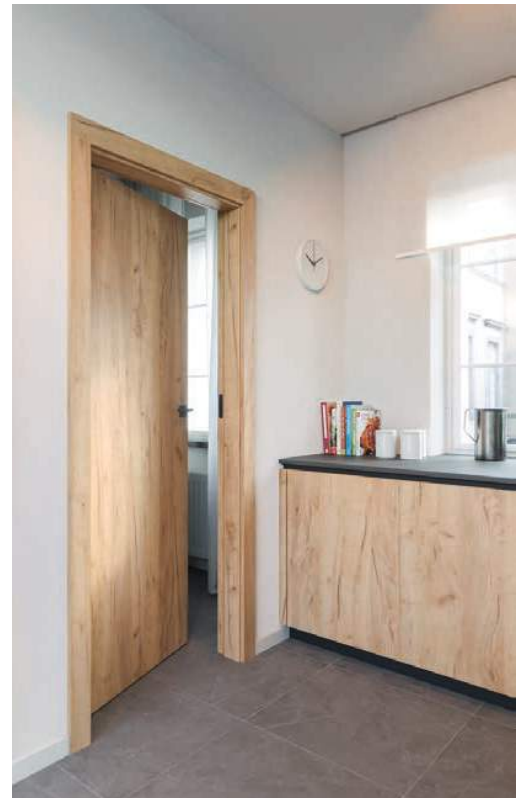



# Andersen Pine

## Portasynchro Veneer

The perfect colour found on furniture made by popular manufacturers.  
A light and neutral colour with a distinctive patterns is an alternative to white doors.



**Match the  
colour to the  
furniture**



**Create  
a coherent  
space**



# PORTA'S PANTONE colour

CHOOSE YOUR FAVOURITE COLOUR

## Varnished doors, you choose the colours

Our favourite colour this year is **Veri Peri** – selected by the PANTONE Color Institute as the Color of the Year 2022

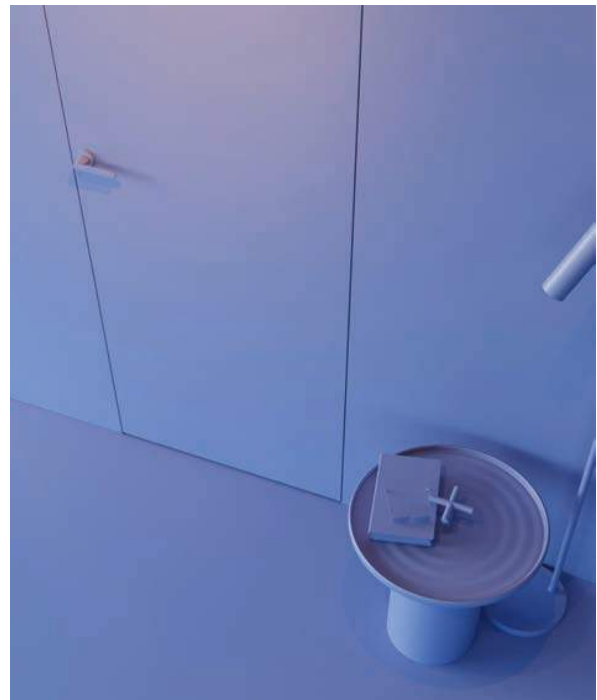

Design your interior by following the current trends

# PORTA STYLING

BE YOUR OWN DOOR STYLIST

## One product, different solutions

One product, different solutions. Thanks to the pad, you can easily and quickly change the nature of your doors. Take advantage of our accessories!

### LOFT styling ▶

- PORTA CPL
- steel door frame
- oval door handle plate
- ORGANIC handle



oval door handle plate



### ◀ CLASSIC styling

- PORTA HIDE
- wall slats
- skirting boards
- ORTICA knob

NEW

# AZURA collection

---

## Discover the new AZURA collection

The AZURA collection, a novelty in PORTA's offer, consists of door and furniture accessories. It allows the customers to create a unique ambience and maintain a consistent character of their interior design. The set includes door handles, escutcheons, door stops and a wide selection of furniture handles and wall hangers. The finish of the accessories set includes characteristic knurling and available in three colours: gloss gold, gloss silver, and matte black.





**AZURA set in silver**



**AZURA set in black**

**AZURA set in gold**



# INTERIOR DOORS

## 4 Elements

*porta design*

Nature is an endless source of inspiration.  
EARTH soothes. AIR relaxes. FIRE fascinates.  
WATER refreshes.

These four elements have inspired the creation of a collection of doors leading to exceptional interiors. The collection is a blend of fascination with beauty, combined with quality and functionality, designed with all the necessary elements to fully reflect the harmony that distinguishes the richness of nature.







# 4 Elements A/AIR

01



The traditional design and soft colours are a reference to the enduring vintage trend. It is a design that has been known for years, which will give your home a visual lightness and introduce a cozy atmosphere.

*porta* ♥ *design*

AIR P.3 collection, height "220", ORTICA knob in black



AIR P.3 collection, ORTICA knob in gold



model P.1



model P.2



model P.3



## AVAILABLE FINISHES

### Portadecor Veneer ★★★★★☆

Fiord

### Backing veneer /for self-painting

White

### WE RECOMMEND!

SKIRTING BOARDS AND WALL SLATS, see p. 237



door frame

## TECHNICAL INFORMATION

### DOOR LEAF DESIGN

Chipboard core reinforced with an inner stile. The entire structure is covered with high density fibreboard. The leaf is available in two finishing options: in backing veneer for painting or veneer in Fjord colour.

### ACCESSORIES IN DOOR LEAF PRICE

- non-rebated 3D hinges in the following colours: silver, black or gold (option at extra charge)
- magnetic lock in the following colours: stainless steel or black (option at extra charge)

### DOOR FRAMES

#### Recommended rebated door frames:

- PORTA SYSTEM in backing veneer p. 200

#### Recommended non-rebated door frames:

- PORTA SYSTEM ELEGANCE in backing veneer or Fjord veneer p. 202

### NOTES

- Standard PN-EN 14351-2:2018-12
- Preparation for shortening, max. 60 mm
- With height "220" three hinges as standard
- Fjord colour similar to NCS: S 3010-B50G
- The Fjord colour is available only in the PORTA SYSTEM ELEGANCE door frame

### EXTRA CHARGES

- ventilation undercut
- size „100“
- 3D hinges in gold
- third 3D hinge in silver / black
- third 3D hinge in gold
- leaf height 220 cm
- door frame: Fjord colour
- change of magnetic silver lock to black
- handle with escutcheon

(p. 224)

# 4 Elements **W/** WATER

01



WATER W.2 collection, height "220", MAXIMA CONNECT black handle with white insert

Linear design embodies the principle of reduction, which allows for full individuality in the interior. The simple design finished with a white UV acrylic paint will optically enlarge and illuminate the space.

#### NOTE

UV acrylic paint with very high resistance to:

- stains (coffee, alcohol, grease),
- abrasion,
- scratches,
- impacts.

**Guarantee of colour permanence for years.**

**For the door leaf we recommend door frame in UV acrylic paint.**

*porta design*

**UV**  
HIGH  
RESISTANCE



WATER W.1 collection, height "220", MAXIMA CONNECT black handle with white insert



model W.1



model W.2



## AVAILABLE FINISHES

### UV acrylic paint ★★★★★☆

White



milling model W.1



milling model W.2



MAXIMA CONNECT handle



close-up of milling

## TECHNICAL INFORMATION

### DOOR LEAF DESIGN

Chipboard filling reinforced with an inner stile. The entire structure is covered with high density fibreboard.

### ACCESSORIES IN DOOR LEAF PRICE

- non-rebated 3D hinges in the following colours: silver, black, white
- magnetic lock in the following colours: stainless steel or black, white (option at extra charge)

### DOOR FRAMES

- Recommended non-rebated door frames:**
- PORTA SYSTEM ELEGANCE 90 degrees p. 202

### NOTES

- Standard PN-EN 14351-2:2018-12
- preparation for shortening, max. 60 mm
- with height "220" three hinges as standard

### EXTRA CHARGES

- ventilation undercut
- size "100"
- third 3D hinge
- leaf height 220 cm
- change of magnetic silver lock to black
- handle with escutcheon

(p. 224)

# 4 Elements F/ FIRE

01



Free from rigid patterns, the door design combines modernity with a post-factory atmosphere. The compilation of "burnt wood" with the coolness of steel will be an interior stimulation of the senses.

*porta ♥ design*

FIRE O.1 Collection, Sherman Oak, PORTA SYSTEM ELEGANCE steel door frame, Fire handle



model O.1



model O.7

FIRE O.1 Collection, Sherman Oak, PORTA SYSTEM ELEGANCE steel door frame, MAXIMA black handle



## AVAILABLE FINISHES

## Gladstone ★★★★★★

Sherman  
Oak

## AVAILABLE FINISHES OF THE DOOR FRAME

## Polyester Premium Paint ★★★★★☆

Black  
texture

handle

## TECHNICAL INFORMATION

## DOOR LEAF DESIGN

Chipboard filling reinforced with an inner stile. The entire structure is covered with high density fibreboard. The leaf sides are covered with ABS tape in black colour.

## ACCESSORIES IN DOOR LEAF PRICE

- 3D door hinges in black
- lock for steel door frame in black
- magnetic system in black for version with handle (option at extra charge)
- additional lock in magnetic system for WC option in black (option at extra charge)

## DOOR FRAMES

## Recommended non-rebated door frames:

- Steel PORTA SYSTEM ELEGANCE p. 202

## NOTES

- Standard PN-EN 14351-2:2018-12
- preparation for shortening, max. 60 mm
- with height "220" three hinges as standard
- height "220" available in model O.1 only
- horizontal grain direction in model O.7
- black steel panels in model O.7 only

## EXTRA CHARGES

- ventilation undercut
- size "100"
- leaf height 220 cm
- magnetic system with handle:
- extra charge for leaf
- extra charge for door frame
- FIRE handle
- WC escutcheon with an additional lock
- handle with escutcheon

(p. 224)

# 4 Elements E/ EARTH

01



The organic naturalness of the earth tones combined with the geometric arrangement of the veneer create a unique play of textures. This juxtaposition is a gradation of harmony that will suit any style.

*porta ♥ design*

Earth Z.1 collection, height "220", Matt Oak, PORTA SYSTEM ELEGANCE 90° door frame in black, AZALIA handle in black



model Z.1



model Z.1

EARTH Z.1 collection, height "220", Matt Oak, door frame PORTA SYSTEM ELEGANCE 90°, AZALIA handle in silver





## AVAILABLE FINISHES

### Natural Oak Mat ★★★★★☆



## AVAILABLE FINISHES OF THE DOOR FRAME

### Natural Select Veneer ★★★★★☆



### Natural Oak Mat ★★★★★☆



geometric arrangement of natural veneer, matt varnish, Azalia handle

## TECHNICAL INFORMATION

### DOOR LEAF DESIGN

The filling of the door leaf is a stabilizing insert reinforced with an internal stile. The whole is covered with a board covered with high quality natural veneer. The leaf surface is protected with ecological water varnishes, hardened with UV technology. Hollow core chipboard filling.

### ACCESSORIES IN DOOR LEAF PRICE

- non-rebated 3D hinges in the following colours: silver, black
- magnetic lock in the following colours: stainless steel or black (option at extra charge)

### DOOR FRAMES

- Recommended non-rebated door frames:**
- PORTA SYSTEM ELEGANCE 90 degrees p. 202

### NOTES

- Standard PN-EN 14351-2:2018-12
- Preparation for shortening, max. 60 mm
- With height "220" three hinges as standard

### EXTRA CHARGES

- ventilation undercut
- size „100“
- third 3D hinge
- leaf height 220 cm
- change of magnetic silver lock to black
- handle with escutcheon

(p. 224)

# INTERIOR DOORS

We would like to invite you to be inspired by our diverse range of doors to suit your interior design requirements.

We supply various styles from wooden doors, to give that warm and cosy feel ,or the more sleek, modern and designer styles which are more on trend.

As we offer a wide and versatile range of products we feel confident that you will be able to find your perfect choice.





Porta LEVEL  
see page 100

# MINIMAX

02



MINIMAX P, White



MINIMAX P, White



model P



model M



model D



model L



## AVAILABLE FINISHES

Standard paint ★★☆☆☆☆



glazing bead with a glass panel



'Chinchilla' glass

## TECHNICAL INFORMATION

### DOOR LEAF CONSTRUCTION

Honeycomb or hollow chipboard core reinforced with rails and stiles. The construction is skinned with HDF.

### ACCESSORIES INCLUDED IN THE DOOR LEAF PRICE

- Two or three standard barrel hinges or PRIME hinges (optionally, at extra charge)
- Lock: key lock, WC lock, or cylinder lock
- 'Chinchilla' glass or frosted tempered glass (optionally, extra charge)
- Round pull handle (for sliding doors)

### DOOR FRAMES

#### Recommended rebated door frames:

- Porta SYSTEM in Portadecor veneer see p. 200
- MINIMAX in Portadecor veneer see p. 198
- STEEL see p. 212-217

### NOTES

- Norm PN EN 14351-2:2018-12.
- Door leaves available in 'paint yourself' option are in the same price as MINIMAX white.
- Hollow chipboard core and chipboard core have preparation for shortening as a standard
- Size '110' is available only with hollow chipboard. Glazing size is the same as for size '100'
- Double doors are available in any door leaf size combinations.
- Passive door leaves (side panels) in sizes '30', '40', '50' available only in solid option (without glazing or decorative mouldings).
- Magnetic lock is not available for a double door.

- Size '80' and '90' in investment norm (clear opening width 800, 900 mm) available as a standard - without extra charge.
- Sizes '100' and '110' require third hinge
- Reinforcement for door closer requires third hinge.
- Due to various materials use, there might be a slight colour difference between door leaf and a glazing bead
- PRIME hinges - packed with a door frame.

### EXTRA CHARGES

- size '100', '110'
- hollow chipboard core
- chipboard core
- inverse glazing
- automatic threshold seal
- ventilation grille, ventilation sleeves or ventilation undercut
- PRIME hinges (apply to dedicated door frames)
- PRIME lock with glossy faceplate (silver or gold)
- magnetic lock with stainless steel face plate
- preparation for shortening (maximum 60 mm)
- reinforcement for door closer (third hinge is required)
- stainless steel porthole
- hook lock with side pull handles (sliding doors)
- oblong pull handle for sliding doors
- caps for standard hinges
- frosted tempered glass - model M
- frosted tempered glass - model D
- frosted tempered glass - model L
- handle with an escutcheon

(see p. 224)

# LONDON, VIENNA

02



VIENNA B, White



VIENNA P, White



LONDON P



LONDON O



LONDON B



LONDON C



VIENNA P



VIENNA O



VIENNA B



VIENNA C



## AVAILABLE FINISHES

Standard paint ★★☆☆☆☆



LONDON,  
VIENNA



LONDON, VIENNA  
wood grains

## TECHNICAL INFORMATION

### DOOR LEAF CONSTRUCTION

Stabilising infill skinned with embossed HDF.

### ACCESSORIES INCLUDED IN THE DOOR LEAF PRICE

- Two or three standard barrel hinges or PRIME hinges (optionally, at extra charge)
- Lock: key lock, WC lock, or cylinder lock
- 'Chinchilla' glass
- Round pull handle (for sliding doors)

### DOOR FRAMES

#### Recommended rebated door frames:

- Porta SYSTEM in Portadecor veneer see p. 200
- MINIMAX in Portadecor veneer see p. 198
- STEEL see p. 212-217

### NOTES

- Norm PN EN 14351-2:2018-12.
- Double doors are available in any door leaf size combinations.
- We recommend handle and escutcheon, 'Royal' see p.195
- Magnetic lock is not available for a double door.
- Reinforcement for door closer requires third hinge
- Due to various materials use, there might be a slight colour difference between doorleaf and a glazing bead/muntin.
- PRIME hinges - packed with a door frame

### EXTRA CHARGES

- ventilation sleeves or ventilation undercut
- preparation for shortening (maximum 60 mm)
- magnetic lock with stainless steel faceplate
- PRIME hinges (applies to dedicated door frames)
- PRIME lock with glossy faceplate (silver or gold)
- preparation for shortening (maximum 60 mm)
- reinforcement for door closer (third hinge is required)
- hook lock with side pull handles (sliding doors)
- oblong pull handle for sliding doors
- caps for standard hinges
- handle with an escutcheon

(see p. 224)

# Porta ROYAL Premium, Porta SKANDIA Premium

02



Porta ROYAL Premium A, White



Porta ROYAL Premium A, White



model P



model A



Porta SKANDIA  
model R.0





## AVAILABLE FINISHES

Premium paint ★★★★★☆



perfectly smooth surface

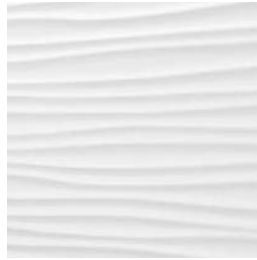

SKANDIA  
relief, model R.0

## TECHNICAL INFORMATION

### DOOR LEAF CONSTRUCTION

Stabilising infill or chipboard core (extra charge) skinned with embossed HDF.

### ACCESSORIES INCLUDED IN THE DOOR LEAF PRICE

- Rebated doors: two or three standard barrel hinges or PRIME hinges (optionally at extra charge); non-rebated: two 3D hinges
- Lock: key lock, WC lock, or cylinder lock
- Round pull handle (for sliding doors)

### DOOR FRAMES

#### Recommended rebated door frames:

- Porta SYSTEM in Premium veneer see p. 200
- MINIMAX in Premium veneer see p. 198
- STEEL see p. 212-217

#### Recommended non-rebated door frames:

- Porta SYSTEM ELEGANCE finished with Premium veneer see p. 202
- Porta SYSTEM ELEGANCE 90 degrees finished with Premium veneer see p. 202
- LEVEL finished with Premium veneer see p. 206

### NOTES

- Norm PN EN 14351-2:2018-12.
- Double doors are available in any door leaf size combinations.
- We recommend handle and escutcheon, Royal' see p.195
- Magnetic lock is not available for a double door
- Reinforcement for door closer requires third hinge
- PRIME hinges or 3D hinges - packed with a door frame

### EXTRA CHARGES

- ventilation sleeves or ventilation undercut
- chipboard core - Royal
- hollow chipboard core - Skandia
- automatic threshold seal
- preparation for shortening (maximum 60 mm)
- magnetic lock with stainless steel faceplate
- magnetic lock: white, black (for non-rebated door leaves)
- OFFER - PRIME set
- gold 3D hinges (extra charge added to door frame price)
- third 3D hinge - silver (extra charge added to door frame price)
- third 3D hinge - gold (extra charge added to door frame price)
- reinforcement for door closer (third hinge is required)
- hook lock with side pull handles (sliding doors)
- oblong pull handle for sliding doors
- caps for standard hinges
- handle with an escutcheon

(see p. 224)

# Porta VECTOR, FORM Premium

02

**TOP**  
COLLECTIONS



Porta VECTOR Premium E, White

**NOTE**

UV acrylic paint is highly resistant to:  
 - dirt (coffee, alcohol, grease)  
 - abrasion  
 - scratches  
 - impacts.

**Guarantee of colour permanence for years.  
 For the door leaf we recommend door  
 frame in UV acrylic paint.**



PREMIUM  
PAINT



HIGH  
DURABILITY



Porta VECTOR Premium V, White



VECTOR T



VECTOR A



VECTOR B



VECTOR C



VECTOR E

NEW



VECTOR J



VECTOR U



VECTOR V



VECTOR W





## AVAILABLE FINISHES

### Premium paint ★★★★★☆



### UV acrylic paint ★★★★★☆



Give free rein to your imagination! Do you have your own door concept? You can order any milling with Porta CONTRACT, details regarding bespoke orders, see page 261.



See Porta VECTOR collection:  
[www.porta.com.pl/dm/portavector.wmv](http://www.porta.com.pl/dm/portavector.wmv)

VECTOR, FORM  
Premium



decorative milling close up



automatic threshold seal

#### NOTE

If you're looking for a glazed door that matches this collection, check Porta FOCUS Premium see p. 38

## TECHNICAL INFORMATION

### DOOR LEAF CONSTRUCTION

Honeycomb or hollow chipboard core reinforced with rails and stiles (at an extra charge). The construction is skinned with HDF.

### ACCESSORIES INCLUDED IN THE DOOR LEAF PRICE

- Rebated doors: two or three standard barrel hinges, or PRIME hinges; non-rebated: two 3D hinges
- Lock: key lock, WC lock, or cylinder lock
- Round pull handle (for sliding doors)

### DOOR FRAMES

#### Recommended rebated door frames:

- Porta System finished with Premium veneer or UV acrylic paint, see p. 200
- MINIMAX finished with Premium veneer or UV acrylic paint, see p. 198

#### Recommended non-rebated door frames:

- Porta SYSTEM ELEGANCE finished with Premium veneer or UV acrylic paint see p. 202
- Porta SYSTEM ELEGANCE 90 degrees finished with Premium veneer or UV acrylic paint see p. 202
- LEVEL finished with Premium veneer or UV acrylic paint see p. 206

#### Recommended door frames with reversed rebate:

- Porta SYSTEM with reversed rebate finished with Premium veneer or UV acrylic paint see p. 176

### NOTES

- Norm PN EN 14351-2:2018-12.
- Height, 220': available models - A, B, C, E, T, U, V; core - hollow chipboard, 3 hinges as standard
- Double doors are available in any door leaf size combinations. Passive door leaves (side panels) in sizes '30', '40', '50' available only in solid option (without decorative applications)

- Magnetic lock is not available for a double door
- Reinforcement for door closer requires third hinge
- Size '100' requires third hinge
- PRIME or 3D hinges - packed with a door frame

### EXTRA CHARGES

- reversed rebate - extra charge added to door leaf price
- reversed rebate - third 3D hinge, silver, white, black (extra charge added to door frame price)
- size '100'
- hollow chipboard core
- chipboard core
- height 220
- ventilation sleeves or ventilation undercut
- preparation for shortening (maximum 60 mm)
- automatic threshold seal
- OFFER - prime set
- gold 3D hinges (extra charge added to door frame price)
- third 3D hinge - silver, white, black (extra charge added to door frame price)
- third 3D hinge - gold (extra charge added to door frame price)
- magnetic lock with stainless steel faceplate
- magnetic lock: white, black, for non-rebated door leaves
- reinforcement for a door closer (third hinge is required)
- hook lock with side pull handles (sliding doors)
- oblong pull handle for sliding doors
- caps for standard hinges
- handle with an escutcheon

(see p. 224)

# PORTA ART DECO

02



PORTA ART DECO, White, gold AZURA handle

## NOTE

UV acrylic paint is highly resistant to:

- dirt (coffee, alcohol, grease)
- abrasion
- scratches
- impacts.

**Guarantee of colour permanence for years.**

**For the door leaf we recommend door frame in UV acrylic paint.**



PREMIUM  
VARNISH

UV

HIGH  
RESISTANCE



PORTA ART DECO, White, gold AZURA handle



model 1



model 2



model 3



model 4

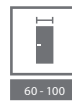

## AVAILABLE FINISHES

### Premium Varnish ★★★★★☆



### UV acrylic paint ★★★★★☆



close-up of milling  
model 1



close-up of milling  
model 2



close-up of milling  
model 1



close-up of milling  
model 2, 3, 4

## TECHNICAL INFORMATION

### DOOR LEAF DESIGN

The filling is "honeycomb" or chipboard core reinforced with an internal stile (option at extra charge). The whole is covered with HDF board.

### ACCESSORIES IN DOOR LEAF PRICE

- Rebated doors: two or three barrel hinges standard or PRIME; non-rebated doors: two 3D hinges
- Lock: standard lock option, with bathroom lock or adapted for cylinder lock
- Round handle (for sliding doors)

### DOOR FRAMES

#### Recommended rebated door frames:

- PORTA SYSTEM in Premium veneer and in UV Acrylic paint p. 200
- MINIMAX in Premium veneer and in UV Acrylic paint p. 198

#### Recommended non-rebated door frames:

- PORTA SYSTEM ELEGANCE in Premium veneer and in UV Acrylic paint p. 202
- PORTA SYSTEM ELEGANCE 90 degrees in Premium veneer and in UV Acrylic paint p. 202
- LEVEL in Premium veneer and in UV Acrylic paint p. 206

#### Recommended door frames with reverse rebate:

- PORTA SYSTEM with reverse rebate in Premium veneer and in UV Acrylic paint p. 176

### NOTES

- Standard PN-EN 14351-2:2018-12.
- **Height "220": filling - hollow chipboard core; three hinges as a standard.**
- Possibility of combining any door leaf dimensions in double-leaf doors. Passive leaf (extension) in sizes "30", "40", "50" without milling.
- Magnetic lock is not available for a double door

- With the "reinforcement for door closer" option, a third hinge is required.
- For width "100", a third hinge is required.
- PRIME or 3D hinges - packed with the door frame.

### EXTRA CHARGES

- reversed rebate – extra charge for leaf
- reversed rebate – third 3D hinge in silver (extra charge to door frame)
- reversed rebate – third 3D hinge in white, black (extra charge to door frame)
- **PROMOTION** - PRIME package without extra charge
- preparation for shortening (max. 60 mm)
- size "100"
- sliding door leaves - longitudinal handle
- sliding leaves - hook lock with side handles
- third 3D hinge in silver, white, black (extra charge for frame)
- third 3D hinge in gold (extra charge for frame)
- ventilation sleeves or ventilation undercut
- drop gasket
- filling with hollow core chipboard
- filling with solid chipboard
- door leaf height „220"
- reinforcement for door closer (third hinge required)
- black lock and black barrel hinges
- magnetic lock: white, black on non-rebated leaves
- magnetic lock with stainless steel front
- 3D hinges in gold (extra charge to door frame)
- standard hinge caps
- handle with escutcheon

(p. 235)  
(p. 224)

# Porta FOCUS Premium

02

**TOP**  
COLLECTIONS



Porta FOCUS Premium 4.A, White

**NOTE**

UV acrylic paint is highly resistant to:  
 - dirt (coffee, alcohol, grease)  
 - abrasion  
 - scratches  
 - impacts

**Guarantee of colour permanence for years.  
 For the door leaf we recommend door  
 frame in UV acrylic paint.**



PREMIUM  
PAINT



HIGH  
DURABILITY



Porta FOCUS Premium 4.A, White



model 5.A



model 5.B



model 5.C



model 4.A



model 4.B



model 4.C



Porta VECTOR  
model E  
see page 34



model 4.D



model 4.E





## AVAILABLE FINISHES

### Premium paint ★★★★★☆



### UV acrylic paint ★★★★★☆



glass - door panel joint non-rebated door



glass - door panel joint rebated door

#### NOTE

If you're looking for a flush door that matches this collection, check Porta VECTOR Premium see p. 34

## TECHNICAL INFORMATION

### DOOR LEAF CONSTRUCTION

Honeycomb or hollow chipboard core reinforced with rails and stiles (at an extra charge). The construction is skinned with HDF. Glazed models come with 8 mm thick, frosted tempered glass, which is an element of the construction.

### ACCESSORIES INCLUDED IN THE DOOR LEAF PRICE

- Rebated doors: two or three standard barrel hinges or PRIME hinges; non-rebated: two 3D hinges
- Three hinges for size '100'
- Lock: key lock, WC lock, or cylinder lock
- 8 mm thick, frosted, tempered glass
- Round pull handle (for sliding doors)

### DOOR FRAMES

#### Recommended rebated door frames:

- Porta System finished with Premium veneer or UV acrylic paint see p. 200
- MINIMAX finished with Premium veneer or UV acrylic paint see p. 198

#### Recommended non-rebated door frames:

- Porta SYSTEM ELEGANCE finished with Premium veneer or UV acrylic paint see p. 202
- Porta SYSTEM ELEGANCE 90 degrees finished with Premium veneer or UV acrylic paint see p. 202
- LEVEL finished with Premium veneer or UV acrylic paint see p. 206

#### Recommended door frames with reversed rebate:

- Porta SYSTEM with reversed rebate finished with Premium veneer or UV acrylic paint see p. 176

### NOTES

- Norm PN EN 14351-2:2018-12.
- Double doors are available in any door leaf size combinations.

- For non-rebated double door, 'active' and 'passive' door leaves must be ordered 4.B, and 4.D models are available only with hollow chipboard core, free of extra charge
- Models 4.D, 4.E are not available for double-leaf door option
- **Fixed size of glass, model 4.A**
- Magnetic lock is not available for a double door
- Ventilation undercut in glazed models is available only for Polish Norm and it is not available for reversed rebate option
- Size '100' requires third hinge
- PRIME or 3D hinges - packed with a door frame

### EXTRA CHARGES

- size '100'
- black glazing - model 4.A
- reversed rebate - extra charge added to door leaf price
- reversed rebate - third 3D hinge, silver, white, black (extra charge added to door frame price)
- inversed glazing
- hollow chipboard core
- ventilation undercut
- preparation for shortening - group 5 models (maximum 60 mm)
- OFFER - prime set
- gold 3D hinges (extra charge added to door frame price)
- third 3D hinge - silver, white, black (extra charge added to door frame price)
- third 3D hinge - gold (extra charge added to door frame price)
- magnetic lock with stainless steel faceplate
- magnetic lock: white, black for non-rebated door leaves
- hook lock with side pull handles (sliding doors)
- oblong pull handle for sliding doors
- caps for standard hinges (set for 1 PCs)
- handle with an escutcheon

(see p. 224)

# Porta DESIRE UV

02

**TOP**  
COLLECTIONS



Porta DESIRE 2, White

**NOTE**

UV acrylic paint is highly resistant to:  
 - dirt (coffee, alcohol, grease)  
 - abrasion  
 - scratches  
 - impacts

**Guarantee of colour permanence for years.  
 For the door leaf we recommend door  
 frame in UV acrylic paint.**

**UV**  
HIGH  
DURABILITY



Porta DESIRE 3, White with a black decorative door inlay



model 1



model 2



model 3  
black decorative  
inlays



model 4  
black decorative  
inlays



model 3  
silver decorative  
inlays



model 4  
silver decorative  
inlays





## AVAILABLE FINISHES

UV acrylic paint ★★★★★☆



decorative milling model 2



Black decorative inlay, model 3.  
Silver decorative inlays are also available



golden decorative inlay, model 3

## TECHNICAL INFORMATION

### DOOR LEAF CONSTRUCTION

Honeycomb or hollow chipboard core reinforced with glued wood rails and stiles (at extra charge). The construction is skinned with HDF.

**Satin look, smooth surface is achieved thanks to UV painting technology.**

Model 3 and 4 with decorative door inlays (inlays colours: silver, gold or black).

### ACCESSORIES INCLUDED IN THE DOOR LEAF PRICE

- Rebated doors: three standard barrel hinges or PRIME hinges; non-rebated: two 3D hinges
- Lock with silver or golden glossy plate: key lock, WC lock, or cylinder lock
- Preparation for shortening (maximum 60 mm)

### DOOR FRAMES

#### Recommended rebated door frames:

- Porta System finished with Premium veneer or UV acrylic paint, see p. 200
- MINIMAX finished with Premium veneer or UV acrylic paint, see p. 198

#### Recommended non-rebated door frames:

- Porta SYSTEM ELEGANCE finished with Premium veneer or UV acrylic paint see p. 202
- Porta SYSTEM ELEGANCE 90 degrees finished with Premium veneer or UV acrylic paint see p. 202
- LEVEL finished with Premium veneer or UV acrylic paint see p. 206

#### Recommended door frames with reversed rebate:

- Porta SYSTEM with reversed rebate finished with Premium veneer or UV acrylic paint see p. 176

### NOTES

- Norm PN EN 14351-2:2018-12.
- **Height, 220': core - hollow chipboard; 3 hinges as a standard**
- Double doors are available in any door leaf size combinations.
- Magnetic lock is not available for a double door
- Size, 100' requires third hinge
- PRIME or 3D hinges - packed with a door frame.

### EXTRA CHARGES

- size '100'
- reversed rebate - third 3D hinge, silver, white, black (extra charge added to door frame price)
- automatic threshold seal
- height 220
- ventilation undercut
- preparation for shortening - group 5 models (maximum 60 mm)
- gold 3D hinges (extra charge added to door frame price)
- third 3D hinge - silver (extra charge added to door frame price)
- third 3D hinge - gold (extra charge added to door frame price)
- magnetic lock with stainless steel faceplate
- magnetic lock: white, black for non-rebated door leaves
- hook lock with side pull handles (sliding doors)
- oblong pull handle for sliding doors
- chipboard core instead of hollow chipboard core (height 220)
- handle with an escutcheon

(see p. 224)

# Porta GRANDE UV

02

**TOP**  
COLLECTIONS

Porta GRANDE G.4, White

**WE RECOMMEND**

Frame and panel construction of Grande collection and new UV painting technology guarantee long-lasting durability.

**NOTE**

UV acrylic paint is highly resistant to:

- dirt (coffee, alcohol, grease)
- abrasion
- scratches
- impacts

**Guarantee of colour permanence for years.**  
**For the door leaf we recommend door frame in UV acrylic paint.**

**UV**  
HIGH  
DURABILITY

Porta GRANDE G.4, White



model G.0



model G.4



model A.0



model A.1

model A.1  
with a mirror

model C.0



model B.0



model B.1



model B.3



model D.0

Check more models  
from this collection  
on a website



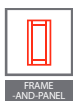

## AVAILABLE FINISHES

### UV acrylic paint ★★★★★☆



## AVAILABLE FINISHES OF DECORATIVE SLATS

### Solid Oak ★★★★★☆



### Natural veneer - Oak ★★★★★☆



### Portaperfect 3D veneer ★★★★★☆

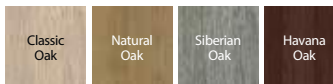

### Brushed aluminium



glazing of G.4 model - glass panel recessed in comparison to the surface of a door panel



flush panel



Decorative slat made of solid oak, flush with the surface of door leaf panel, horizontal graining



Model G.0 - decorative slat (Portaperfect finish or Natural Oak) is recessed in comparison to the surface of a door leaf panel. Vertical graining is optional at extra charge.



Model G.0 - decorative slat (brushed aluminium) is recessed in comparison to the surface of a door leaf panel. Vertical graining is optional at extra charge.

## TECHNICAL INFORMATION

### DOOR LEAF CONSTRUCTION

#### Satin look, smooth surface is achieved thanks to UV painting technology.

It is possible to produce model A.1 with a mirror on one or on both sides. If the mirror is only on one side, there is a solid board on another side.

There is a possibility to choose decorative slats made of solid oak, which are flush with the surface of door leaf panels (model F). Another option are slats in synthetic or natural veneer or brushed aluminium which are recessed in comparison to the surface of door leaf panels (model G).

### ACCESSORIES INCLUDED IN THE DOOR LEAF PRICE

- Rebated doors: three standard barrel hinges or PRIME hinges; non-rebated: two 3D hinges
- Lock with silver or glossy gold plate: key lock, WC lock, or cylinder lock
- Frosted, tempered glass
- Round pull handle (for sliding doors)
- Preparation for shortening (maximum 60 mm)

### DOOR FRAMES

#### Recommended rebated door frames:

- Porta System finished with UV acrylic paint, see p. 200
- MINIMAX finished with UV acrylic paint, see p. 198

#### Recommended non-rebated door frames:

- Porta SYSTEM ELEGANCE finished with Premium veneer or UV acrylic paint, see p. 202
- Porta SYSTEM ELEGANCE 90 degrees finished with Premium veneer or UV acrylic paint, see p. 202
- LEVEL finished with Premium veneer or UV acrylic paint, see p. 206

#### Recommended door frames with reversed rebate:

- Porta SYSTEM with reversed rebate finished with Premium veneer or UV acrylic paint, see p. 176

### NOTES

- Norm PN EN 14351-2:2018-12.
- Double doors are available in any door leaf size combinations.
- Magnetic lock is not available for a double door
- Size '100' requires third hinge
- PRIME or 3D hinges - packed with a door frame

### EXTRA CHARGES

- decorative slat in Portaperfect finish - model G (white leaf)
- decorative slat - brushed aluminium - model G (white leaf)
- decorative slat in natural veneer - model G (white leaf)
- size '100'
- ventilation undercut
- gold 3D hinges (extra charge added to door frame price)
- third 3D hinge - silver, white, black (extra charge added to door frame price)
- third 3D hinge - gold (extra charge added to door frame price)
- magnetic lock with stainless steel faceplate
- magnetic lock: white, black (for non-rebated doors)
- mirror on one side
- mirror on both sides
- reversed rebate - third 3D hinge, silver, white, black (extra charge added to door frame price)
- hook lock with side pull handles (sliding doors)
- oblong pull handle for sliding doors
- handle with an escutcheon

(see p. 224)

# Porta DUO

02



Porta DUO 4.0, White UV paint with Natural Oak

## WE RECOMMEND

Combination of white colour with a vertical panel in natural or ligniform veneer is a timeless and glamorous interior arrangement. It's suitable for homes and public areas, regardless of their style.

## NOTE

UV acrylic paint is highly resistant to:

- dirt (coffee, alcohol, grease)
- abrasion
- scratches
- impacts

**Guarantee of colour permanence for years. For the door leaf we recommend door frame in UV acrylic paint.**

**UV**  
HIGH  
DURABILITY



Porta DUO 4.0, White UV paint with Natural Oak



model 4.0



model 4.A  
with a glass



model 4.0



model 4.A  
with a glass panel

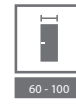

## AVAILABLE FINISHES

### UV acrylic paint ★★★★★☆



## AVAILABLE FINISHES - PANEL

### Portadecor veneer ★★★★★☆



### Natural veneer - Oak ★★★★★☆



### Portaperfect 3D veneer ★★★★★☆



### Natural Satin Oak Veneer ★★★★★☆



### Natural Select Veneer ★★★★★☆



glass-panel joint



panels joint

## TECHNICAL INFORMATION

### DOOR LEAF CONSTRUCTION

The door leaf consists of: a wide, painted panel and a narrow stile covered with natural or synthetic veneer. For a glazed model we use 8 mm thick, frosted, tempered glass which is a construction element of the door leaf. Painted white part has a satin smooth surface which is achieved thanks to UV painting technology. Natural veneer is protected with ecological water varnishes, hardened under UV lamp (semi-matt effect).

### ACCESSORIES INCLUDED IN THE DOOR LEAF PRICE

- Two 3D hinges
- Lock with silver or glossy gold faceplate: key lock, WC lock, or cylinder lock
- Preparation for shortening, model 4.0 maximum 60 mm
- 8 mm, frosted, tempered glass

### DOOR FRAMES

- Porta SYSTEM ELEGANCE finished with Premium veneer or UV acrylic paint see p. 202
- Porta SYSTEM ELEGANCE 90 degrees finished with Premium veneer or UV acrylic paint see p. 202
- LEVEL finished with Premium veneer or UV acrylic paint see p. 206

### NOTES

- Norm PN EN 14351-2:2018-12.
- Double doors are available in any door leaf size combinations.
- For a double door, 'active' and 'passive' door leaves must be ordered
- Magnetic lock is not available for a double door
- **Black glazing is available for model 4.A (at extra charge)**
- Fixed size of glass, model 4.A
- Ventilation undercut in glazed models is available only for Polish Norm
- Size '100' requires third hinge
- PRIME or 3D hinges - packed with a door frame

### EXTRA CHARGES

- black glazing - model 4.A
- size '100'
- ventilation undercut
- gold 3D hinges (extra charge added to door frame price)
- third 3D hinge - silver, white, black (extra charge added to door frame price)
- third 3D hinge - gold (extra charge added to door frame price)
- magnetic lock with stainless steel faceplate
- handle with an escutcheon

(see p. 224)

# Porta HIDE

02



Porta HIDE, 1.1

## WE RECOMMEND

Porta HIDE opens up new possibilities for interior designs. It allows you to install the door leaf and frame within the wall to be then decorated in the same finish as the wall (eg. paint, wallpaper) to create a hidden door.



Porta HIDE, 1.1, White



model 1.1



## AVAILABLE FINISHES

### Premium paint ★★★★★☆☆



### Primer paint for self painting and wallpapering



Non-rebated door leaf (outwards outwards) - right door



Reversed rebate (opening inwards) - left door

## TECHNICAL INFORMATION

### DOOR LEAF CONSTRUCTION

Non-rebated door leaf (opening outwards) or door leaf with reversed rebate (opening inwards). Honeycomb or hollow core (at extra charge) reinforced with rails and stiles. The construction is skinned with HDF. Available two types of finish:

- Prime finish ready for painting or wallpapering
- White Premium Paint finish

### DOOR FRAMES

Hidden aluminium door frame, ready for painting with wall paint. It's dedicated for 40 mm thick, wooden door leaves. Can be assembled on concrete wall or plasterboard wall. Dimensions see page 244, Table 8.

### DOORS INCLUDE

- Door leaf
- Two 3D hinges
- Three 3D hinges for hollow core
- Magnetic lock: key lock, WC lock or cylinder lock
- Hidden aluminium door frame
- Preparation for shortening is available for hollow chipboard core, maximum 60 mm

### NOTES

- Technical Assessment AT-15-6515/2016, ITB Warsaw. - door leaf
- Technical Assessment ITB-KOT-2019/1076 edition 1 - door frame
- Dedicated 3D hinge
- Automatic threshold seal is available for a door leaf with hollow chipboard core

### EXTRA CHARGES

- ventilation undercut
- automatic threshold seal
- hollow core
- handle with an escutcheon

(see p. 224)

# PORTA VERTE HOME BLACK

03



PORTA VERTE HOME N.3, transparent glass, LUNA handle black



PORTA VERTE HOME N.3, Black Handle LUNA black



model B.5



model L.4



model N.3





## AVAILABLE FINISHES

**SUPER MATT veneer** ★★★★★☆



transparent or matt glass  
(at extra charge)

## TECHNICAL INFORMATION

### DOOR LEAF DESIGN

Depending on the design, the door leaf consist of horizontal stiles and panels and frosted glass made of tempered glass. Matt glass with a thickness of 4 mm.

### ACCESSORIES IN DOOR LEAF PRICE

- Lock available in the following variants: standard lock option, with bathroom lock or adapted for lock cylinder or without a keyhole
- Rebated doors: three barrel hinges standard or PRIME (option at extra charge); non-rebated doors: two 3D hinges
- Transparent or frosted tempered glass (at extra charge)
- Preparation for shortening, maximum 30 mm
- Round handle (for sliding doors)

### DOOR FRAMES

#### Recommended rebated door frames:

- PORTA SYSTEM p. 200

#### Recommended non-rebated door frames:

- PORTA SYSTEM ELEGANCE p. 202

### NOTES

- Standard PN-EN 14351-2:2018-12.
- Double doors are available in any door leaf size combinations. Active and passive door leaf should be ordered with double-leaf, non-rebated doors.

- Magnetic lock is not available for a double door.
- For width "100", a third hinge is required.
- PRIME or 3D hinges – packed with the door frame.

### EXTRA CHARGES

- size "100"
- transparent glass model B.5
- transparent painted glass model B.5
- transparent glass model L.4 - 1 pc.
- transparent glass model N.3 - 1 pc.
- sliding door leaves – longitudinal handle
- sliding door leaves – hook lock with side handles
- third 3D hinge in silver, white, black (extra charge for frame)
- third 3D hinge in gold (extra charge for frame)
- ventilation sleeves or undercut
- black lock and black barrel hinges
- magnetic lock: white, black on non-rebated doors.
- magnetic lock with stainless steel faceplate
- PRIME lock with glossy front (silver or gold)
- 3D hinges in gold (extra charge for frame)
- PRIME hinges (for dedicated door frames)
- standard hinge caps
- handle with escutcheon

(p. 235)  
(p. 224)

# Porta Verte HOME, group B

03



Porta Verte HOME B.5, Wenge White



Porta Verte HOME B.0, Wenge White



model B.1



model B.2



model B.5

Check more models  
from this collection  
on a website





## AVAILABLE FINISHES

### Portadecor veneer ★★★★★☆



### Portasynchro 3D veneer ★★★★★☆

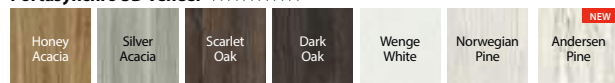

### Premium veneer ★★★★★☆



### Portaperfect 3D veneer ★★★★★☆

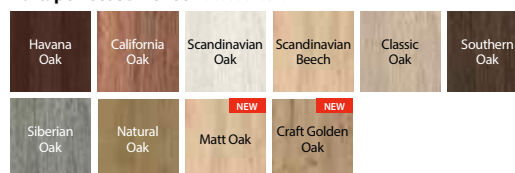

### Portalamino ★★★★★☆



Porta Verte HOME



model B.0 - slim panel



model B.5 - dedicated frosted glass panel with transparent stripes

## TECHNICAL INFORMATION

### DOOR LEAF CONSTRUCTION

Door leaves contain rails, slim panels and 4 mm thick, frosted, tempered glass. Combination of those depends on a model.

### ACCESSORIES INCLUDED IN THE DOOR LEAF PRICE

- Lock key lock, WC lock, cylinder lock, handle only
- Rebated doors: three standard barrel hinges or PRIME hinges (at extra charge); non-rebated: two 3D hinges
- Frosted tempered glass
- Preparation for shortening (maximum 30 mm)
- Round pull handle (for sliding doors)

### DOOR FRAMES

#### Recommended rebated door frames:

- Porta SYSTEM see p. 200
- MINIMAX see p. 198
- STEEL see p. 212-217

#### Recommended non-rebated door frames:

- Porta SYSTEM ELEGANCE see p. 202
- Porta SYSTEM ELEGANCE 90 degrees, finished with Premium veneer see p. 202
- LEVEL see p. 206

### NOTES

- Norm PN EN 14351-2:2018-12.
- Double doors are available in any door leaf size combinations. For a non-rebated double door, 'active' and 'passive' door leaves must be ordered
- Magnetic lock is not available for a double door
- Size, 100' requires third hinge
- PRIME or 3D hinges - packed with a door frame

### EXTRA CHARGES

- size '100'
- ventilation undercut or ventilation sleeves
- PRIME hinges (for dedicated door frames)
- PRIME lock with glossy faceplate (silver or gold)
- gold 3D hinges (extra charge added to a door frame price)
- third 3D hinge - silver, white, black (extra charge added to a door frame price)
- third 3D hinge - gold (extra charge added to a door frame price)
- magnetic lock with stainless steel faceplate
- magnetic lock: white, black (for non-rebated doors)
- hook lock with side pull handles (sliding doors)
- oblong pull handle for sliding doors
- caps for standard hinges
- handle with an escutcheon

(see p. 224)



# Porta Verte HOME, group C

03

TOP  
COLLECTIONS



Porta Verte HOME C.5, Scarlet Oak



Porta Verte HOME C.5, Scarlet Oak



model C.0



model C.1



model C.2



model C.3



model C.4



model C.5



model C.0  
decorative inlays



model C.5  
decorative inlays

Check more models  
from this collection  
on a website





## AVAILABLE FINISHES

### Portadecor veneer ★★★★★☆



### Portasynchro 3D veneer ★★★★★☆

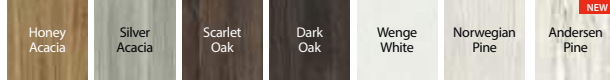

### Premium veneer ★★★★★☆



### Portaperfect 3D veneer ★★★★★☆

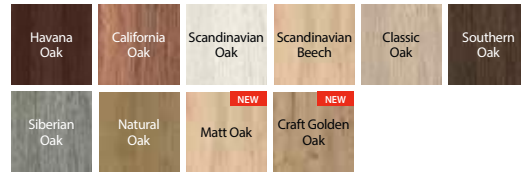

### Portalamino ★★★★★☆

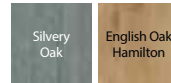

Porta Verte HOME



decorative inlays  
- aluminium colour



frosted tempered glass

## TECHNICAL INFORMATION

### DOOR LEAF CONSTRUCTION

Door leaves contain rails, slim panels and 4 mm thick, frosted, tempered glass. Combination of those depends on a model.

### ACCESSORIES INCLUDED IN THE DOOR LEAF PRICE

- Lock: key lock, WC lock, cylinder lock, handle only
- Rebated doors: three standard barrel hinges or PRIME hinges (at extra charge); non-rebated: two 3D hinges
- Frosted tempered glass
- Preparation for shortening (maximum 30 mm)
- Round pull handle (for sliding doors)

### DOOR FRAMES

#### Recommended rebated door frames:

- Porta SYSTEM see p. 200
- MINIMAX see p. 198
- STEEL see p. 212-217

#### Recommended non-rebated door frames:

- Porta SYSTEM ELEGANCE see p. 202
- Porta SYSTEM ELEGANCE 90 degrees, finished with Premium veneer see p. 202
- LEVEL see p. 206

### NOTES

- Norm PN EN 14351-2:2018-12.
- Double doors are available in any door leaf size combinations. For a double non-rebated door, 'active' and 'passive' door leaves must be ordered.
- Magnetic lock is not available for a double door
- Size, 100' requires third hinge
- PRIME or 3D hinges - packed with a door frame

### EXTRA CHARGES

- size '100'
- ventilation undercut or ventilation sleeves
- PRIME hinges (for dedicated door frames)
- PRIME lock with glossy faceplate (silver or gold)
- gold 3D hinges (extra charge added to a door frame price)
- third 3D hinge - silver, white, black (extra charge added to a door frame price)
- third 3D hinge - gold (extra charge added to a door frame price)
- magnetic lock with stainless steel faceplate
- magnetic lock: white, black (for non-rebated doors)
- hook lock with side pull handles (sliding doors)
- oblong pull handle for sliding doors
- caps for standard hinges
- handle with an escutcheon

(see p. 224)

# Porta Verte HOME, group D

03

TOP  
COLLECTIONS



Porta Verte HOME D.7, Scandinavian Oak



Porta Verte HOME D.7, Scandinavian Oak



model D.0



model D.1



model D.2



model D.3



model D.4



model D.5



model D.6



model D.7



model D.0  
decorative inlays



model D.7  
decorative inlays

Check more models  
from this collection  
on a website





## AVAILABLE FINISHES

### Portadecor veneer ★★★★★☆



### Portasynchro 3D veneer ★★★★★☆

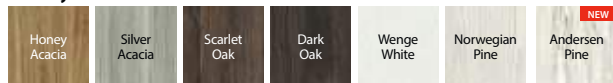

### Premium veneer ★★★★★☆



### Portaperfect 3D veneer ★★★★★☆

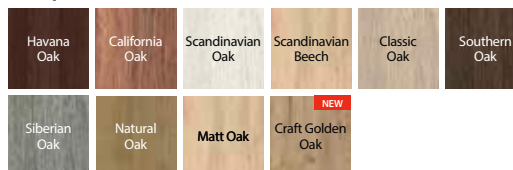

### Portalamino ★★★★★☆

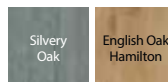

Porta Verte HOME



decorative inlays  
- aluminium colour



frosted tempered glass panel

## TECHNICAL INFORMATION

### DOOR LEAF CONSTRUCTION

Door leaves contain rails, slim panels and 4 mm thick, frosted, tempered glass. Combination of those depends on a model.

### ACCESSORIES INCLUDED IN THE DOOR LEAF PRICE

- Lock key lock, WC lock, cylinder lock, handle only
- Rebated doors: three standard barrel hinges or PRIME hinges (at extra charge); non-rebated: two 3D hinges
- Frosted tempered glass
- Preparation for shortening (maximum 30 mm)
- Round pull handle (for sliding doors)

### DOOR FRAMES

#### Recommended rebated door frames:

- Porta SYSTEM see p. 200
- MINIMAX see p. 198
- STEEL see p. 212-217

#### Recommended non-rebated door frames:

- Porta SYSTEM ELEGANCE see p. 202
- Porta SYSTEM ELEGANCE 90 degrees, finished with Premium veneer see p. 202
- LEVEL see p. 206

### NOTES

- Norm PN EN 14351-2:2018-12.
- Double doors are available in any door leaf size combinations. For a double non-rebated door, 'active' and 'passive' door leaves must be ordered.
- Magnetic lock is not available for a double door
- Size, 100' requires third hinge
- PRIME or 3D hinges - packed with a door frame

### EXTRA CHARGES

- size '100'
- ventilation undercut or ventilation sleeves
- PRIME hinges (for dedicated door frames)
- PRIME lock with glossy faceplate (silver or gold)
- gold 3D hinges (extra charge added to a door frame price)
- third 3D hinge - silver, white, black (extra charge added to a door frame price)
- third 3D hinge - gold (extra charge added to a door frame price)
- magnetic lock with stainless steel faceplate
- magnetic lock: white, black (for non-rebated doors)
- hook lock with side pull handles (sliding doors)
- oblong pull handle for sliding doors
- caps for standard hinges
- handle with an escutcheon

(see p. 224)

# Porta Verte HOME, group E

03



Porta Verte HOME E.0 i E.0 with a blackboard, Norwegian Pine



Porta Verte HOME E.0, Norwegian Pine



model E.0



model E.1



model E.5



model E.0  
blackboard





## AVAILABLE FINISHES

### Portadecor veneer ★★☆☆☆☆



### Portasynchro 3D veneer ★★☆☆☆☆

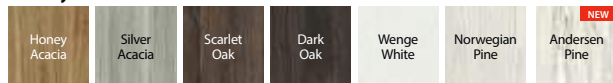

### Portaperfect 3D veneer ★★★★★☆

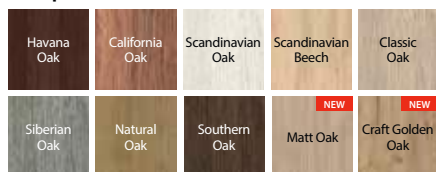

an option with a magnetic blackboard for drawing with chalk markers (this option is available for E.0 model for one side, rebated version only)



glazing, model E.5

## TECHNICAL INFORMATION

### DOOR LEAF CONSTRUCTION

Door leaves contain rails, slim panels and 4 mm thick, frosted, tempered glass. Combination of those depends on a model.

### ACCESSORIES INCLUDED IN THE DOOR LEAF PRICE

- Lock: key lock, WC lock, cylinder lock, handle only
- Rebated doors: three standard barrel hinges or PRIME hinges (at extra charge); non-rebated: two 3D hinges
- Frosted tempered glass
- Preparation for shortening (maximum 30 mm)
- Round pull handle (for sliding doors)

### DOOR FRAMES

#### Recommended rebated door frames:

- Porta SYSTEM see p. 200
- MINIMAX see p. 198
- STEEL see p. 212-217

#### Recommended non-rebated door frames:

- Porta SYSTEM ELEGANCE see p. 202
- LEVEL see p. 206

### NOTES

- Norm PN EN 14351-2:2018-12.
- Double doors are available in any door leaf size combinations. For a double non-rebated door, 'active' and 'passive' door leaves must be ordered
- Magnetic lock is not available for a double door
- Size '100' requires third hinge
- Model E.0 with the blackboard is not available in size '100'
- PRIME or 3D hinges - packed with a door frame

### EXTRA CHARGES

- size '100'
- ventilation undercut or ventilation sleeves
- PRIME hinges (for dedicated door frames)
- RIME lock with glossy faceplate (silver or gold)
- gold 3D hinges (extra charge added to a door frame price)
- third 3D hinge - silver, white, black (extra charge added to a door frame price)
- third 3D hinge - gold (extra charge added to a door frame price)
- magnetic lock with stainless steel faceplate
- magnetic lock: white, black (for non-rebated doors)
- hook lock with side pull handles (sliding doors)
- oblong pull handle for sliding doors
- caps for standard hinges
- handle with an escutcheon

(see p. 224)

# Porta Verte HOME, group G

03

TOP  
COLLECTIONS



Porta Verte HOME G.4, Portadecor veneer, White



Porta Verte HOME G.4, White



model G.0



model G.1



model G.2



model G.3



model G.4



model G.0  
decorative inlays



model G.4  
decorative inlays

Check more models  
from this collection  
on a website





## AVAILABLE FINISHES

### Portadecor veneer ★★☆☆☆☆



### Portasynchro 3D veneer ★★☆☆☆☆

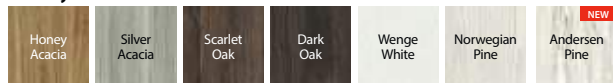

### Portaperfect 3D veneer ★★★★★☆

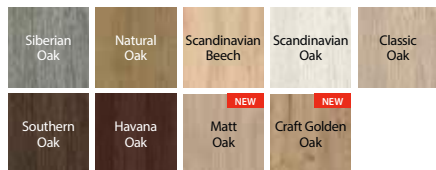

## AVAILABLE FINISHES OF DECORATIVE SLATS

### Portaperfect 3D veneer ★★★★★☆

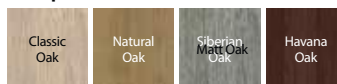

### Brushed aluminium



Porta Verte HOME



glazing, model G.4



decorative inlays  
- aluminium colour



Model G.0 - decorative slat (Portaperfect finish) is recessed in comparison to the surface of a door leaf panel. Vertical graining is optional at extra charge.



Model G.0 - decorative slat (brushed aluminium) is recessed in comparison to the surface of a door leaf panel. Vertical graining is optional at extra charge.

## TECHNICAL INFORMATION

### DOOR LEAF CONSTRUCTION

Door leaves contain rails, slim panels and 4 mm thick, frosted, tempered glass. Combination of those depends on a model.

For models in white finishes you can choose decorative slats in two options: Portaperfect veneer or brushed aluminium (at an extra charge).

### ACCESSORIES INCLUDED IN THE DOOR LEAF PRICE

- Lock: key lock, WC lock, cylinder lock, handle only
- Rebated doors: three standard barrel hinges or PRIME hinges (at extra charge); non-rebated: two 3D hinges
- Frosted tempered glass
- Preparation for shortening (maximum 30 mm)
- Round pull handle (for sliding doors)

### DOOR FRAMES

#### Recommended rebated door frames:

- Porta SYSTEM see p. 200
- MINIMAX see p. 198
- STEEL see p. 212-217

#### Recommended non-rebated door frames:

- Porta SYSTEM ELEGANCE see p. 202
- LEVEL see p. 206

### NOTES

- Norm PN EN 14351-2:2018-12.
- Double doors are available in any door leaf size combinations. For a double non-rebated door, 'active' and 'passive' door leaves must be ordered.
- Magnetic lock is not available for a double door
- Size '100' requires third hinge
- PRIME or 3D hinges - packed with a door frame

### EXTRA CHARGES

- decorative slat Portaperfect finish (white door leaf)
- decorative slat, brushed aluminium (white door leaf)
- size '100'
- ventilation undercut or ventilation sleeves
- PRIME hinges (for dedicated door frames)
- PRIME lock with glossy faceplate (silver or gold)
- gold 3D hinges (extra charge added to a door frame price)
- third 3D hinge - silver, white, black (extra charge added to a door frame price)
- third 3D hinge - gold (extra charge added to a door frame price)
- magnetic lock with stainless steel faceplate
- magnetic lock: white, black (for non-rebated doors)
- hook lock with side pull handles (sliding doors)
- oblong pull handle for sliding doors
- caps for standard hinges
- handle with an escutcheon

(see p. 224)



# Porta Verte HOME, group H

03

**TOP**  
COLLECTIONS

Porta Verte HOME H.5, Natural Oak



Porta Verte HOME H.5, Natural Oak



model H.0



model H.1



model H.2



model H.3



model H.4



model H.5

**WE RECOMMEND!**

RUMBA handle with an escutcheon for 0,01 PLN  
- only with Porta Verte HOME group H\*.



RUMBA handle

+

standard profile  
escutcheon

or

euro profile  
escutcheon

or



WC escutcheon

Special offer terms&conditions: <https://www.porta.com.pl/do-pobrania>

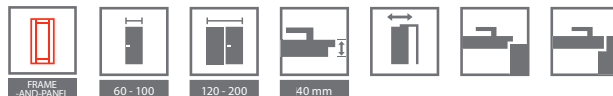

## AVAILABLE FINISHES

### Portadecor veneer ★★☆☆☆☆



### Portasynchro 3D veneer ★★☆☆☆☆

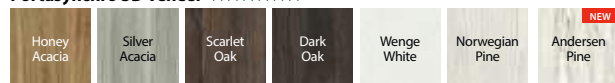

### Portaperfect 3D veneer ★★★★★☆

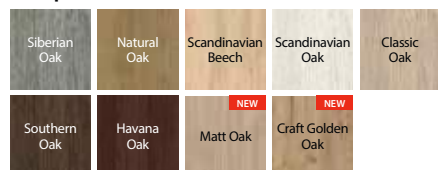

## AVAILABLE FINISHES OF DECORATIVE SLATS

### Portaperfect 3D veneer ★★★★★☆

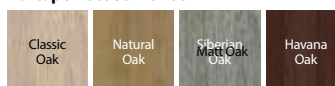

### Brushed aluminium



Porta Verte HOME



model H.0 - slim panel



model H.5 - glazing



Model H.0 - decorative slat (Portaperfect finish) is recessed in comparison to the surface of a door leaf panel. Vertical graining is optional at extra charge.



Model H.0 - decorative slat (brushed aluminium) is recessed in comparison to the surface of a door leaf panel. Vertical graining is optional at extra charge.

## TECHNICAL INFORMATION

### DOOR LEAF CONSTRUCTION

Door leaves contain rails, slim panels and 4 mm thick, frosted, tempered glass. Combination of those depends on a model. For models in white finishes you can choose decorative slats in two options: Portaperfect veneer or brushed aluminium (at extra charge).

### ACCESSORIES INCLUDED IN THE DOOR LEAF PRICE

- Lock: key lock, WC lock, cylinder lock, handle only
- Rebated doors: three standard barrel hinges or PRIME hinges (at extra charge); non-rebated: two 3D hinges
- Frosted tempered glass
- Preparation for shortening (maximum 30 mm)
- Round pull handle (for sliding doors)

### DOOR FRAMES

#### Recommended rebated door frames:

- Porta SYSTEM see p. 200
- MINIMAX see p. 198
- STEEL see p. 212-217

#### Recommended non-rebated door frames:

- Porta SYSTEM ELEGANCE see p. 202
- LEVEL see p. 206

### NOTES

- Norm PN EN 14351-2:2018-12.
- Double doors are available in any door leaf size combinations. For a double non-rebated door, 'active' and 'passive' door leaves must be ordered
- Magnetic lock is not available for a double door
- Size '100' requires third hinge
- PRIME or 3D hinges - packed with a door frame

### EXTRA CHARGES

- decorative slat Portaperfect finish (white door leaf)
- decorative slat, brushed aluminium (white door leaf)
- size '100'
- ventilation undercut or ventilation sleeves
- PRIME hinges (for dedicated door frames)
- PRIME lock with glossy faceplate (silver or gold)
- gold 3D hinges (extra charge added to a door frame price)
- third 3D hinge - silver, white, black (extra charge added to a door frame price)
- third 3D hinge - gold (extra charge added to a door frame price)
- magnetic lock with stainless steel faceplate
- magnetic lock: white, black (for non-rebated doors)
- hook lock with side pull handles (sliding doors)
- oblong pull handle for sliding doors
- caps for standard hinges
- handle with an escutcheon

(see p. 224)



# Porta Verte HOME, group J

03

TOP  
COLLECTIONS



Porta Verte HOME J.6, White



Porta Verte HOME J.6, White



model J.0



model J.1



model J.2



model J.4



model J.5



model J.6



## AVAILABLE FINISHES

### Portadecor veneer ★★☆☆☆☆



### Portasynchro 3D veneer ★★☆☆☆☆

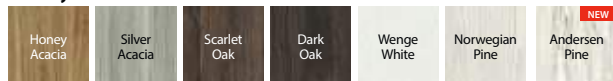

### Portaperfect 3D veneer ★★★★★☆

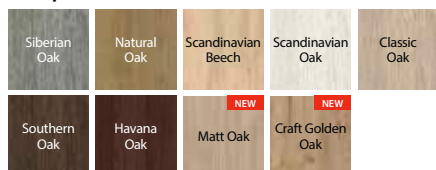

## AVAILABLE FINISHES OF DECORATIVE SLATS

### Portaperfect 3D veneer ★★★★★☆

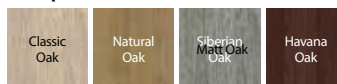

### Brushed aluminium



Porta Verte HOME



model J.6 - slim panel



model J.6 - glazing



Model J.0 - decorative slat (Portaperfect finish) is recessed in comparison to the surface of a door leaf panel. Vertical graining is optional at extra charge.



Model J.0 - decorative slat (brushed aluminium) is recessed in comparison to the surface of a door leaf panel. Vertical graining is optional at extra charge.

## TECHNICAL INFORMATION

### DOOR LEAF CONSTRUCTION

Door leaves contain rails, slim panels and 4 mm thick, frosted, tempered glass. Combination of those depends on a model.

For models in white finishes you can choose decorative slats in two options: Portaperfect veneer or brushed aluminium (at extra charge).

### ACCESSORIES INCLUDED IN THE DOOR LEAF PRICE

- Lock: key lock, WC lock, cylinder lock, handle only
- Rebated doors: three standard barrel hinges or PRIME hinges (at extra charge); non-rebated: two 3D hinge
- Frosted tempered glass
- Preparation for shortening (maximum 30 mm)
- Round pull handle (for sliding doors)

### DOOR FRAMES

#### Recommended rebated door frames:

- Porta SYSTEM see p. 200
- MINIMAX see p. 198
- STEEL see p. 212-217

#### Recommended non-rebated door frames:

- Porta SYSTEM ELEGANCE see p. 202
- LEVEL see p. 206

### NOTES

- Norm PN EN 14351-2:2018-12.
- Double doors are available in any door leaf size combinations. For a double non-rebated door, 'active' and 'passive' door leaves must be ordered.
- Magnetic lock is not available for a double door
- Size '100' requires third hinge
- PRIME or 3D hinges - packed with a door frame

### EXTRA CHARGES

- decorative slat Portaperfect finish (white door leaf)
- decorative slat, brushed aluminium (white door leaf)
- size '100'
- ventilation undercut or ventilation sleeves
- PRIME hinges (for dedicated door frames)
- PRIME lock with glossy faceplate (silver or gold)
- gold 3D hinges (extra charge added to a door frame price)
- third 3D hinge - silver, white, black (extra charge added to a door frame price)
- third 3D hinge - gold (extra charge added to a door frame price)
- magnetic lock with stainless steel faceplate
- magnetic lock: white, black (for non-rebated doors)
- hook lock with side pull handles (sliding doors)
- oblong pull handle for sliding doors
- caps for standard hinges
- handle with an escutcheon

(see p. 224)



# Porta Verte HOME, group L and N

03



Porta Verte HOME N.3, Silver Acacia



Porta Verte HOME L.4, Silver acacia



model L.0



model L.1



model L.2



model L.3



model N.0



model N.1



model N.2



model N.3





## AVAILABLE FINISHES

### Portadecor veneer ★★☆☆☆☆



### Portasynchro 3D veneer ★★☆☆☆☆

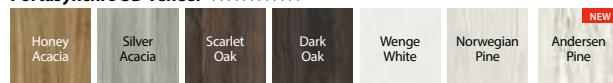

### Portaperfect 3D veneer ★★★★★☆

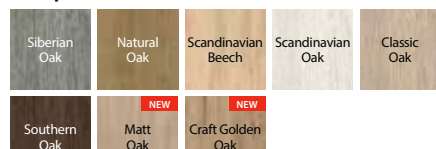

Porta Verte  
HOME



model L.0 - slim panel



model L.4 - glazing



model N.0 - slim panel



model N.3 - slim panel

## TECHNICAL INFORMATION

### DOOR LEAF CONSTRUCTION

Door leaves contain rails, slim panels and 4 mm thick, frosted, tempered glass. Combination of those depends on a model.

### ACCESSORIES INCLUDED IN THE DOOR LEAF PRICE

- Lock: key lock, WC lock, cylinder lock, handle only
- Rebated doors: three standard barrel hinges or PRIME hinges (at extra charge); non-rebated: two 3D hinges
- Frosted tempered glass
- Preparation for shortening (maximum 30 mm)
- Round pull handle (for sliding doors)

### DOOR FRAMES

#### Recommended rebated door frames:

- Porta SYSTEM see p. 200
- MINIMAX see p. 198
- STEEL see p. 214-217

#### Recommended non-rebated door frames:

- Porta SYSTEM ELEGANCE see p. 202
- LEVEL see p. 206

### NOTES

- Norm PN EN 14351-2:2018-12.
- Double doors are available in any door leaf size combinations. For a double non-rebated door, 'active' and 'passive' door leaves must be ordered.
- Magnetic lock is not available for a double door
- Size, 100' requires third hinge
- PRIME or 3D hinges - packed with a door frame

### EXTRA CHARGES

- size '100'
- ventilation undercut or ventilation sleeves
- PRIME hinges (for dedicated door frames)
- PRIME lock with glossy faceplate (silver or gold)
- gold 3D hinges (extra charge added to a door frame price)
- third 3D hinge - silver, white, black (extra charge added to a door frame price)
- third 3D hinge - gold (extra charge added to a door frame price)
- magnetic lock with stainless steel faceplate
- magnetic lock: white, black (for non-rebated doors)
- hook lock with side pull handles (sliding doors)
- oblong pull handle for sliding doors
- caps for standard hinges
- handle with an escutcheon

(see p. 224)

# Porta Verte PREMIUM, group A and D

03

TOP  
COLLECTIONS



Porta Verte PREMIUM A.4, Scarlet Oak



Porta Verte PREMIUM A.4, Scarlet Oak



model A.0



model A.1



model A.2



model A.3



model A.4



model D.0



model D.1



model D.2



model D.3



model D.5



model D.6



model D.7



model D.8



## AVAILABLE FINISHES

### Portasynchro 3D veneer ★★★★★☆

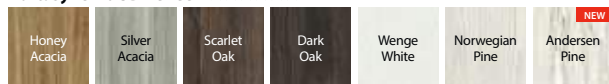

### Portalamino ★★★★★☆



### Premium veneer ★★★★★☆



### Portaperfect 3D veneer ★★★★★☆

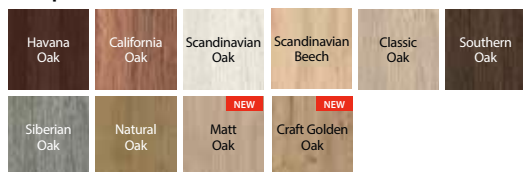

Porta Verte  
PREMIUM



model A.0 - flat panel



model A.0 - frosted glass panel



model D.0 - flat panel



model D.8 - frosted glass panel

## TECHNICAL INFORMATION

### DOOR LEAF CONSTRUCTION

Door leaves contain rails, slim panels and 6 mm thick, frosted, tempered glass. Combination of those depends on a model.

### ACCESSORIES INCLUDED IN THE DOOR LEAF PRICE

- Lock: key lock, WC lock, cylinder lock
- Rebated doors: three standard barrel hinges or PRIME hinges (at extra charge); non-rebated: two 3D hinges
- Frosted tempered glass
- Preparation for shortening (maximum 60 mm)
- Round pull handle (for sliding doors)

### DOOR FRAMES

#### Recommended rebated door frames:

- Porta SYSTEM see p. 200
- MINIMAX see p. 198
- STEEL see p. 212-217

#### Recommended non-rebated door frames:

- Porta SYSTEM ELEGANCE see p. 202
- Porta SYSTEM ELEGANCE 90 degrees, finished with Premium veneer see p. 202
- LEVEL see p. 206

### NOTES

- Norm PN EN 14351-2:2018-12.
- Double doors are available in any door leaf size combinations. For a double non-rebated door, 'active' and 'passive' door leaves must be ordered.
- Magnetic lock is not available for a double door
- Size, 100' requires third hinge
- PRIME or 3D hinges - packed with a door frame

### EXTRA CHARGES

- size '100'
- ventilation undercut or ventilation sleeves
- **OFFER** - PRIME set
- gold 3D hinges (extra charge added to a door frame price)
- third 3D hinge - silver, white, black (extra charge added to a door frame price)
- third 3D hinge - gold (extra charge added to a door frame price)
- magnetic lock with stainless steel faceplate
- magnetic lock: white, black (for non-rebated doors)
- hook lock with side pull handles (sliding doors)
- oblong pull handle for sliding doors
- caps for standard hinges
- handle with an escutcheon

(see p. 224)

# Porta Verte PREMIUM, group B and C

03

TOP  
COLLECTIONS



Porta Verte PREMIUM C.0, Scandinavian Oak



Porta Verte PREMIUM C.0, Scandinavian Oak



model B.0



model B.1



model B.2



model B.3



model C.0



model C.1



model C.2



FRAME AND PANEL



60 - 100



120 - 200



40 mm



## AVAILABLE FINISHES

### Portasynchro 3D veneer ★★★★★☆

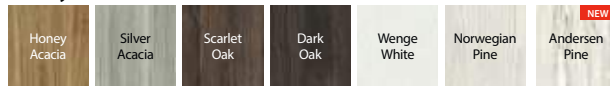

### Portaperfect 3D veneer ★★★★★☆

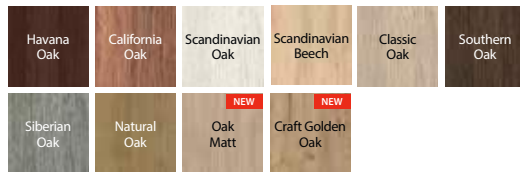

### Portalamino ★★★★★☆



Porta Verte  
PREMIUM



flat panel



frosted glass panel

## TECHNICAL INFORMATION

### DOOR LEAF CONSTRUCTION

Door leaves contain rails, slim panels and 6 mm thick, frosted, tempered glass. Combination of those depends on a model.

### ACCESSORIES INCLUDED IN THE DOOR LEAF PRICE

- Lock: key lock, WC lock, cylinder lock
- Rebated doors: three standard barrel hinges or PRIME hinges (at extra charge); non-rebated: two 3D hinges
- Frosted tempered glass
- Preparation for shortening (maximum 60 mm)
- Round pull handle (for sliding doors)

### DOOR FRAMES

#### Recommended rebated door frames:

- Porta SYSTEM see p. 200
- MINIMAX see p. 198
- STEEL see p. 212-217

#### Recommended non-rebated door frames:

- Porta SYSTEM ELEGANCE see p. 202
- LEVEL see p. 206

### NOTES

- Norm PN EN 14351-2:2018-12.
- Double doors are available in any door leaf size combinations. For a double non-rebated door, 'active' and 'passive' door leaves must be ordered.
- Magnetic lock is not available for a double door
- Size, 100' requires third hinge
- PRIME or 3D hinges - packed with a door frame

### EXTRA CHARGES

- size '100'
- ventilation undercut or ventilation sleeves
- **OFFER** - PRIME set
- gold 3D hinges (extra charge added to a door frame price)
- third 3D hinge - silver, white, black (extra charge added to a door frame price)
- third 3D hinge - gold (extra charge added to a door frame price)
- magnetic lock with stainless steel faceplate
- magnetic lock: white, black (for non-rebated doors)
- hook lock with side pull handles (sliding doors)
- oblong pull handle for sliding doors
- caps for standard hinges
- handle with an escutcheon

(see p. 224)

# Porta Verte PREMIUM, group E

03

TOP  
COLLECTIONS



Porta Verte PREMIUM E.5, White



Porta Verte PREMIUM E.5, White



model E.0



model E.1



model E.2



model E.3



model E.4



model E.5

WE RECOMMEND!

EUPHORIA handle Q with an escutcheon for 0,01 PLN  
- only with Porta Verte PREMIUM group E



EUPHORIA Q handle

+



standard profile  
escutcheon

or



euro profile  
escutcheon

or



WC escutcheon

Special offer terms&conditions: <https://https://www.porta.com.pl/do-pobrania>



## AVAILABLE FINISHES

### Portadecor veneer ★★★★★☆



### Portasynchro 3D veneer ★★★★★☆

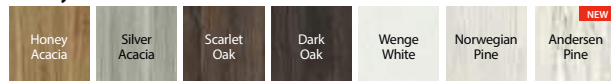

### Premium veneer ★★★★★☆



### Portaperfect 3D veneer ★★★★★☆

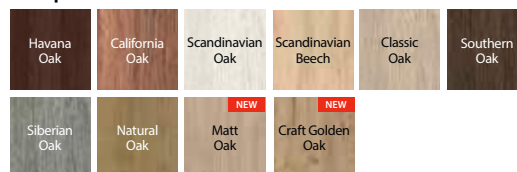

### Portalamino ★★★★★☆

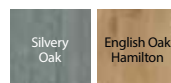

Porta Verte  
PREMIUM



flat panel



frosted glass panel

## TECHNICAL INFORMATION

### DOOR LEAF CONSTRUCTION

Door leaves contain rails, slim panels and 6 mm thick, frosted, tempered glass. Combination of those depends on a model.

### ACCESSORIES INCLUDED IN THE DOOR LEAF PRICE

- Lock: key lock, WC lock, cylinder lock
- Rebated doors: three standard barrel hinges or PRIME hinges (at extra charge); non-rebated: two 3D hinges
- Frosted tempered glass
- Preparation for shortening (maximum 60 mm)
- Round pull handle (for sliding doors)

### DOOR FRAMES

#### Recommended rebated door frames:

- Porta SYSTEM see p. 200
- MINIMAX see p. 198
- STEEL see p. 212-217

#### Recommended non-rebated door frames:

- Porta SYSTEM ELEGANCE see p. 202
- Porta SYSTEM ELEGANCE 90 degrees, finished with Premium veneer see p.174
- LEVEL see p. 206

### NOTES

- Norm PN EN 14351-2:2018-12.
- Double doors are available in any door leaf size combinations. For a double non-rebated door, 'active' and 'passive' door leaves must be ordered
- Magnetic lock is not available for a double door
- Size, 100' requires third hinge
- PRIME or 3D hinges - packed with a door frame

### EXTRA CHARGES

- size '100'
- ventilation undercut or ventilation sleeves
- **OFFER** - PRIME set
- gold 3D hinges (extra charge added to a door frame price)
- third 3D hinge - silver, white, black (extra charge added to a door frame price)
- third 3D hinge - gold (extra charge added to a door frame price)
- magnetic lock with stainless steel faceplate
- magnetic lock: white, black (for non-rebated doors)
- hook lock with side pull handles (sliding doors)
- oblong pull handle for sliding doors
- caps for standard hinges
- handle with an escutcheon

(see p. 224)

# Porta CONCEPT, group A and B

03



Porta CONCEPT A.9, Natural Oak

WE RECOMMEND

Traditional frame and panel construction guarantees long-time durability.



Porta CONCEPT A.9, Natural Oak



model A.0



model A.2



model A.3



model A.4



model A.6



model A.7



model A.8



model A.9



model B.0



model B.1

Check more models from this collection on a website







## AVAILABLE FINISHES

### Portadecor veneer ★★★★★☆

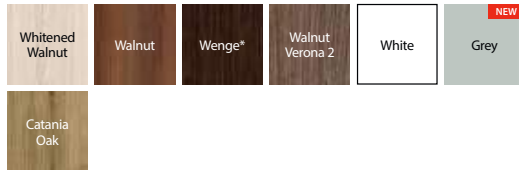

\* until stocks last

### Portasynchro 3D veneer ★★★★★☆

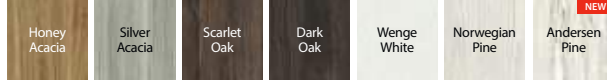

### Premium veneer ★★★★★☆



### Portadur veneer ★★★★★☆



\* until stocks last

### Portaperfect 3D veneer ★★★★★☆

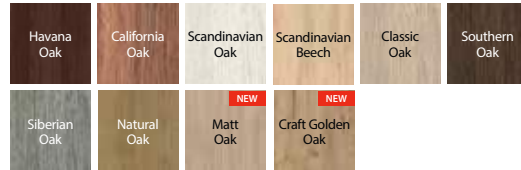

### Portalamino ★★★★★☆

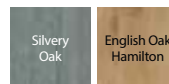

Porta CONCEPT



frosted glass panel



flat panel



adjustment of 3D adjustable barrel hinges

Check how to adjust hinges



### WE RECOMMEND!

Special, multilayer wooden construction.



## TECHNICAL INFORMATION

### DOOR LEAF CONSTRUCTION

Door leaves contain rails, slim panels and 6 mm thick, frosted, tempered glass. Combination of those depends on a model.

### ACCESSORIES INCLUDED IN THE DOOR LEAF PRICE

- Lock: key lock, WC lock, cylinder lock
- Rebated doors: three standard barrel hinges or PRIME hinges (at extra charge); non-rebated: two 3D hinges
- Frosted tempered glass
- Preparation for shortening (maximum 60 mm)
- Round pull handle (for sliding doors)

### DOOR FRAMES

#### Recommended rebated door frames:

- Porta SYSTEM see p. 200
- MINIMAX see p. 198
- STEEL see p. 212-217

#### Recommended non-rebated door frames:

- Porta SYSTEM ELEGANCE see p. 202
- Porta SYSTEM ELEGANCE 90 degrees, finished with Premium veneer see p. 202
- LEVEL see p. 206

### NOTES

- Norm PN EN 14351-2:2018-12.
- Double doors are available in any door leaf size combinations. For a double non-rebated door, 'active' and 'passive' door leaves must be ordered.
- Magnetic lock is not available for a double door
- Size, 100' requires third hinge
- Hinges packed with a door frame

### EXTRA CHARGES

- size '100'
- ventilation undercut or ventilation sleeves
- non-rebated leaves: gold 3D hinges (extra charge added to a door frame price)
- non-rebated leaves: third 3D hinge - silver, white, black (extra charge added to a door frame price)
- third 3D hinge - gold (extra charge added to a door frame price)
- magnetic lock with stainless steel faceplate
- magnetic lock: white, black (for non-rebated doors)
- hook lock with side pull handles (sliding doors)
- oblong pull handle for sliding doors
- rebated door leaves : caps for standard hinges
- handle with an escutcheon

(see p. 224)

# Porta CONCEPT, group C

03



**WE RECOMMEND**

Traditional frame and panel construction guarantees long-time durability.

Porta CONCEPT C.6, White



Porta CONCEPT C.6, White



model C.0



model C.1



model C.2



model C.3



model C.4



model C.5



model C.6



## AVAILABLE FINISHES

### Portadecor veneer ★★☆☆☆☆

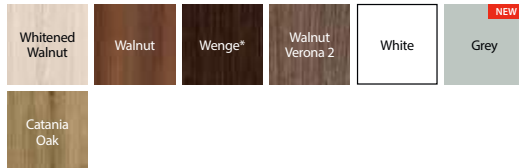

\* until stocks last

### Portasynchro 3D veneer ★★☆☆☆☆

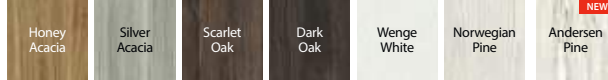

### Premium veneer ★★☆☆☆☆



### Portadur veneer ★★☆☆☆☆

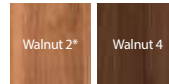

\* until stocks last

### Portaperfect 3D veneer ★★☆☆☆☆

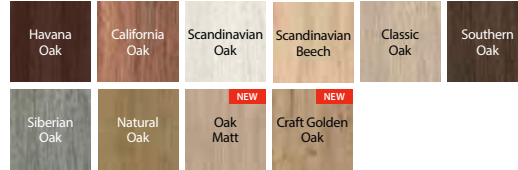

### Portalamino ★★☆☆☆☆

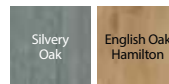

Porta CONCEPT



frosted glass panel



flat panel

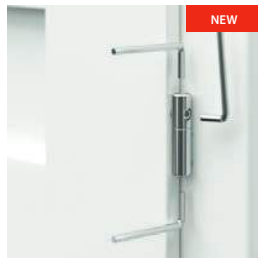

adjustment of 3D adjustable barrel hinges

Check how to adjust hinges



#### WE RECOMMEND!

Special, multilayer wooden construction.



## TECHNICAL INFORMATION

### DOOR LEAF CONSTRUCTION

Door leaves contain rails, slim panels and 6 mm thick, frosted, tempered glass. Combination of those depends on a model.

### ACCESSORIES INCLUDED IN THE DOOR LEAF PRICE

- Lock: key lock, WC lock, cylinder lock
- Rebated doors: three standard barrel hinges or PRIME hinges (at extra charge); non-rebated: two 3D hinges
- Frosted tempered glass
- Preparation for shortening (maximum 60 mm)
- Round pull handle (for sliding doors)

### DOOR FRAMES

#### Recommended rebated door frames:

- Porta SYSTEM see p. 200
- MINIMAX see p. 198
- STEEL see p. 212-217

#### Recommended non-rebated door frames:

- Porta SYSTEM ELEGANCE see p. 202
- Porta SYSTEM ELEGANCE 90 degrees, finished with Premium veneer see p. 202
- LEVEL see p. 206

### NOTES

- Norm PN EN 14351-2:2018-12.
- Double doors are available in any door leaf size combinations. For a double non-rebated door, 'active' and 'passive' door leaves must be ordered.
- Magnetic lock is not available for a double door
- Size, 100' requires third hinge
- Hinges - packed with a door frame

### EXTRA CHARGES

- size '100'
- ventilation undercut or ventilation sleeves
- non-rebated leaves: gold 3D hinges (extra charge added to a door frame price)
- non-rebated leaves: third 3D hinge - silver, white, black (extra charge added to a door frame price)
- third 3D hinge - gold (extra charge added to a door frame price)
- magnetic lock with stainless steel faceplate
- magnetic lock: white, black (for non-rebated doors)
- hook lock with side pull handles (sliding doors)
- oblong pull handle for sliding doors
- rebated door leaves : caps for standard hinges
- handle with an escutcheon

(see p. 224)

# Porta CONCEPT, group H and K

03



Porta CONCEPT K.3, English Oak Hamilton

WE RECOMMEND

Traditional frame and panel construction guarantees long-time durability.



Porta CONCEPT H.4, English Oak Hamilton



model H.0



model H.1



model H.2



model H.4



model K.0



model K.1



model K.2



model K.3



## AVAILABLE FINISHES

### Portadecor veneer ★★☆☆☆☆

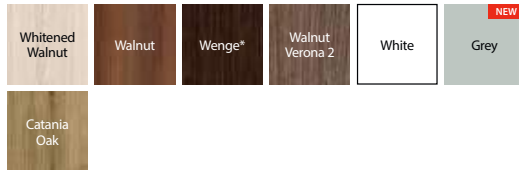

\* until stocks last

### Portasynchro 3D veneer ★★☆☆☆☆

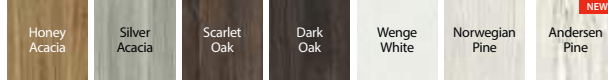

### Premium veneer ★★☆☆☆☆



### Portadur veneer ★★☆☆☆☆

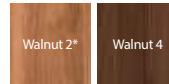

\* until stocks last

### Portaperfect 3D veneer ★★☆☆☆☆

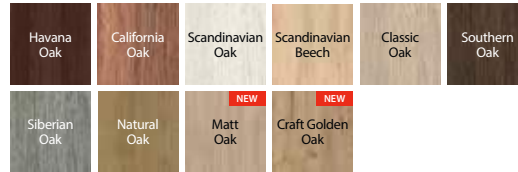

### Portalamino ★★☆☆☆☆

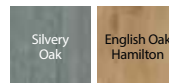

Porta CONCEPT



H.4 model - frosted glass panel



H.0 model - flat panel



K.3 model - frosted glass panel.3

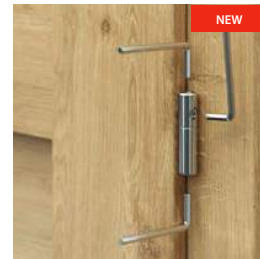

adjustment of 3D adjustable barrel hinges

Check how to adjust hinges



#### WE RECOMMEND!

Special, multilayer wooden construction.



## TECHNICAL INFORMATION

### DOOR LEAF CONSTRUCTION

Door leaves contain rails, slim panels and 6 mm thick, frosted, tempered glass. Combination of those depends on a model.

### ACCESSORIES INCLUDED IN THE DOOR LEAF PRICE

- Lock: key lock, WC lock, cylinder lock
- Rebated doors: three standard barrel hinges or PRIME hinges (at extra charge); non-rebated: two 3D hinges
- Frosted tempered glass
- Preparation for shortening (maximum 60 mm)
- Round pull handle (for sliding doors)

### DOOR FRAMES

#### Recommended rebated door frames:

- Porta SYSTEM see p. 200
- MINIMAX see p. 198
- STEEL see p. 212-217

#### Recommended non-rebated door frames:

- Porta SYSTEM ELEGANCE see p. 202
- Porta SYSTEM ELEGANCE 90 degrees, finished with Premium veneer see p. 202
- LEVEL see p. 206

### NOTES

- Norm PN EN 14351-2:2018-12.
- Double doors are available in any door leaf size combinations. For a double non-rebated door, 'active' and 'passive' door leaves must be ordered.
- Magnetic lock is not available for a double door
- Size, 100' requires third hinge
- Hinges - packed with a door frame

### EXTRA CHARGES

- size '100'
- ventilation undercut or ventilation sleeves
- non-rebated leaves: gold 3D hinges (extra charge added to a door frame price)
- non-rebated leaves: third 3D hinge - silver, white, black (extra charge added to a door frame price)
- third 3D hinge - gold (extra charge added to a door frame price)
- magnetic lock with stainless steel faceplate
- magnetic lock: white, black (for non-rebated doors)
- hook lock with side pull handles (sliding doors)
- oblong pull handle for sliding doors
- rebated door leaves : caps for standard hinges
- handle with an escutcheon

(see p. 224)

# Porta BALANCE

03



Porta BALANCE D.0, D.3, Wenge White



Porta BALANCE D.0, Wenge White



model A.0



model B.0



model B.1



model D.0



model D.1



model D.2



model D.3



## AVAILABLE FINISHES

### Portadecor veneer ★★☆☆☆☆



### Portasynchro 3D veneer ★★☆☆☆☆

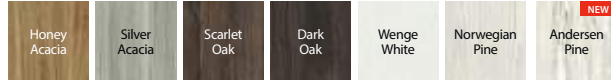

### Portaperfect 3D veneer ★★★★★☆

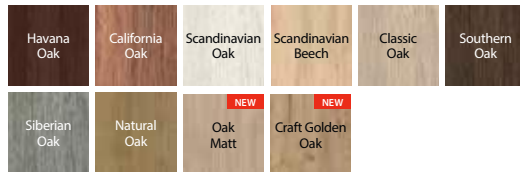

### Portalamino ★★★★★☆



Porta BALANCE



frosted glass panel



raised panel

## TECHNICAL INFORMATION

### DOOR LEAF CONSTRUCTION

Door leaves contain rails and stiles, slim panels and 4 mm thick, frosted, tempered glass. Combination of those depends on a model.

### ACCESSORIES INCLUDED IN THE DOOR LEAF PRICE

- Lock: key lock, WC lock, cylinder lock,
- Rebated doors: three standard barrel hinges or PRIME hinges (at extra charge); non-rebated: two 3D hinges
- Frosted tempered glass
- Preparation for shortening (maximum 30 mm)
- Round pull handle (for sliding doors)

### DOOR FRAMES

#### Recommended rebated door frames:

- Porta SYSTEM see p. 200
- MINIMAX see p. 198
- STEEL see p. 212-217

#### Recommended non-rebated door frames:

- Porta SYSTEM ELEGANCE see p. 202
- LEVEL see p. 206

### NOTES

- Norm PN EN 14351-2:2018-12.
- Double doors are available in any door leaf size combinations. For a double non-rebated door, 'active' and 'passive' door leaves must be ordered.
- Magnetic lock is not available for a double door
- Size, 100' requires third hinge
- PRIME or 3D hinges - packed with a door frame

### EXTRA CHARGES

- size '100'
- ventilation undercut or ventilation sleeves
- PRIME hinges (for dedicated door frames)
- PRIME lock with glossy faceplate (silver or gold)
- gold 3D hinges (extra charge added to a door frame price)
- third 3D hinge - silver, white, black (extra charge added to a door frame price)
- third 3D hinge - gold (extra charge added to a door frame price)
- magnetic lock with stainless steel faceplate
- magnetic lock: white, black (for non-rebated doors)
- hook lock with side pull handles (sliding doors)
- oblong pull handle for sliding doors
- caps for standard hinges
- handle with an escutcheon

(see p. 224)

# Porta HARMONY

03



Porta HARMONY B.0, Siberian Oak



Porta HARMONY B.0, Siberian Oak



model A.0



model A.1



model B.0



model B.1



model B.2



model C.0



model C.1





## AVAILABLE FINISHES

### Portadecor veneer ★★☆☆☆☆



### Portasynchro 3D veneer ★★☆☆☆☆

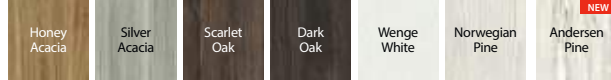

### Portaperfect 3D veneer ★★★★★☆

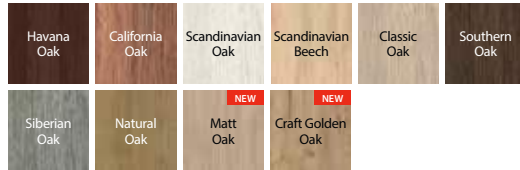

### Portalamino ★★★★★☆



frosted glass panel



raised panel

## TECHNICAL INFORMATION

### DOOR LEAF CONSTRUCTION

Door leaves contain rails and stiles, slim panels and 4 mm thick, frosted, tempered glass. Combination of those depends on a model.

### ACCESSORIES INCLUDED IN THE DOOR LEAF PRICE

- Lock: key lock, WC lock, cylinder lock,
- Rebated doors: three standard barrel hinges or PRIME hinges (at extra charge); non-rebated: two 3D hinges
- Frosted tempered glass
- Round pull handle (for sliding doors)
- Preparation for shortening (maximum 30 mm)

### DOOR FRAMES

#### Recommended rebated door frames:

- Porta SYSTEM see p. 200
- MINIMAX see p. 198
- STEEL see p. 212-217

#### Recommended non-rebated door frames:

- Porta SYSTEM ELEGANCE see p. 202
- LEVEL see p. 206

### NOTES

- Norm PN EN 14351-2:2018-12.
- Double doors are available in any door leaf size combinations. For a double non-rebated door, 'active' and 'passive' door leaves must be ordered.
- Magnetic lock is not available for a double door
- Size, 100' requires third hinge
- PRIME or 3D hinges - packed with a door frame

### EXTRA CHARGES

- size '100'
- ventilation undercut or ventilation sleeves
- PRIME hinges (for dedicated door frames)
- PRIME lock with glossy faceplate (silver or gold)
- gold 3D hinges (extra charge added to a door frame price)
- third 3D hinge - silver, white, black (extra charge added to a door frame price)
- third 3D hinge - gold (extra charge added to a door frame price)
- magnetic lock with stainless steel faceplate
- magnetic lock: white, black (for non-rebated doors)
- hook lock with side pull handles (sliding doors)
- oblong pull handle for sliding doors
- caps for standard hinges
- handle with an escutcheon

(see p. 224)

# Porta INSPIRE, group A and B

03



**WE RECOMMEND**

Traditional frame and panel construction guarantees long-time durability.

Porta INSPIRE A.0, Scandinavian Oak, retro module



Porta INSPIRE A.0, Scandinavian Oak



model A.0



model A.1



model A.1  
with a mirror



model B.0



model B.1



model B.2



model B.3

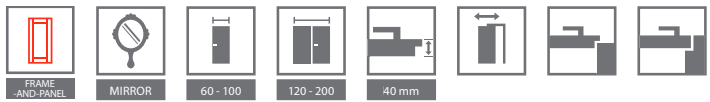

## AVAILABLE FINISHES

### Portadecor veneer ★★☆☆☆☆



### Portalamino ★★★★★☆



### Portasynchro 3D veneer ★★★★★☆

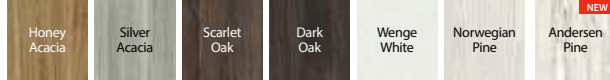

### Portaperfect 3D veneer ★★★★★☆

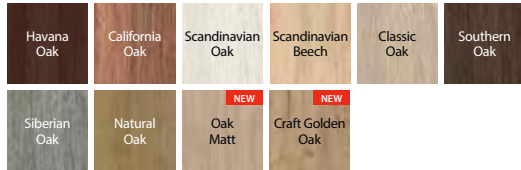

Porta INSPIRE



frosted glass panel, 'frame'



fancy decorative moulding

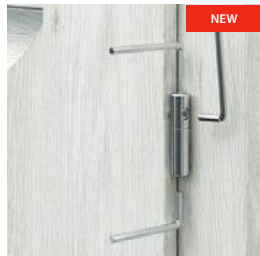

adjustment of 3D adjustable barrel hinges

Check how to adjust hinges



#### WE RECOMMEND!

Special, multilayer wooden construction.



## TECHNICAL INFORMATION

### DOOR LEAF CONSTRUCTION

Door leaves contain rails and stiles, slim panels and 6 mm thick, frosted, tempered glass. Combination of those depends on a model. It is possible to produce model A.1 with mirror on one or on both sides. If a mirror is only on one side, there is a solid board on the other side.

### ACCESSORIES INCLUDED IN THE DOOR LEAF PRICE

- Lock: key lock, WC lock, cylinder lock,
- Rebated doors: three standard barrel hinges or PRIME hinges (at extra charge); non-rebated: two 3D hinges
- Frosted tempered glass and frosted glass
- Preparation for shortening (maximum 60 mm)
- Round pull handle (for sliding doors)

### DOOR FRAMES

#### Recommended rebated door frames:

- Porta SYSTEM see p. 200

#### Recommended non-rebated door frames:

- Porta SYSTEM ELEGANCE see p. 202
- LEVEL see p. 206

### NOTES

- Norm PN EN 14351-2:2018-12.
- For a double non-rebated door, 'active' and 'passive' door leaves must be ordered
- **If a mirror is only on one side, there is a solid board on the other side.**
- Magnetic lock is not available for a double door
- Size, 100' requires third hinge
- Hinges - packed with a door frame

### EXTRA CHARGES

- size '100'
- ventilation undercut or ventilation sleeves
- non-rebated leaves: gold 3D hinges (extra charge added to a door frame price)
- non-rebated leaves: third 3D hinge - silver, white, black (extra charge added to a door frame price)
- non-rebated leaves: third 3D hinge - gold (extra charge added to a door frame price)
- magnetic lock with stainless steel faceplate
- magnetic lock: white, black (for non-rebated doors)
- hook lock with side pull handles (sliding doors)
- oblong pull handle for sliding doors
- rebated leaves: caps for hinges
- mirror on one side
- mirror on both sides
- handle with an escutcheon

(see p. 224)



# Porta INSPIRE, group C

03



Porta INSPIRE C.4, Classic Oak



Porta INSPIRE C.4, Classic Oak



model C.0



model C.1



model C.2



model C.3



model C.4



## AVAILABLE FINISHES

### Portadecor veneer ★★☆☆☆☆



### Portasynchro 3D veneer ★★☆☆☆☆

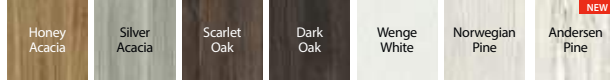

### Premium veneer ★★☆☆☆☆



### Portaperfect 3D veneer ★★☆☆☆☆

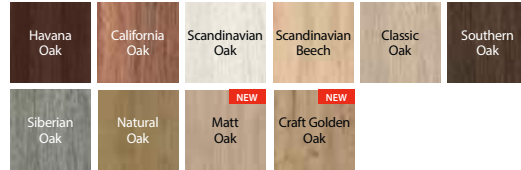

### Portalamino ★★☆☆☆☆



Porta INSPIRE



frosted glass panel



fancy panel

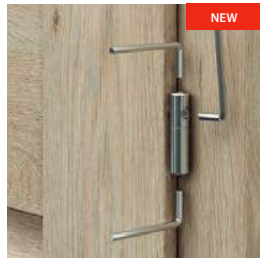

adjustment of 3D adjustable barrel hinges

Check how to adjust hinges



#### WE RECOMMEND!

Special, multilayer wooden construction.



## TECHNICAL INFORMATION

### DOOR LEAF CONSTRUCTION

Door leaves contain rails and stiles, slim panels and 6 mm thick, frosted, tempered glass. Combination of those depends on a model.

### ACCESSORIES INCLUDED IN THE DOOR LEAF PRICE

- Lock: key lock, WC lock, cylinder lock,
- Rebated doors: three standard barrel hinges or PRIME hinges (at extra charge); non-rebated: two 3D hinges
- Frosted tempered glass
- Round pull handle (for sliding doors)
- Preparation for shortening (maximum 60 mm)

### DOOR FRAMES

#### Recommended rebated door frames:

- Porta SYSTEM see p. 200

#### Recommended non-rebated door frames:

- Porta SYSTEM ELEGANCE see p. 202
- Porta SYSTEM ELEGANCE 90 degrees, finished with Premium veneer see p. 202
- LEVEL see p. 206

### NOTES

- Norm PN EN 14351-2:2018-12
- For a double non-rebated door, 'active' and 'passive' door leaves must be ordered.
- Magnetic lock is not available for a double door
- Size, 100' requires third hinge
- PRIME or 3D hinges - packed with a door frame

### EXTRA CHARGES

- size '100'
- ventilation undercut or ventilation sleeves
- non-rebated leaves: gold 3D hinges (extra charge added to a door frame price)
- non-rebated leaves: third 3D hinge - silver, white, black (extra charge added to a door frame price)
- non-rebated leaves: third 3D hinge - gold (extra charge added to a door frame price)
- magnetic lock with stainless steel faceplate
- magnetic lock: white, black (for non-rebated doors)
- hook lock with side pull handles (sliding doors)
- oblong pull handle for sliding doors
- rebated leaves: caps for hinges
- handle with an escutcheon

(see p. 224)

# PORTA GLASS

04



PORTA GLASS, transparent glass with painted muntins



PORTA GLASS, frosted glass



graphite  
glass  
transparent



frosted  
glass



transparent  
glass



frosted  
glass with  
painted muntins



transparent  
glass with  
painted muntins



60-90



black lock



silver lock



black hinge



silver hinge

PORTA GLASS

$$\text{PORTA GLASS (set)} = \text{price of glass pane} + \text{price of door frame} + \text{price per set of fittings}$$

## TECHNICAL INFORMATION

### DOOR LEAF

Glass panel of 8 mm thickness with prepared holes for mounting the lock and hinges.

### ACCESSORIES

- Standard lock (handle only) or adapted for a mortise and tumbler lock in silver or black,
- Two DORMA hinges in silver or black.

### DOOR FRAMES

- PORTA SYSTEM p. 200

### NOTES

- Lock and hinges packed separately.
- Line width in patterns with painted muntins - 30 mm.

### EXTRA CHARGES

- size „90“
- ventilation undercut

# Porta DECOR

04

**TOP**  
COLLECTIONS

Porta DECOR P, Scandinavian Beech

Chosen models with hollow or chipboard core are classified with 3rd strength performance class.

**WE RECOMMEND**

'Investment set' additionally available. It contains 3 part hinges and lock of the highest category of use (at extra charge). The set consists of a door leaf (finished with portalamino veneer) and dedicated door frame.



Porta DECOR P, Scandinavian Beech



model P



model M



model D



model L





## AVAILABLE FINISHES

### Portadecor veneer ★★☆☆☆☆

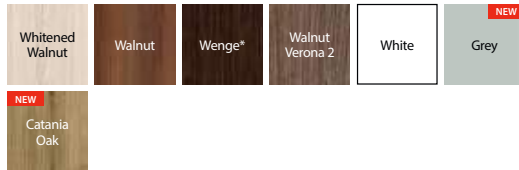

\* until stocks last

### Portasynchro 3D veneer ★★☆☆☆☆

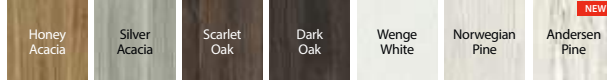

### Portaperfect 3D veneer ★★☆☆☆☆

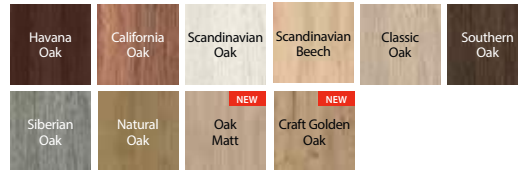

### Portalamino ★★☆☆☆☆

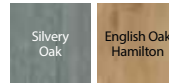

Porta DECOR



glazing bead with a glass panel



'Chinchilla' glass panel

## TECHNICAL INFORMATION

### DOOR LEAF CONSTRUCTION

Honeycomb or hollow chipboard core reinforced with rails and stiles. The construction is skinned with HDF.

### ACCESSORIES INCLUDED IN THE DOOR LEAF PRICE

- Rebated doors: two or three standard barrel hinges or PRIME hinges (optionally at extra charge); non-rebated: two 3D hinges
- Lock: key lock, WC lock, or cylinder lock
- 'Chinchilla' glass or frosted tempered glass (optionally at extra charge)
- Round pull handle (for sliding doors)

### DOOR FRAMES

#### Recommended rebated door frames:

- Porta SYSTEM see p. 200
- MINIMAX see p. 198
- STEEL see p. 212-217

#### Recommended non-rebated door frames:

- Porta SYSTEM ELEGANCE see p. 202
- LEVEL see p. 206

### NOTES

- Norm PN EN 14351-2:2018-12.
- Hollow chipboard core has preparation for shortening as a standard.
- Size '110' is available only with hollow chipboard core. Glazing size is the same as for size '100'.
- Double doors are available in any door leaf size combinations. Passive door leaves (side panel) in sizes '30', '40', '50' available only in flat option (without glazing or decorative applications).
- For a double non-rebated door, 'active' and 'passive' door leaves must be ordered.
- Magnetic lock is not available for a double door.
- **Size '80' and '90' in investment norm (clear opening width 800, 900 mm) available as a standard- without extra charge.**

- Reinforcement for a door closer requires third hinge.
- Sizes '100' and '110' require third hinge.
- Investment set is available only with hollow chipboard core
- Investment set is available with rebated door frames: Porta SYSTEM, Steel Porta SYSTEM, Steel Adjustable, Corner profile - Large and Small
- PRIME or 3D hinges - packed with a door frame

### EXTRA CHARGES

- size '100' and '110'
- hollow chipboard core
- chipboard core
- ventilation grille, ventilation sleeves or ventilation undercut
- inverse glazing
- PRIME hinges (applies to dedicated door frames)
- PRIME lock with glossy faceplate (silver or gold)
- gold 3D hinges (extra charge added to a door frame price)
- third 3D hinge - silver, white, black (extra charge added to a door frame price)
- third 3D hinge - gold (extra charge added to a door frame price)
- magnetic lock with stainless steel faceplate
- magnetic lock: white, black (for non-rebated doors)
- preparation for shortening (maximum 60 mm)
- reinforcement for door closer (third hinge is required)
- stainless steel porthole
- automatic threshold seal
- investment set (extra charge added to a door leaf)
- investment set (extra charge added to a door frame)
- hook lock with side pull handles (sliding doors)
- oblong pull handle for sliding doors
- caps for standard hinges
- frosted tempered glass - model M
- frosted tempered glass - model D
- frosted tempered glass - model L
- handle with an escutcheon

(see p. 224)

# Porta STYL

04



Porta STYL 1, California Oak



Porta STYL 1, California Oak



model 1



model 2



model 3

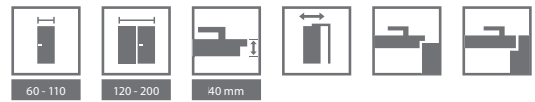

## AVAILABLE FINISHES

### Portadecor veneer ★★☆☆☆☆

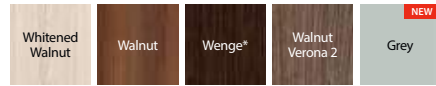

\* until stocks last

### Portasynchro 3D veneer ★★☆☆☆☆

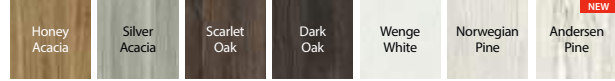

### Portaperfect 3D veneer ★★☆☆☆☆



### CPL HQ 0,2 veneer ★★☆☆☆☆



Porta STYL



glazed model

#### NOTE

If you're looking for a flush door that matches this collection, check Porta DECOR see p. 88 and Porta CPL see p. 104.

## TECHNICAL INFORMATION

### DOOR LEAF CONSTRUCTION

Honeycomb or hollow chipboard core reinforced with rails and stiles (at an extra charge). The construction is skinned with HDF. There is lipping ABS on the side edges of the doors finished with CPL.

### ACCESSORIES INCLUDED IN THE DOOR LEAF PRICE

- Rebated doors: two or three standard barrel hinges or PRIME hinges (optionally at extra charge); non-rebated: two 3D hinges
- Lock: key lock, WC lock, or cylinder lock
- 'Chinchilla' glass or frosted tempered glass
- Round pull handle (for sliding doors)

### DOOR FRAMES

#### Recommended rebated door frames:

- Porta SYSTEM see p. 200
- MINIMAX see p. 198
- STEEL see p. 212-217

#### Recommended non-rebated door frames:

- Porta SYSTEM ELEGANCE see p. 202
- LEVEL see p. 206

### NOTES

- Norm PN EN 14351-2:2018-12.
- Hollow chipboard core has preparation for shortening as a standard.
- Size '110' is available only with hollow chipboard core. Glazing size is the same as for size '100'.
- Double doors are available in any door leaf size combinations. For a double non-rebated door, 'active' and 'passive' door leaves must be ordered.

- Magnetic lock is not available for a double door.
- Reinforcement for a door closer requires third hinge.
- Sizes, 100' and, 110' require third hinge.
- PRIME or 3D hinges - packed with a door frame

### EXTRA CHARGES

- size '100' and '110'
- hollow chipboard core
- chipboard core
- inverse glazing
- CPL 0,2 mm finish - GROUP II
- ventilation grille, ventilation sleeves or ventilation undercut
- PRIME hinges (applies to dedicated door frames)
- PRIME lock with glossy faceplate (silver or gold)
- gold 3D hinges (extra charge added to a door frame price)
- third 3D hinge - silver, white, black (extra charge added to a door frame price)
- third 3D hinge - gold (extra charge added to a door frame price)
- magnetic lock with stainless steel faceplate
- magnetic lock: white, black (for non-rebated doors)
- OFFER - doors with CPL finish- PRIME set
- automatic threshold seal
- preparation for shortening (maximum 60 mm)
- reinforcement for door closer (third hinge is required)
- hook lock with side pull handles (sliding doors)
- oblong pull handle for sliding doors
- caps for standard hinges
- handle with an escutcheon

(see p. 224)

# Porta FIT, group C, I

04



Porta FIT I.1, Matt Oak



Porta FIT I.1, Matt Oak



model C.0



model C.1



model C.3



model I.0



model I.1

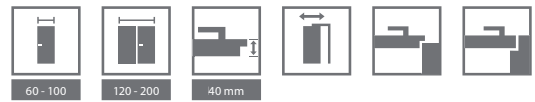

## AVAILABLE FINISHES

### Portadecor veneer ★★☆☆☆☆

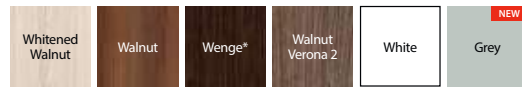

\* until stocks last

### Portasynchro 3D veneer ★★☆☆☆☆

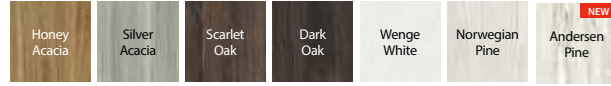

### Portaperfect 3D veneer ★★☆☆☆☆

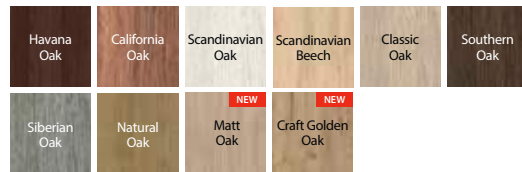

### CPL HQ 0,2 veneer ★★☆☆☆☆



Porta FIT



glazing bead with glass panels  
NOTE: in case of CPL finish the glazing bead is rounded



glazing bead with a slim panel  
NOTE: in case of CPL finish the glazing bead is rounded

#### NOTE

If you're looking for a flush door that matches this collection, check Porta DECOR see p. 88 and Porta CPL see p. 104.

## TECHNICAL INFORMATION

### DOOR LEAF CONSTRUCTION

Models A, B, C and I honeycomb and stabilising insert or chipboard core (at an extra charge). The construction is reinforced with rails and stiles and skinned with HDF. There is lipping ABS on the side edges of the doors finished with CPL.

### ACCESSORIES INCLUDED IN THE DOOR LEAF PRICE

- Rebated doors: two or three standard barrel hinges or PRIME hinges (optionally at extra charge); non-rebated: two 3D hinges
- Lock: key lock, WC lock, or cylinder lock
- 'Chinchilla' glass or frosted tempered glass
- Round pull handle (for sliding doors)

### DOOR FRAMES

#### Recommended rebated door frames:

- Porta SYSTEM see p. 200
- MINIMAX see p. 198
- STEEL see p. 212-217

#### Recommended non-rebated door frames:

- Porta SYSTEM ELEGANCE see p. 202
- LEVEL see p. 206

### NOTES

- Norm PN EN 14351-2:2018-12.
- Double doors are available in any door leaf size combinations. For a double non-rebated door, 'active' and 'passive' door leaves must be ordered.
- Magnetic lock is not available for a double door.
- Reinforcement for a door closer requires third hinge.
- Size, 100' requires third hinge.
- PRIME or 3D hinges - packed with a door frame

### EXTRA CHARGES

- size '100'
- hollow chipboard core or chipboard core
- inverse glazing
- CPL 0,2 mm finish - GROUP II
- ventilation grille, ventilation sleeves or ventilation undercut
- PRIME hinges (applies to dedicated door frames)
- PRIME lock with glossy faceplate (silver or gold)
- gold 3D hinges (extra charge added to a door frame price)
- third 3D hinge - silver, white, black (extra charge added to a door frame price)
- third 3D hinge - gold (extra charge added to a door frame price)
- magnetic lock with stainless steel faceplate
- magnetic lock: white, black (for non-rebated doors)
- OFFER - doors with CPL finish- PRIME set
- automatic threshold seal
- preparation for shortening (maximum 60 mm)
- reinforcement for door closer (third hinge is required)
- hook lock with side pull handles (sliding doors)
- oblong pull handle for sliding doors
- caps for standard hinges
- handle with an escutcheon

(see p. 224)

# Porta FIT, group F-H

04



Porta FIT G.5, Norwegian Pine



Porta FIT G.5, Norwegian Pine



model F.2



model F.6



model G.0



model G.2



model G.3



model G.5



model H.0



model H.1



model H.3



model H.4

Check more models from this collection on a website



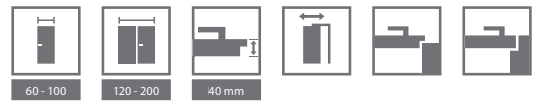

## AVAILABLE FINISHES

### Portadecor veneer ★★☆☆☆☆

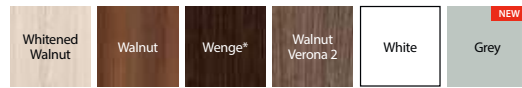

\* until stocks last

### Portasynchro 3D veneer ★★☆☆☆☆

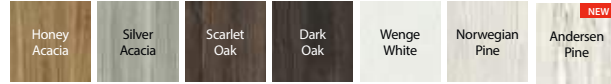

### Portaperfect 3D veneer ★★☆☆☆☆

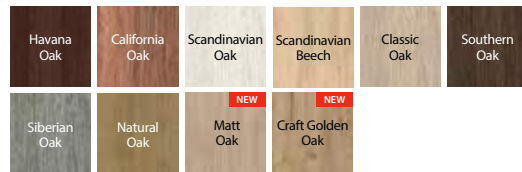

### CPL HQ 0,2 veneer ★★☆☆☆☆



Porta FIT



glazing bead with a glass panel  
NOTE: in case of CPL finish the glazing bead is rounded



glazing bead with a glass panel  
NOTE: in case of CPL finish the glazing bead is rounded

#### NOTE

If you're looking for a flush door that matches this collection, check Porta DECOR see p. 88 and Porta CPL see p. 104.

## TECHNICAL INFORMATION

### DOOR LEAF CONSTRUCTION

Honeycomb and stabilising insert or chipboard core (at an extra charge). The construction is reinforced with rails and stiles and skinned with HDF. There is lipping ABS on the side edges of the doors finished with CPL.

### ACCESSORIES INCLUDED IN THE DOOR LEAF PRICE

- Rebated doors: two or three standard barrel hinges or PRIME hinges (optionally at extra charge); non-rebated: two 3D hinges
- Lock: key lock, WC lock, or cylinder lock
- 'Chinchilla' glass or frosted tempered glass
- Round pull handle (for sliding doors)

### DOOR FRAMES

#### Recommended rebated door frames:

- Porta SYSTEM see p. 200
- MINIMAX see p. 198
- STEEL see p. 212-217

#### Recommended non-rebated door frames:

- Porta SYSTEM ELEGANCE see p. 202
- LEVEL see p. 206

### NOTES

- Norm PN EN 14351-2:2018-12.
- Ventilation grille and 2 rows of ventilation sleeves are not available for model H
- Double doors are available in any door leaf size combinations. For a double non-rebated door, 'active' and 'passive' door leaves must be ordered. Magnetic lock is not available for a double door.

- Reinforcement for a door closer requires third hinge.
- Size, 100' requires third hinge.
- PRIME or 3D hinges - packed with a door frame

### EXTRA CHARGES

- size '100'
- hollow chipboard core or chipboard core
- inverse glazing
- CPL 0,2 mm finish - GROUP II
- ventilation grille, ventilation sleeves or ventilation undercut
- PRIME hinges (applies to dedicated door frames)
- PRIME lock with glossy faceplate (silver or gold)
- gold 3D hinges (extra charge added to a door frame price)
- third 3D hinge - silver, white, black (extra charge added to a door frame price)
- third 3D hinge - gold (extra charge added to a door frame price)
- magnetic lock with stainless steel faceplate
- magnetic lock: white, black (for non-rebated doors)
- automatic threshold seal
- OFFER - doors with CPL finish- PRIME set
- preparation for shortening (maximum 60 mm)
- reinforcement for door closer (third hinge is required)
- hook lock with side pull handles (sliding doors)
- oblong pull handle for sliding doors
- caps for standard hinges
- handle with an escutcheon

(see p. 224)

# Porta NOVA, group 2-5

04



Porta NOVA 2.1, Silvery Oak



Porta NOVA 5.5, Silvery Oak



model 2.1



model 2.2



model 2.2  
with a mirror



model 3.1



model 3.2



model 4.1



model 4.2



model 4.4



model 5.1



model 5.2



model 5.4



model 5.5

Check more models  
from this collection  
on a website







## AVAILABLE FINISHES

### Portadecor veneer ★★★★★☆



\* until stocks last

### Portasynchro 3D veneer ★★★★★☆

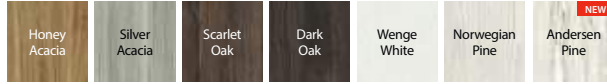

### Portadur veneer ★★★★★☆

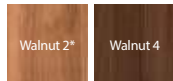

\* until stocks last

### Portaperfect 3D veneer ★★★★★☆

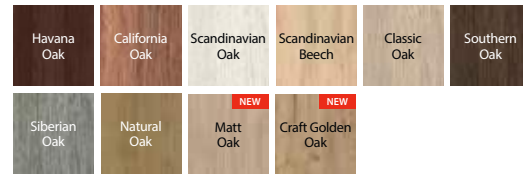

### Portalamino ★★★★★☆



Porta NOVA



decorative moulding with a slim panel

## TECHNICAL INFORMATION

### DOOR LEAF CONSTRUCTION

Chipboard core reinforced with rails and stiles. The construction is skinned with HDF. It is possible to produce model 2.2 with a mirror on one or on both sides. If the mirror is only on one side, there will be slim panel on the other side.

### ACCESSORIES INCLUDED IN THE DOOR LEAF PRICE

- Lock: key lock, WC lock, or cylinder lock
- Rebated doors: two or three standard barrel hinges or PRIME hinges (optionally at extra charge); non-rebated: two 3D hinges
- Glazing - 'chinchilla' glass or frosted tempered glass (at an extra charge)
- Preparation for shortening - maximum 60 mm (group 2 and 3 only)
- Round pull handle (for sliding doors)

### DOOR FRAMES

#### Recommended rebated door frames:

- Porta SYSTEM see p. 200
- MINIMAX see p. 198
- STEEL see p. 212-217

#### Recommended non-rebated door frames:

- Porta SYSTEM ELEGANCE see p. 202
- LEVEL see p. 206

### NOTES

- Norm PN EN 14351-2:2018-12.
- Double doors are available in any door leaf size combinations. For a double non-rebated door, 'active' and 'passive' door leaves must be ordered.
- Magnetic lock is not available for a double door.

- Model 2.2 is not available in size, 100'
- Reinforcement for a door closer requires third hinge.
- Size, 100' requires third hinge.
- PRIME or 3D hinges - packed with a door frame

### EXTRA CHARGES

- size '100'
- frosted glass, model 2.2
- frosted glass, model 3.2
- frosted glass, models from group 4 and 5 (1 PCs of a glass panel)
- ventilation sleeves (1 row) or ventilation undercut
- PRIME hinges (applies to dedicated door frames)
- PRIME lock with glossy faceplate (silver or gold)
- gold 3D hinges (extra charge added to a door frame price)
- third 3D hinge - silver (extra charge added to a door frame price)
- third 3D hinge - gold (extra charge added to a door frame price)
- reinforcement for door closer (third hinge is required)
- automatic threshold seal
- magnetic lock with stainless steel faceplate
- magnetic lock: white, black (for non-rebated doors)
- hook lock with side pull handles (sliding doors)
- oblong pull handle for sliding doors
- caps for standard hinges
- a mirror on one side
- a mirror on both sides
- inverse glazing
- handle with an escutcheon

(see p. 224)

# Porta NOVA, group 6 and 7

04



Porta NOVA 7.1, Honey Acacia, retro module



Porta NOVA 6.3 Honey Acacia, retro module



model 6.1



model 6.2



model 6.3



model 6.4



model 6.5



model 7.1



model 7.2



model 7.5

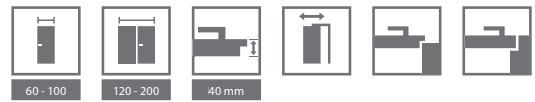

## AVAILABLE FINISHES

### Portadecor veneer ★★☆☆☆☆

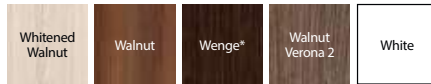

\* until stocks last

### Portasynchro 3D veneer ★★☆☆☆☆

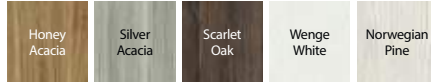

### Portadur veneer ★★☆☆☆☆

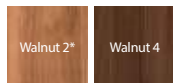

\* until stocks last

### Portaperfect 3D veneer ★★☆☆☆☆

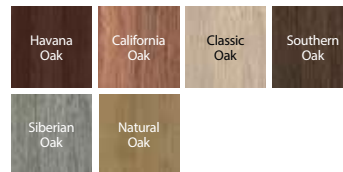

glazing bead with a glass panel



glazing bead with a raised panel

## TECHNICAL INFORMATION

### DOOR LEAF CONSTRUCTION

Chipboard core reinforced with rails and stiles. The construction is skinned with HDF.

### ACCESSORIES INCLUDED IN THE DOOR LEAF PRICE

- Lock: key lock, WC lock, or cylinder lock
- Rebated doors: two or three standard barrel hinges or PRIME hinges (optionally at extra charge); non-rebated: two 3D hinges
- Glazing - 'chinchilla' glass or frosted glass (at an extra charge)
- Preparation for shortening - maximum 60 mm
- Round pull handle (for sliding doors)

### DOOR FRAMES

#### Recommended rebated door frames:

- Porta SYSTEM see p. 200
- MINIMAX see p. 198
- STEEL see p. 212-217

#### Recommended non-rebated door frames:

- Porta SYSTEM ELEGANCE see p. 202
- LEVEL see p. 206

### NOTES

- Norm PN EN 14351-2:2018-12.
- Ventilation grille and 2 rows of ventilation sleeves are available only for models 6.5, 7.5
- Double doors are available in any door leaf size combinations.  
For a double non-rebated door, 'active' and 'passive' door leaves must be ordered.
- Magnetic lock is not available for a double door.
- Reinforcement for a door closer requires third hinge.
- Due to various materials use, there might be a slight colour difference between door leaf and a glazing bead/muntins
- Size, 100' requires third hinge.
- PRIME or 3D hinges - packed with a door frame

### EXTRA CHARGES

- size '100'
- ventilation grille, ventilation sleeves or ventilation undercut
- PRIME hinges (applies to dedicated door frames)
- PRIME lock with glossy faceplate (silver or gold)
- gold 3D hinges (extra charge added to a door frame price)
- third 3D hinge - silver (extra charge added to a door frame price)
- third 3D hinge - gold, white, black (extra charge added to a door frame price)
- automatic threshold seal
- reinforcement for door closer (third hinge is required)
- magnetic lock with stainless steel faceplate
- magnetic lock: white, black (for non-rebated doors)
- hook lock with side pull handles (sliding doors)
- oblong pull handle for sliding doors
- caps for standard hinges
- frosted tempered glass
- handle with an escutcheon

(see p. 224)

# Porta LEVEL

04



Porta LEVEL C.2, Catania Oak. Dedicated door frame LEVEL with top panel 100 cm.

**WE RECOMMEND**

Thanks to new attractive finishes and dedicated door frame LEVEL with 20 cm or 100 cm panel, Porta LEVEL collection gives opportunities for extraordinary interior designs.



Porta LEVEL C.2 with a decorative inlay, Catania Oak  
Door frame with the top panel - 20 cm.



Porta Decor  
model P  
see page 88



model C.1  
Door frame with  
top panel 20 cm



model C.2  
with a decorative  
inlay  
Door frame with  
the top panel  
- 20 cm.



model C.3  
with a decorative  
inlay  
Door frame with  
the top panel  
- 20 cm.

**WE RECOMMEND!**

RUMBA black handle with an escutcheon for 0,01 PLN  
- only with Porta Level collection\*.



RUMBA handle

standard profile  
escutcheon

euro profile  
escutcheon

WC escutcheon

Special offer terms&conditions: <https://www.porta.com.pl/do-pobrania>



## AVAILABLE FINISHES

### Portadecor veneer ★★☆☆☆☆



### Portaperfect 3D veneer ★★★★★☆



### Portalamino ★★★★★☆



#### NOTE

If you're looking for a flush door that matches this collection, check Porta DECOR see page 88.

We offer dedicated door frame LEVEL for Level door leaves. The top panel Level is available with two graining directions – horizontal or vertical - applies to 6 chosen finishes.

Porta LEVEL



dedicated door frame LEVEL



black decorative inlays



silver decorative inlays

## TECHNICAL INFORMATION

### DOOR LEAF CONSTRUCTION

Honeycomb or hollow chipboard core reinforced with rails and stiles. The construction is skinned with HDF.

### ACCESSORIES INCLUDED IN THE DOOR LEAF PRICE

- Rebated doors: two or three standard barrel hinges or PRIME hinges (optionally at extra charge); non-rebated: two 3D hinges
- Lock: key lock, WC lock, or cylinder lock

### DOOR FRAMES

#### Recommended rebated door frames:

- Porta SYSTEM see p. 200
- MINIMAX see p. 198
- STEEL see p. 212-217

#### Recommended non-rebated door frames:

- Porta SYSTEM ELEGANCE see p. 202
- LEVEL see p. 206

### NOTES

- Norm PN EN 14351-2:2018-12.
- Hollow chipboard core and chipboard core have a preparation for shortening as a standard.

- Double doors are available in any door leaf size combinations.
- Magnetic lock is not available for a double door.
- Reinforcement for a door closer requires third hinge.
- Size, 100' requires third hinge.
- PRIME or 3D hinges - packed with a door frame

### EXTRA CHARGES

- size '100'
- hollow chipboard core
- chipboard core
- ventilation sleeves or ventilation undercut
- PRIME hinges (for dedicated door frames)
- PRIME lock with glossy faceplate (silver or gold)
- gold 3D hinges (extra charge added to door frame price)
- third 3D hinge - silver, white, black (extra charge added to door frame price)
- third 3D hinge - gold (extra charge added to door frame price)
- magnetic lock with stainless steel faceplate
- magnetic lock: white, black (for non-rebated doors)
- automatic threshold seal
- preparation for shortening (maximum 60 mm)
- reinforcement for door closer (third hinge is required)
- caps for standard hinges
- handle with an escutcheon

(see p. 224)

# Porta LINE

04

TOP  
COLLECTIONS



Porta LINE G.1, Dark Concrete

Chosen models with hollow or chipboard core are classified with 3rd strength performance class.

**WE RECOMMEND**

'Investment set' additionally available. It contains 3 part hinges and lock of the highest category of use (at extra charge). The set consists of a door leaf (finished with portalamino veneer) and dedicated door frame.



Porta LINE H.1, Dark Concrete



model A.1



model B.1



model C.1



model E.1



model F.1



model G.1



model H.1





## AVAILABLE FINISHES

### Portadecor veneer ★★☆☆☆☆

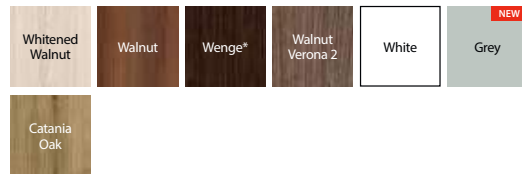

\* until stocks last

### Portasynchro 3D veneer ★★☆☆☆☆

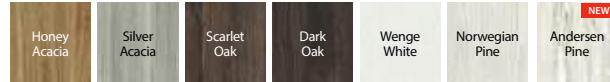

### Portaperfect 3D veneer ★★☆☆☆☆

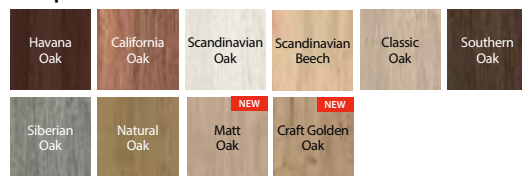

### CPL HQ 0,2 veneer ★★☆☆☆☆



### Portalamino ★★☆☆☆☆



Porta LINE



silver decorative inlays, black and golden are also available

## TECHNICAL INFORMATION

### DOOR LEAF CONSTRUCTION

Honeycomb or hollow chipboard core reinforced with rails and stiles. Then construction is skinned with HDF. Door leaves are enriched with silver or black decorative inlays, 6 mm wide. There is lipping ABS on the side edges of the doors finished with CPL.

### ACCESSORIES INCLUDED IN THE DOOR LEAF PRICE

- Rebated doors: two or three standard barrel hinges or PRIME hinges (optionally at extra charge); non-rebated: two 3D hinges
- Lock: key lock, WC lock, or cylinder lock
- Round pull handle (for sliding doors)

### DOOR FRAMES

#### Recommended rebated door frames:

- Porta SYSTEM see p. 200
- MINIMAX see p. 198
- STEEL see p. 212-217

#### Recommended non-rebated door frames:

- Porta SYSTEM ELEGANCE see p. 202
- LEVEL see p. 206

### NOTES

- Norm PN EN 14351-2:2018-12.
- Ventilation sleeves are not available for D.1 model
- Sliding option of models F.1 and G.1 - decorative inlays placed on pull handle height
- Preparation for shortening is extra charged in case of ordering honeycomb core
- Hollow chipboard core and chipboard core have a preparation for shortening as a standard
- Size '110' is available only with chipboard.
- Double doors are available in any door leaf size combinations.  
For a double non-rebated door, 'active' and 'passive' door leaves must be ordered.
- Magnetic lock is not available for a double door.

- Reinforcement for a door closer requires third hinge.
- Sizes, '100' and '110' require third hinge.
- Investment set is available only with hollow chipboard core or chipboard core
- Investment set is available with a rebated door frame: Porta SYSTEM, Steel Porta SYSTEM, Steel adjustable, Corner profile - SMALL and LARGE
- PRIME or 3D hinges - packed with a door frame
- **Thanks to TechnoPORTA AQUA STOP technology door leaves finished with CPL HQ have lower edges protected against humidity.**

### EXTRA CHARGES

- size '100' and '110'
- hollow chipboard core
- chipboard core
- CPL 0,2 mm finish - GROUP II
- investment set (extra charge added to a door leaf)
- investment set (extra charge added to a door frame)
- ventilation sleeves or ventilation undercut
- PRIME hinges (applies to dedicated door frames)
- PRIME lock with glossy faceplate (silver or gold)
- gold 3D hinges (extra charge added to a door frame price)
- third 3D hinge - silver, white, black (extra charge added to a door frame price)
- third 3D hinge - gold (extra charge added to a door frame price)
- automatic threshold seal
- magnetic lock with stainless steel faceplate
- magnetic lock: white, black (for non-rebated doors)
- OFFER - doors with CPL finish- PRIME set
- preparation for shortening (maximum 60 mm)
- reinforcement for door closer (third hinge is required)
- hook lock with side pull handles (sliding doors)
- an oblong pull handle for sliding doors
- caps for standard hinges
- a handle with an escutcheon

(see p. 224)



# Porta CPL

04

TOP  
COLLECTIONS



Chosen models with hollow or chipboard core are classified with 3rd strength performance class

**WE RECOMMEND**

'Investment set' additionally available. It contains 3 part hinges and lock of the highest category of use (at extra charge). The set consists of a door leaf (finished with portalamino veneer) and dedicated door frame.

Porta CPL 1.1, door leaf - Natural Oak, door frame - Dark concrete



Porta CPL 1.1, Natural Oak



model 1.1



model 1.2



model 1.3



model 1.4



model 1.5



model 5.1



model 5.2



model 5.4



model 5.5



AVAILABLE FINISHES

**CPL HQ 0,2 veneer** ★★★★★☆

**HPL, CPL 0,7 veneer** ★★★★★★



Check the possibilities of ordering bespoke door models through Porta CONTRACT, see page 261.

Group I	White	Grey Euroinvest	Anthracite HPL/CPL	Whitened Walnut	Oak Milano 1	Sand Beech
	Natural Oak	Natural Walnut (matt)	Orzech Modena 1	Oak Milano 4	Oak Milano 5	Craft Golden Oak <b>NEW</b>
Group II	Natural Hickory	Light Concrete	Dark Concrete	Dark structure	Black	

Porta CPL



glazing bead with a glass panel



a glazing bead with a raised panel

TECHNICAL INFORMATION

**DOOR LEAF CONSTRUCTION**

Group 1 - honeycomb, hollow chipboard core or chipboard (at extra charge) reinforced with rails and stiles. Group 5 and model 1.4 - chipboard core. The construction is skinned with HDF. lipping ABS on the side edges.

**ACCESSORIES INCLUDED IN THE DOOR LEAF PRICE**

- Lock: key lock, WC lock, or cylinder lock
- Rebated doors: two or three standard barrel hinges or PRIME hinges; non-rebated: two 3D hinges
- Glazing - 'chinchilla' glass or frosted/transparent tempered glass (optionally at an extra charge)
- Preparation for shortening - max. 60 mm (only group 5)
- Round pull handle (for sliding doors)

**DOOR FRAMES**

**Recommended rebated door frames:**

- Porta SYSTEM see p. 200
- MINIMAX see p. 198
- STEEL see p. 212-217

**Recommended non-rebated door frames:**

- Porta SYSTEM ELEGANCE see p. 202

**NOTES**

- Norm PN EN 14351-2:2018-12.
- Hollow chipboard core and chipboard core have preparation for shortening as a standard.
- Size '110' is available only with hollow chipboard. Glazing size is the same as for size '100'.
- Size '100' and '110' is not available for model 1.4.
- Black finish is not available for models of group 5
- Double doors are available in any door leaf size combinations.
- Passive door leaf (standard) is available for sizes from '60' to '100'.
- Passive door leaf (side panel) - sizes '30', '40', '50' is available only in flat option (without glazing or decorative mouldings). For non-rebated double door 'active' and 'passive' door leaves must be ordered.
- Possibilities of ordering bespoke door models through Porta CONTRACT p. 226.
- Magnetic lock is not available for a double door.
- Size '80' and '90' in investment norm (clear opening width 800, 900 mm) available as a standard- without extra charge.
- Reinforcement for a door closer requires third hinge.

- All of the stainless steel panels are available only for sizes: 80, 90, 100, for doors with hollow chipboard core or chipboard core
- Investment set is available only with hollow or chipboard core
- Investment set is available with a rebated door frame: Porta SYSTEM, Steel Porta SYSTEM, Steel adjustable, Corner profile - SMALL and LARGE
- Sizes, 100' and, 110' require third hinge
- PRIME or 3D hinges - packed with a door frame
- **Thanks to TechnoPORTA AQUA STOP technology door leaves finished with CPL HQ have lower edges protected against humidity.**

**EXTRA CHARGES**

- size '100' and '110'
- hollow chipboard core
- chipboard core
- inverse glazing
- stainless steel porthole - model.
- CPL finish 0,2 and 0,7 mm - GROUP II
- investment set (extra charge added to a door leaf)
- investment set (extra charge added to a door frame)
- OFFER - PRIME set
- gold 3D hinges (extra charge added to door frame price)
- third 3D hinge - silver, white, black (extra charge added to door frame price)
- third 3D hinge - gold (extra charge added to door frame price)
- ventilation grille (only group 1), ventilation sleeves or ventilation undercut
- magnetic lock with stainless steel faceplate
- magnetic lock: white, black (for non-rebated doors)
- preparation for shortening (maximum 60 mm) (group 1)
- reinforcement for door closer (third hinge is required)
- frosted/transparent glass - model 1.2
- frosted/transparent glass - model 1.3 and 1.4
- frosted/transparent glass - model 1.5
- frosted glass - models of group 5 (1PCs of glass)
- stainless steel porthole (model 1.1)
- push panel - both sides set (models 1.1, 1.2)
- kick panel both sides set (models 1.1, 1.2, 1.3)
- kick panel with a ventilation undercut - both sides set (models 1.1, 1.2, 1.3)
- ventilation kick panel - both sides set (models 1.1, 1.2, 1.3)
- hook lock with side pull handles (sliding doors)
- oblong pull handle for sliding doors
- automatic threshold seal
- caps for standard hinges
- handle with an escutcheon

(see p. 224)

# Investment set

04

TOP  
COLLECTIONS



Porta CPL 1.1, Black

## WE RECOMMEND

Investment set contains 3 part hinges and a lock of the highest category of use. The set consists of a door leaf and a dedicated door frame.



Porta CPL 1.1, Black

Investment set is available in closed door models with hollow chipboard core:

- Porta CPL,
- Porta RESIST,
- Porta LINE (finish: CPL, Portalamino),
- Porta DECOR (finish Portalamino),
- Nature CLASSIC.

Investment set is available with a rebated door frame:  
Porta SYSTEM, Steel Porta SYSTEM, Steel Adjustable, Corner profile SMALL PLUS and LARGE.



3 part hinges for Porta SYSTEM door frame - technical placement



3 part hinges for a steel door frame - technical placement



lock of the highest 3rd category of use according to PN-EN 12209

## THE MOST POPULAR MODELS



model 1.1



model 1.2



model 1.5



## AVAILABLE FINISHES Porta CPL

**CPL HQ 0,2 veneer** ★★★★★☆

**HPL, CPL 0,7 veneer** ★★★★★★

GROUP I	White	Grey Euroinvest	Anthracite HPL/CPL	Whitened Walnut	Oak Milano 1	Sand Beech
	Natural Oak	Natural Walnut (matt)	Orzech Modena 1	Oak Milano 4	Oak Milano 5	Craft Golden Oak <b>NEW</b>
GROUP II	Natural Hickory	Light Concrete	Dark Concrete	Dark structure	Black	



Check the possibilities of ordering bespoke door models through Porta CONTRACT, see page 261.

INVESTMENT SET



automatic threshold seal

**NOTE!** The door leaf price includes hollow chipboard core and investment set. Set consists of a door leaf and a dedicated door frame.



push panel



ventilation kick panel

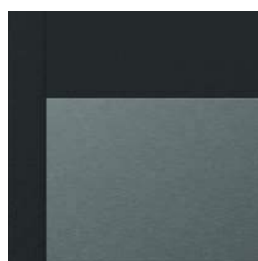

kick panel

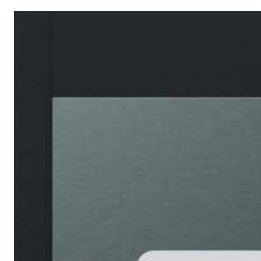

kick panel with ventilation undercut

## TECHNICAL INFORMATION Porta CPL

### DOOR LEAF CONSTRUCTION

Hollow chipboard core or chipboard reinforced with rails and stiles. The construction is skinned with HDF, lipping ABS on the side edges.

### ACCESSORIES INCLUDED IN THE DOOR LEAF PRICE

- Lock: key lock, WC lock, or cylinder lock
- Rebated doors: two or three 3 part hinges
- Glazing - 'chinchilla' glass or frosted/transparent tempered glass (optionally at extra charge)
- Preparation for shortening - max. 60 mm

### DOOR FRAMES

#### Recommended rebated door frames:

- Porta SYSTEM see p. 200
- STEEL see p. 212-217

### NOTES

- Norma PN EN 14351-2:2018-12.
- Hollow chipboard core and chipboard core have preparation for shortening as a standard.
- Glazing size for size '110' is the same as for size '100'.
- Double doors are available in any door leaf size combinations.
- Passive door leaf (standard) is available for sizes from '60' to '100'.
- Passive door leaf (side panel) - sizes '30', '40', '50' is available only in flat option (without glazing or decorative mouldings).
- **Door leaf with Porta SYSTEM of a steel door frame - technical placement of hinges**

- Size '80' and '90' in investment norm (clear opening width 800, 900 mm) available as a standard - without extra charge.
- All of the stainless steel panels are available only for sizes: 80, 90, 100, for doors with hollow chipboard core or chipboard core
- **Thanks to TechnoPORTA AQUA STOP technology door leaves finished with CPL HQ have lower edges protected against humidity.**

### EXTRA CHARGES

- inverse glazing
- investment set (extra charge added to a door frame)
- stainless steel porthole - model 1.1
- CPL finish 0,2 and 0,7 mm - GROUP II
- ventilation grille, ventilation sleeves or ventilation undercut
- reinforcement for door closer (third hinge is required)
- stainless steel porthole (model 1.1)
- transparent/frosted glazing - model 1.2
- transparent/frosted glazing - model 1.5
- push panel - both sides set (models 1.1, 1.2)
- kick panel both sides set (models 1.1, 1.2, 1.3)
- kick panel with a ventilation undercut - both sides set (models 1.1, 1.2, 1.3)
- ventilation kick panel - both sides set (models 1.1, 1.2, 1.3)
- size 100 and 110
- automatic threshold seal
- changing hollow chipboard core into chipboard core
- handle with an escutcheon

(see p. 224)

# Porta RESIST

04



Porta RESIST 1.1, Halifax Natural

Chosen models with hollow or chipboard core are classified with 3rd strength performance class.

**WE RECOMMEN**

'Investment set' additionally available. It contains 3 part hinges and lock of the highest category of use (at extra charge). The set consists of a door leaf (finished with portalamino veneer) and dedicated door frame.

vertical graining:



model 1.1



model 1.2



model 1.3



model 1.4

horizontal graining:



model 7.1



model 7.2



model 7.3



model 7.4

vertical or horizontal graining:



model B.1\*



model E.1\*



model H.1\*

vertical graining:



model 4.A



model 4.B



Porta RESIST 7.1, Halifax Natural

\* graining is in line with the direction of inlays





## AVAILABLE FINISHES

### Gladstone / Halifax ★★★★★

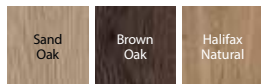

Check the possibilities of ordering bespoke door models through Porta CONTRACT, see page 261.

### AN INNOVATIVE PRODUCT ON THE MARKET

Texture of Gladstone/Halifax finish resembles real raw wood.

### PORTA RESIST - INDICATIONS FOR USE:

- Offices
- Hotels and guesthouses
- Public buildings
- Residential buildings

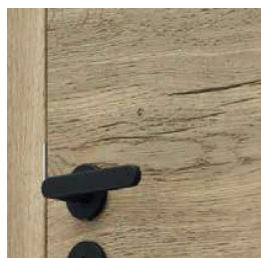

Gladstone / Halifax texture emphasizes natural wood rawness

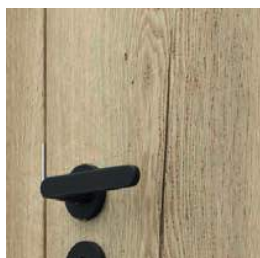

black decorative inlay, silver ones also available



glazing - model 4.A

### WE RECOMMEND!

The door leaf is skinned with a highly compressed board with very fine fibres structure. Thanks to its high density, the board guarantees resistance to impacts, attritions and scratches.



## TECHNICAL INFORMATION

### DOOR LEAF CONSTRUCTION

Honeycomb or hollow chipboard core (at an extra charge) reinforced with rails and stiles. Models 1.4, 1.7 - chipboard core, 4.B - hollow chipboard core. The construction is skinned with HDF. Lipping ABS tape on the side edges. Inlays - black or silver, 6 mm wide. 4.A and 4.B models come with 8 mm thick, tempered glass, which is an element of the construction.

### ACCESSORIES INCLUDED IN THE DOOR LEAF PRICE

- Rebated doors: two or three standard barrel hinges or PRIME hinges; non-rebated: two 3D hinges
- Lock: key lock, WC lock, or cylinder lock
- Glazing - models of gr. 1 and 7 'chinchilla' glass; frosted tempered glass; transparent glass. Models of gr. 4 - 8 mm thick frosted tempered glass.
- Round pull handle (for sliding doors)

### DOOR FRAMES

#### Recommended rebated door frames:

- Porta SYSTEM see p. 200
- MINIMAX see p. 198
- STEEL see p. 212-217

#### Recommended non-rebated door frames:

- Porta SYSTEM ELEGANCE see p. 202

### NOTES

- Norm PN EN 14351-2:2018-12.
- The door leaf is skinned with a Gladstone/Halifax board (with structure), a door frame is finished with matching CPL veneer 0,2 mm
- Ventilation grille, ventilation sleeves and preparation for shortening are not available for group 4.
- Chipboard core have preparation for shortening as a standard.
- Size '100' and '110' is not available for models 1.4, 7.4.
- Size '110' is available only with hollow chipboard. Glazing size is the same as for size, '100'.
- Size '110' is not available for models of gr. 4.
- Fixed size of glass, model 4.A.
- **Black glazing is available for model 4.A (optionally at extra charge)**

- Magnetic lock is not available for a double door.
- Double doors are available in any door leaf size combinations.
- For non-rebated double door, 'active' and 'passive' door leaves must be ordered.
- Size '80' and '90' in investment norm (clear opening width 800, 900 mm) available as a standard (applies to gr. 1 and 7) - without extra charge.
- Reinforcement for a door closer requires third hinge.
- Investment set is available only with hollow or chipboard core
- Investment set is available with a rebated door frame: Porta SYSTEM, Steel Porta SYSTEM, Steel adjustable, Corner profile - SMALL and LARGE
- Sizes, '100' and, '110' require third hinge
- PRIME or 3D hinges - packed with a door frame
- **Thanks to TechnoPORTA AQUA STOP technology door leaves finished with CPL HQ have lower edges protected against humidity.**

### EXTRA CHARGES

- size '100' and '110'
- hollow chipboard core
- chipboard core
- investment set (extra charge added to a door leaf)
- investment set (extra charge added to a door frame)
- OFFER - PRIME set
- gold 3D hinges (extra charge added to door frame price)
- third 3D hinge - silver, white, black (extra charge added to door frame price)
- third 3D hinge - gold (extra charge added to door frame price)
- ventilation grille (only group 1 and 7), ventilation sleeves or ventilation undercut
- magnetic lock with stainless steel faceplate
- magnetic lock: white, black (for non-rebated doors)
- preparation for shortening (maximum 60 mm) (apart from gr. 4)
- reinforcement for door closer (third hinge is required)
- stainless steel porthole (model 1.1, 7.1)
- automatic threshold seal
- hook lock with side pull handles (sliding doors)
- oblong pull handle for sliding doors
- caps for standard hinges
- handle with an escutcheon

(see p. 224)



# Porta FOCUS

04

TOP  
COLLECTIONS



Porta FOCUS 4.A, Natural Walnut (matt)



Porta FOCUS 4.A, Natural Walnut (matt)



model 2.0



model 4.A



model 4.A  
with black  
galizng



model 4.B

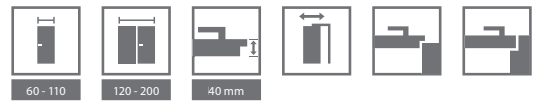

## AVAILABLE FINISHES

### Portadecor veneer ★★★★★☆

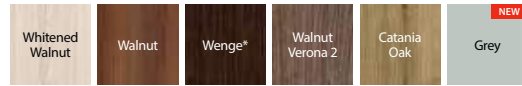

\* until stocks last

### Portasynchro 3D veneer ★★★★★☆

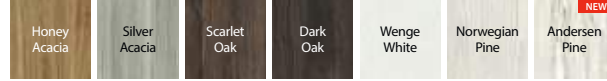

### Portaperfect 3D veneer ★★★★★☆

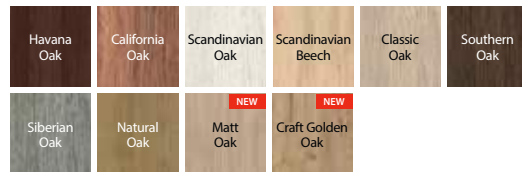

### CPL HQ 0,2 veneer ★★★★★☆



### Portalamino ★★★★★☆



Porta FOCUS



glass-door panel joint  
rebated door



glass - door panel joint  
non-rebated door



glass-door panel joint  
rebated door



glass-door panel joint  
non-rebated door

## TECHNICAL INFORMATION

### DOOR LEAF CONSTRUCTION

Honeycomb or hollow chipboard core (at an extra charge) reinforced with rails and stiles. The construction is skinned with HDF. Glazed models come with 8 mm thick, frosted tempered panel glass, which is an element of the construction. There is lipping ABS on the side edges of the doors finished with CPL.

### ACCESSORIES INCLUDED IN THE DOOR LEAF PRICE

- Rebated doors: two or three standard barrel hinges or PRIME hinges (optionally at extra charge); non-rebated: two 3D hinges
- Lock: key lock, WC lock, or cylinder lock
- Frosted, tempered glass
- Round pull handle (for sliding doors)

### DOOR FRAMES

#### Recommended rebated door frames:

- Porta SYSTEM see p. 200
- MINIMAX see p. 198
- STEEL see p. 212-217

#### Recommended non-rebated door frames:

- Porta SYSTEM ELEGANCE see p. 202
- LEVEL see p. 206

### NOTES

- Norm PN EN 14351-2:2018-12.
- Ventilation undercut in glazed models is available only for Polish Norm.
- Hollow chipboard core and chipboard core have preparation for shortening as a standard.
- Size '110' is available only with chipboard core.
- **Black glazing is available for model 4.A (optionally at extra charge)**

- Double doors are available in any door leaf size combinations. For non-rebated double door, 'active' and 'passive' door leaves must be ordered.
- 4.B model is available only with hollow chipboard core, free of extra charge.
- Size '110' is not available for models of group 4.
- **Fixed size of glass - group 2, model 4.A.**
- Magnetic lock is not available for a double door
- Sizes, 100' and, 110' require third hinge
- PRIME or 3D hinges - packed with a door frame

### EXTRA CHARGES

- size '100', '110'
- lack glazing - model 4.A
- inverse glazing
- **OFFER** for door leaves finished with CPL - Prime set
- CPL finish 0,2 - GROUP II
- hollow chipboard core
- chipboard core
- ventilation undercut or ventilation sleeves
- PRIME hinges (for dedicated door frames)
- PRIME lock with glossy faceplate (silver or gold)
- gold 3D hinges (extra charge added to door frame price)
- third 3D hinge - silver, white, black (extra charge added to door frame price)
- third 3D hinge - gold (extra charge added to door frame price)
- magnetic lock with stainless steel faceplate
- magnetic lock: white, black (for non-rebated doors)
- hook lock with side pull handles (sliding doors)
- oblong pull handle for sliding doors
- caps for standard hinges
- handle with an escutcheon

(see p. 224)

# Porta LOFT

04

**TOP**  
COLLECTIONS

Porta LOFT gives new possibilities of interior design. Edgy black and timeless white colours are the leitmotiv of this collection. They are used to finish the door frame and all the accessories. Thanks to their combination with one of Porta's veneer you can create your own, unique, product that matches almost any interior.

Porta LOFT 4.A, Halifax Natural with black glazing, steel door frame Porta SYSTEM ELEGANCE, black MATT



Porta LOFT 1.1, Halifax Natural



model 7.1



model 1.1



model 4.A  
black glazing also  
available



model 4.B



model 7.1



model 1.1



model 4.A



model 4.B



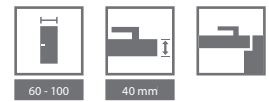

## AVAILABLE FINISHES

### Portaperfect 3D veneer ★★★★★☆

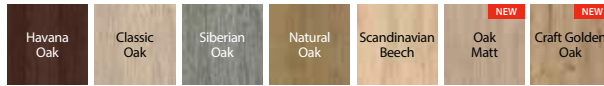

### Gladstone / Halifax ★★★★★★

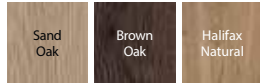

### CPL HQ 0,2 veneer ★★★★★☆

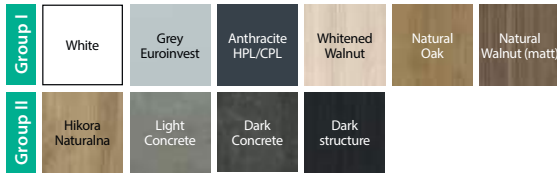

## AVAILABLE FINISHES OF DOOR FRAMES

### SUPER MATT veneer ★★★★★☆



### CPL HQ 0,2 veneer ★★★★★☆



glass-door panel joint



3D hinges in door frame colour



3D hinges in door frame colour



lock faceplate

## TECHNICAL INFORMATION

### DOOR LEAF CONSTRUCTION

Honeycomb or hollow chipboard core (at an extra charge) reinforced with rails and stiles. The construction is skinned with HDF. Glazed models come with 8 mm thick, frosted tempered panel glass, which is an element of the construction. **The distinctive feature of this collection is black or white lipping ABS on the side edges.**

### ACCESSORIES INCLUDED IN THE DOOR LEAF PRICE

- Two 3D hinges in a door frame colour- Black or White
- Lock in ABS tape colour - Black or White
- 8 mm thick frosted, tempered glass

### DOOR FRAMES

- Porta SYSTEM ELEGANCE, black or white
- Steel PORTA SYSTEM ELEGANCE, black or white

### NOTES

- Norm PN EN 14351-2:2018-12.
- Ventilation undercut in glazed models is available only for Polish Norm.
- Hollow chipboard core and chipboard core have preparation for shortening as a standard.

- 4.B model is available only with hollow chipboard core, free of extra charge.
- **Black glazing is available for model 4.A (optionally at extra charge)**
- Fixed size of glass panel -model 4.A.
- Size, 100' requires third hinge
- 3D hinges - packed with a door frame

### EXTRA CHARGES

- size '100'
- black glazing - model 4.A
- inverse glazing
- CPL finish 0,2 mm - GROUP II
- hollow chipboard core
- chipboard core
- ventilation undercut
- automatic threshold seal
- third 3D hinge (extra charge added to door frame price)
- preparation for shortening (maximum 60 mm), (group 1.1)
- handle with an escutcheon

(see p. 224)



# Nature CLASSIC

05



Nature CLASSIC 3.1, Oak 1, grain - stripes

Chosen models with hollow or chipboard core are classified with 3rd strength performance class.

#### WE RECOMMEND

'Investment set' additionally available. It contains 3 part hinges and lock of the highest category of use (at extra charge). The set consists of a door leaf (finished with portalamino veneer) and dedicated door frame.

#### HEIGHT 220

vertical graining:



model 1.1



model 1.1



model 1.2



model 1.3



model 1.4

#### NEW

horizontal graining:



model 3.1



model 7.1



model 7.2



model 7.3



model 7.4



Nature CLASSIC 3.1, Oak 1, grain -,flower'

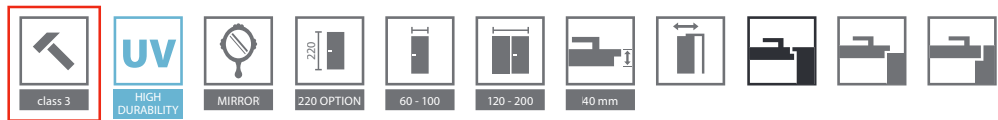

## AVAILABLE FINISHES

### Natural Select Veneer ★★★★★☆

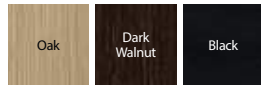

### Natural veneer - Oak ★★★★★☆



### Natural veneer - Ash ★★★★★☆



Ash veneer is available for models of group 1. Grain - ,flower'.

### Natural veneer - Walnut ★★★★★☆



Walnut veneer is available for models of group 1. Grain - ,flower'.

### Natural Satin Oak Veneer ★★★★★☆

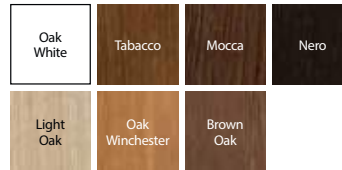

Customize colours to meet your individual needs. Send an enquiry through Porta CONTRACT. Details regarding bespoke order, see page 261.

Due to the characteristic of natural veneers, differences in colour and graining, might appear on a door leaf. These differences cannot be grounds for complaints.

Nature CLASSIC



horizontal graining  
group 7

## TECHNICAL INFORMATION

### DOOR LEAF CONSTRUCTION

Core - stabilizing infill reinforced with rails and stiles. The construction is skinned with a slim particle board which is finished with high quality natural veneer. The door leaf surface is protected by ecological water-based varnishes. Select, Natural Oak, Ash, Walnut and Satin (apart from white) veneers are hardened under UV lamp (semi-matt). Hollow chipboard core available at an extra charge.

### ACCESSORIES INCLUDED IN THE DOOR LEAF PRICE

- Rebated doors: three standard barrel hinges or PRIME hinges; non-rebated: two 3D hinges
- Lock with glossy faceplate (silver or gold): key lock, WC lock, or cylinder lock
- Glass panel - 'chinchilla' or frosted tempered glass
- Preparation for shortening (maximum 60 mm)
- Round pull handle (for sliding doors)

### DOOR FRAMES

#### Recommended rebated door frames:

- Porta SYSTEM see p. 200
- MINIMAX see p. 198
- STEEL see p. 212-217

#### Recommended non-rebated door frames:

- Porta SYSTEM ELEGANCE see p. 202
- Porta SYSTEM ELEGANCE 90 degrees see p. 202

#### Recommended door frames with a reversed rebate:

- Porta SYSTEM with a reversed rebate see p. 204

### NOTES

- Norm PN EN 14351-2:2018-12..
- **Height 220 - available for models 1.1 and 1.7; core: hollow chipboard, 3 hinges as a standard**
- Size '100' is not available for model 1.3
- Unvarnished door leaves are available in a standard product price
- **Model 3.1 is not available with Natural Satin veneer**

- Ventilation sleeves- silver or gold. 1 row.
- Double doors are available in any door leaf size combinations. For a double non-rebated door, 'active' and 'passive' door leaves must be ordered
- Magnetic lock is not available for a double door.
- Investment set is available only with hollow or chipboard core
- Investment set is available with a rebated door frame: Porta SYSTEM, Steel Porta SYSTEM, Steel adjustable, Corner profile - SMALL and LARGE
- PRIME or 3D hinges - packed with a door frame

### EXTRA CHARGES

- size '100'
- door leaf height 220 cm
- ventilation undercut or ventilation sleeves 1 row, 2 rows available only for models: 1.1, 1.2, 1.3
- stainless steel porthole (only 1.1 and 1.7 models)
- investment set (extra charge added to a door leaf)
- investment set (extra charge added to a door frame)
- reversed rebate - extra charge to a door leaf price
- reversed rebate - third 3D hinge, white, black (extra charge to a door frame price)
- reversed rebate - third 3D hinge, silver (extra charge to a door frame price)
- gold 3D hinges (extra charge added to a door frame price)
- third 3D hinge - silver, white, black (extra charge added to a door frame price)
- third 3D hinge - gold (extra charge added to a door frame price)
- magnetic lock with stainless steel faceplate
- magnetic lock: white, black (for non-rebated doors)
- hook lock with side pull handles (sliding doors)
- an oblong pull handle for sliding doors
- mirror on one side
- mirror on both sides
- hollow chipboard core
- chipboard core
- 'Satin white oak' finish
- 'Select black' finish



# Nature LINE

05



Nature LINE E.2, Mocca

HEIGHT 220



Nature LINE F.1, Mocca



model F.1



model F.1



model A.1



model B.1



model C.2



model E.2



model G.1



model H.1





## AVAILABLE FINISHES

### Natural Select Veneer ★★★★★☆

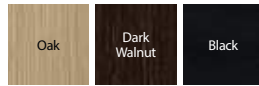

### Natural veneer - Oak ★★★★★☆



### Natural Satin Oak Veneer ★★★★★☆

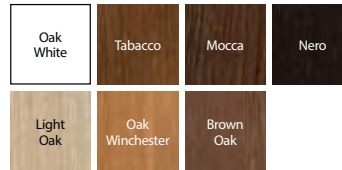

Due to the characteristic of natural veneers, differences in colour and graining, might appear on a door leaf. These differences cannot be grounds for complaints.



silver decorative inlay



silver decorative inlay

## TECHNICAL INFORMATION

### DOOR LEAF CONSTRUCTION

Core - stabilising infill reinforced with rails and stiles. The construction is skinned with slim particle board which is finished with high quality natural veneer. Door leaves are enriched with aluminium decorative inlays, 6 mm wide. The door leaf surface is protected by ecological water-based varnishes. Select, Natural Oak and Satin (apart from white) veneers are hardened under UV lamp (semi-matt). Hollow chipboard core available at extra charge.

### ACCESSORIES INCLUDED IN THE DOOR LEAF PRICE

- Rebated doors: three standard brel hinges or PRIME hinges; non-rebated: two 3D hinges
- Lock with glossy faceplate (silver or gold): key lock, WC lock, or cylinder lock
- Preparation for shortening (maximum 60 mm)
- Round pull handle (for sliding doors)

### DOOR FRAMES

#### Recommended rebated door frames:

- Porta SYSTEM see p. 200
- MINIMAX see p. 198
- STEEL see p. 212-217

#### Recommended non-rebated door frames:

- Porta SYSTEM ELEGANCE see p. 202
- Porta SYSTEM ELEGANCE 90 degrees see p. 202

#### Recommended door frames with reversed rebate:

- Porta SYSTEM with reversed rebate see p. 204

### NOTES

- Norm PN EN 14351-2:2018-12.
- **Height 220: core hollow chipboard; 3 hinges as a standard**
- Ventilation sleeves - silver or gold. 1 or 2 rows
- Double doors are available in any door leaf size combinations. For a double non-rebated door, 'active' and 'passive' door leaves must be ordered
- Magnetic lock is not available for a double door
- PRIME or 3D hinges - packed with a door frame

### EXTRA CHARGES

- size '100'
- door leaf height 220 cm
- ventilation sleeves or ventilation undercut
- hook lock with side pull handles (sliding doors)
- an oblong pull handle for sliding doors
- reversed rebate - extra charge to a door leaf price
- reversed rebate - third 3D hinge, white, black (extra charge to a door frame price)
- reversed rebate - third 3D hinge, silver (extra charge to a door frame price)
- gold 3D hinges (extra charge added to a door frame price)
- third 3D hinge - silver, white, black (extra charge added to a door frame price)
- extra charge added to door frame price
- third 3D hinge - gold (extra charge added to a door frame price)
- magnetic lock with stainless steel faceplate
- magnetic lock: white, black (for non-rebated doors)
- hollow chipboard core
- door leaf with reversed rebate
- White Oak -Satin finish
- Black - Natural Select finish
- a handle with an escutcheon

(see p. 224)



# Nature VECTOR

05



Nature VECTOR J, Oak 1

## NEW

Nature VECTOR collection - doors in natural veneer: White Oak Satin. The collection consists of the most frequently chosen decorative milling patterns of the Porta VECTOR collection and a new dedicated one - pattern J.



Nature VECTOR J, Oak 1



model B



model E



model J



model U



model V



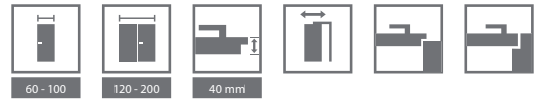

## AVAILABLE FINISHES

### Natural Satin Oak Veneer ★★★★★☆



### Natural veneer Oak ★★★★★☆



Give free rein to your imagination! Do you have your own door concept? You can order any milling with Porta CONTRACT, details regarding bespoke orders see page 261.



decorative milling close up - visible texture of Natural Oak

## TECHNICAL INFORMATION

### DOOR LEAF CONSTRUCTION

Core - stabilising infill reinforced with rails and stiles. The construction is skinned with a slim particle board which is finished with high quality natural veneer. The door leaf surface is protected by ecological water-based varnishes. Hollow chipboard core available at an extra charge.

### ACCESSORIES INCLUDED IN THE DOOR LEAF PRICE

- Rebated doors: three standard barrel hinges or PRIME hinges; non-rebated: two 3D hinges
- Three hinges for size '100'
- Lock with glossy faceplate (silver or gold): key lock, WC lock, or cylinder lock
- Round pull handle (for sliding doors)

### DOOR FRAMES

#### Recommended rebated door frames:

- Porta SYSTEM see p. 200
- MINIMAX see p. 198
- STEEL see p. 212-217

#### Recommended non-rebated door frames:

- Porta SYSTEM ELEGANCE see p. 202
- Porta SYSTEM ELEGANCE 90 degrees see p. 202

### NOTES

- Norm PN EN 14351-2:2018-12.
- **Height, 220': core: hollow chipboard; three hinges as a standard**
- Double doors are available in any door leaf size combinations.
- Passive door leaf (panel) available in sizes: 30', 40', 50' - without a decorative milling
- Magnetic lock is not available for a double door.
- Reinforcement for a door closer requires third hinge.
- Model E comes with horizontal wood graining, other models with vertical
- PRIME or 3D hinges - packed with a door frame

### EXTRA CHARGES

- size '100'
- hollow chipboard core
- Ventilation sleeves or ventilation undercut
- preparation for shortening (maximum 60 mm)
- gold 3D hinges (extra charge added to a door frame price)
- third 3D hinge - silver, white, black (extra charge added to a door frame price)
- third 3D hinge - gold (extra charge added to a door frame price)
- magnetic lock with stainless steel faceplate
- magnetic lock: white, black (for non-rebated doors)
- reinforcement for door closer (third hinge is required)
- hook lock with side pull handles (sliding doors)
- an oblong pull handle for sliding doors
- a handle with an escutcheon

(see p. 224)



# Nature LOFT

05



Nature LOFT 1.1, Oak 1, „striped“ wood grain

Nature LOFT gives new possibilities of interior design. Black colour is the leitmotiv of this collection. It is used to finish the door frame and all the accessories.



Nature LOFT 1.1, Oak 1, „flower“ wood grain



1.1, Oak 1 - „flower“ wood grain



1.1, Oak 1 - „striped“ wood grain



1.1, Ash



1.1, Walnut







60 - 100



40 mm



## AVAILABLE FINISHES

### Natural veneer - Oak ★★★★★☆

wood graining -,flower' and  
,striped'

### Natural veneer - Ash ★★★★★☆



wood graining -,flower'

### Natural veneer - Walnut ★★★★★☆



wood graining -,flower'

Due to the characteristic of natural veneers, differences in colour and graining, might appear on a door leaf. These differences cannot be grounds for complaints.

## AVAILABLE FINISHES OF DOOR FRAMES

### Natural Select Veneer ★★★★★☆



Black

Nature LOFT



lock faceplate

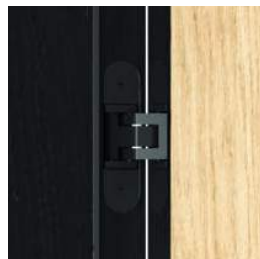

3D hinges in door frame colour

## TECHNICAL INFORMATION

### DOOR LEAF CONSTRUCTION

Honeycomb or hollow chipboard core reinforced with rails and stiles (optionally at extra charge). The construction is skinned with a particle board finished with natural veneer. Side edges finished with Natural Select Veneer. **The distinctive features of this collection are black lipping on the side edges and black accessories.**

### ACCESSORIES INCLUDED IN THE DOOR LEAF PRICE

- Two 3D hinges - Black
- Lock in ABS tape colour - Black

### DOOR FRAMES

- Porta SYSTEM ELEGANCE, black see p. 202
- Porta SYSTEM ELEGANCE 90 degrees, black see p. 202

### NOTES

- Norm PN EN 14351-2:2018-12.
- Hollow chipboard core and chipboard core have preparation for shortening as a standard.
- Size, 100' requires third hinge
- 3D hinges - packed with a door frame.

### EXTRA CHARGES

- size '100'
- hollow chipboard core
- ventilation undercut
- third 3D hinge (extra charge added to door frame price)



# Nature GRANDE

05



Nature GRANDE A.1, Black



Nature GRANDE A.0, Black



model A.0



model A.1



model B.0



model B.1



model B.3



model C.0



model C.1



model D.0



model D.1





## AVAILABLE FINISHES

### Natural Select Veneer ★★★★★☆

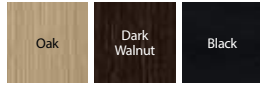

### Natural veneer - Oak ★★★★★☆



### Natural Satin Oak Veneer ★★★★★☆

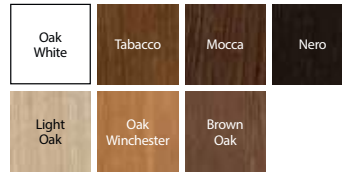

Due to the characteristic of natural veneers, differences in colour and graining, might appear on a door leaf. These differences cannot be grounds for complaints.

Nature GRANDE



a door with glazing



flat panel

## TECHNICAL INFORMATION

### DOOR LEAF CONSTRUCTION

Frame and panel construction. A door leaf is finished with natural veneer. Surface is protected by ecological water-based varnishes. Select, Natural Oak and Satin (apart from white) veneers are hardened under UV lamp (semi-matt)

### ACCESSORIES INCLUDED IN THE DOOR LEAF PRICE

- Rebated doors: three standard barrel hinges or PRIME hinges; non-rebated: two 3D hinges
- Lock with glossy faceplate (silver or gold): key lock, WC lock, or cylinder lock
- Frosted tempered glass
- Preparation for shortening (maximum 60 mm)
- Round pull handle (for sliding doors)

### DOOR FRAMES

#### Recommended rebated door frames:

- Porta SYSTEM see p. 200
- MINIMAX see p. 198

#### Recommended non-rebated door frames:

- Porta SYSTEM ELEGANCE see p. 202
- Porta SYSTEM ELEGANCE 90 degrees see p. 202

#### Recommended door frames with reversed rebate:

- Porta SYSTEM with reversed rebate see p. 204

### NOTES

- Norm PN EN 14351-2:2018-12.
- Double doors are available in any door leaf size combinations.
- Magnetic lock is not available for a double door.
- PRIME or 3D hinges - packed with a door frame

### EXTRA CHARGES

- size '100'
- ventilation undercut
- reversed rebate - extra charge to a door leaf price
- reversed rebate - third 3D hinge, white, black (extra charge added to door frame price)
- reversed rebate - third 3D hinge, silver (extra charge added to door frame price)
- gold 3D hinges (extra charge added to a door frame price)
- third 3D hinge - silver, white, black (extra charge added to a door frame price)
- third 3D hinge - gold (extra charge added to a door frame price)
- magnetic lock with stainless steel faceplate
- magnetic lock: white, black (for non-rebated doors)
- hook lock with side pull handles (sliding doors)
- an oblong pull handle for sliding doors
- White Oak - Satin finish
- Black - Natural Select finish
- a handle with an escutcheon

(see p. 224)



# Nature SPACE

05



Nature SPACE G.1 with black glazing, Brown Oak



Nature SPACE G.1, Brown Oak



model F.1



model G.1  
black glazing also  
available



model H.1





## AVAILABLE FINISHES

### Natural Select Veneer ★★★★★☆



### Natural veneer - Oak ★★★★★☆



### Natural Satin Oak Veneer ★★★★★☆

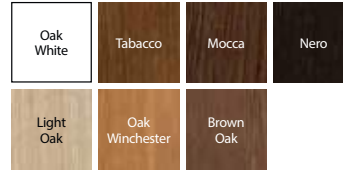

Due to the characteristic of natural veneers, differences in colour and graining, might appear on a door leaf. These differences cannot be grounds for complaints.



door with black glazing



door with frosted glazing



door with frosted glazing

Nature SPACE

## TECHNICAL INFORMATION

### DOOR LEAF CONSTRUCTION

Glued softwood. Door leaves contain rails and stiles finished with natural veneer. Thanks to applied technology, door leaf is very resistant to deformation. Surface is protected by ecological water-based varnishes. Select, Natural Oak and Satin (apart from white) veneers are hardened under UV lamp (semi-matt).

### ACCESSORIES INCLUDED IN THE DOOR LEAF PRICE

- Rebated doors: two or three standard barrel hinges or PRIME hinges (optionally at extra charge); non-rebated: two 3D hinges
- Lock with glossy faceplate (silver or gold): key lock, WC lock, or cylinder lock
- Frosted tempered glass, 8 mm thick

### DOOR FRAMES

#### Recommended rebated door frames:

- Porta SYSTEM see p. 200
- MINIMAX see p. 198
- STEEL see p. 212-217

#### Recommended non-rebated door frames:

- Porta SYSTEM ELEGANCE see p. 202
- Porta SYSTEM ELEGANCE 90 degrees see p. 202

### NOTES

- Norm PN EN 14351-2:2018-12.
- Ventilation sleeves- silver or gold. 1 row (model F.1, G.1)
- Double doors are available in any door leaf size combinations. For a double non-rebated door, 'active' and 'passive' door leaves must be ordered
- Magnetic lock is not available for a double door.
- PRIME or 3D hinges - packed with a door frame
- **Model G.1 is available with black glazing (optionally at extra charge)**

### EXTRA CHARGES

- size '100'
- black glazing - model G.1
- ventilation sleeves (model F.1, G.1)
- magnetic lock with stainless steel faceplate
- magnetic lock: white, black (for non-rebated doors)
- hook lock with side pull handles (sliding doors)
- an oblong pull handle for sliding doors
- gold 3D hinges (extra charge added to a door frame price)
- third 3D hinge - silver, white, black (extra charge added to a door frame price)
- third 3D hinge - gold (extra charge added to a door frame price)
- 'Satin white oak' finish
- a handle with an escutcheon

(see p. 224)



# Nature CONCEPT

05



Nature CONCEPT C.6, Oak

WE RECOMMEND

- Traditional frame and panel



Nature CONCEPT C.6, Oak



model A.0



model A.3



model A.9



model B.0



model D.0



model C.0



model C.2



model C.4



model C.6



model K.0



model K.1



model K.2



model K.3

Check more models  
of this collection  
[on a website](#)





## AVAILABLE FINISHES

### Natural Select Veneer ★★★★★☆



### Natural veneer - Oak ★★★★★☆



### Natural Satin Oak Veneer ★★★★★☆

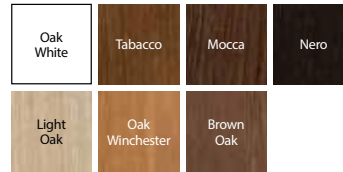

Due to the characteristic of natural veneers, differences in colour and graining, might appear on a door leaf. These differences cannot be grounds for complaints.

Nature  
CONCEPT



flat panel – model A.0



frosted glass panel – model A.9



flat panel – model B.0



decorative inlays – model D.0

## TECHNICAL INFORMATION

### DOOR LEAF CONSTRUCTION

Glued laminated with MDF. The construction is finished with natural veneer. Thanks to applied technology, door leaf is very resistant to deformations. Model D.0 - aluminium decorative inlays, 6 mm wide. Surface is protected by ecological water-based varnishes. Select, Natural Oak and Satin (apart from white) veneers are hardened under UV lamp (semi-matt).

### ACCESSORIES INCLUDED IN THE DOOR LEAF PRICE

- Rebated doors: two or three standard barrel hinges or PRIME hinges (optionally at extra charge); non-rebated: two 3D hinges
- Lock with glossy faceplate (silver or gold): key lock, WC lock, or cylinder lock
- Frosted tempered glass
- Preparation for shortening, maximum 60 mm
- Oblong pull handle (for sliding doors)

### DOOR FRAMES

#### Recommended rebated door frames:

- Porta SYSTEM see p. 200
- MINIMAX see p. 198

#### Recommended non-rebated door frames:

- Porta SYSTEM ELEGANCE see p. 202
- Porta SYSTEM ELEGANCE 90 degrees see p. 202

### NOTES

- Norm PN EN 14351-2:2018-12..
- Ventilation sleeves- silver or gold, 1 row.
- Double doors are available in any door leaf size combinations. For a double non-rebated door, 'active' and 'passive' door leaves must be ordered
- Magnetic lock is not available for a double door.
- PRIME or 3D hinges - packed with a door frame

### EXTRA CHARGES

- size '100'
- ventilation sleeves or ventilation undercut
- hook lock with side pull handles (sliding doors)
- an oblong pull handle for sliding doors
- gold 3D hinges (extra charge added to a door frame price)
- third 3D hinge - silver, white, black (extra charge added to door frame price)
- third 3D hinge - gold (extra charge added to door frame price)
- magnetic lock with stainless steel faceplate
- magnetic lock: white, black (for non-rebated doors)
- 'Satin white oak' finish
- a handle with an escutcheon

(see p. 224)



# SEVILLA

05



SEVILLA solid, White Oak



SEVILLA solid, White Oak



SEVILLA  
solid



SEVILLA  
with glazing



side  
panel I



side  
panel J







## AVAILABLE FINISHES

### Natural veneer - Oak ★★★★★☆



Due to the characteristic of natural veneers, differences in colour and graining, might appear on a door leaf. These differences cannot be grounds for complaints.

### Natural Satin Oak Veneer ★★★★★☆

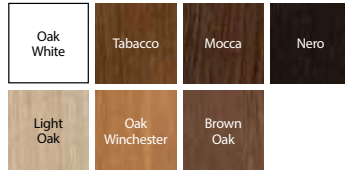

SEVILLA  
raised panel profile

SEVILLA

## TECHNICAL INFORMATION

### DOOR LEAF CONSTRUCTION

Glued softwood with MDF. The construction is finished with natural veneer. Thanks to applied technology, door leaf is very resistant to deformations. Surface is protected by ecological water-based varnishes. Natural Oak and Satin (apart from white) veneers are hardened under UV lamp (semi-matt).

### ACCESSORIES INCLUDED IN THE DOOR LEAF PRICE

- Rebated doors: three standard barrel hinges or PRIME hinges; non-rebated: two 3D hinges
- Lock with glossy faceplate (silver or gold): key lock, WC lock, or cylinder lock
- Glass panels - 'chinchilla' or frosted tempered glass preparation for shortening, maximum 60 mm. A door leaf with a ventilation slit - shortening up to 40 mm
- Round pull handle (for sliding doors)
- A seal fitting the glass panel

### DOOR FRAMES

#### Recommended rebated door frames:

- Porta SYSTEM see p. 200
- MINIMAX see p. 198

#### Recommended non-rebated door frames:

- Porta SYSTEM ELEGANCE see p. 202
- Porta SYSTEM ELEGANCE 90 degrees see p. 202

### NOTES

- Norm PN EN 14351-2:2018-12.
- Unvarnished door leaves are available at standard product price
- Ventilation sleeves - silver or gold. 1 row.
- Double doors are available in any door leaf size combinations. For a double non-rebated door, 'active' and 'passive' door leaves must be ordered
- Magnetic lock is not available for a double door
- Side panels in size '40'
- PRIME or 3D hinges - packed with a door frame

### EXTRA CHARGES

- size '100'
- ventilation sleeves, ventilation undercut or ventilation slit
- gold 3D hinges (extra charge added to a door frame price)
- third 3D hinge - silver, white, black (extra charge added to a door frame price)
- third 3D hinge - gold (extra charge added to a door frame price)
- magnetic lock with a stainless steel faceplate
- magnetic lock black or whit, for rebated doors
- hook lock with side pull handles (sliding doors)
- an oblong pull handle for sliding doors
- an astragal for double doors
- White Oak -Satin finish
- a mirror on one side
- a handle with an escutcheon

(see p. 224)





# MADRID, CORDOBA, TOLEDO

05



CORDOBA large muntin, panel K Tabacco



CORDOBA solid, Tabacco



MADRID solid



MADRID small glazing



MADRID muntin



MADRID large muntin



CORDOBA solid



CORDOBA small glazing



CORDOBA muntin



CORDOBA large muntin



side panel A



side panel K



TOLEDO solid



TOLEDO model 1



TOLEDO model 2



TOLEDO model 3



TOLEDO model 5





## AVAILABLE FINISHES

### Natural veneer - Oak ★★★★★☆



Due to the characteristic of natural veneers, differences in colour and graining, might appear on a door leaf. These differences cannot be grounds for complaints.

### Natural Satin Oak Veneer ★★★★★☆

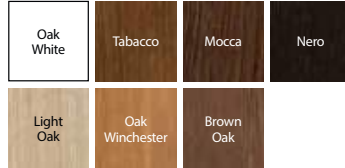

**CORDOBA**  
minimalist rails and stiles  
chamfered with 20°



**TOLEDO**  
minimalist rails and stiles  
chamfered with 20°



**MADRID**  
decorative profiled stile



**MADRYT**  
decorative covered panel

MADRID, CORDOBA,  
TOLEDO

## TECHNICAL INFORMATION

### DOOR LEAF CONSTRUCTION

Glued softwood with MDF. The construction is finished with natural veneer. Thanks to applied technology, door leaf is very resistant to deformations. Surface is protected by ecological water-based varnishes. Natural Oak and Satin (apart from white) veneers are hardened under UV lamp (semi-matt). Rails and stiles of Cordoba and Toledo are chamfered with 20°.

### ACCESSORIES INCLUDED IN THE DOOR LEAF PRICE

- Rebated doors: three standard barrel hinges or PRIME hinges; non-rebated: two 3D hinges
- Lock with glossy faceplate (silver or gold): key lock, WC lock, or cylinder lock
- Glass panels - 'chinchilla' or frosted tempered glass preparation for shortening, maximum 60 mm. A door leaf with a ventilation slit - shortening up to 40 mm
- Round pull handle (for sliding doors)
- A seal fitting the glass panel

### DOOR FRAMES

#### Recommended rebated door frames:

- Porta SYSTEM see p. 200
- MINIMAX see p. 198

#### Recommended non-rebated door frames:

- Porta SYSTEM ELEGANCE see p. 202
- Porta SYSTEM ELEGANCE 90 degrees see p. 202

### NOTES

- Norm PN EN 14351-2:2018-12.
- Unvarnished door leaves are available at standard product price
- Ventilation sleeves- silver or gold, 1 row.
- Double doors are available in any door leaf size combinations. For a double non-rebated door, 'active' and 'passive' door leaves must be ordered
- Magnetic lock is not available for a double door
- Side panels in size '40'
- PRIME or 3D hinges- packed with a door frame

### EXTRA CHARGES

- size '100'
- ventilation sleeves, ventilation undercut or ventilation slit
- gold 3D hinges (extra charge added to a door frame price)
- third 3D hinge - silver, white, black (extra charge added to a door frame price)
- third 3D hinge - gold (extra charge added to a door frame price)
- magnetic lock with a stainless steel faceplate
- magnetic lock black or white, for rebated doors
- hook lock with side pull handles (sliding doors)
- an oblong pull handle for sliding doors
- an astragal for double doors
- White Oak - Satin finish
- a handle with an escutcheon

(see p. 224)



# Villadora RETRO

05



Villadora RETRO, Residence 0, Module RETRO, White Oak



Villadora RETRO Residence 0, Oak White



Capital 0

Capital 1

Residence 0

Residence 2



Delarte 0

Delarte 1

Delarte 2

Delarte 3



Empire 0

Empire 1





## AVAILABLE FINISHES

### Natural Satin Oak Veneer ★★★★★☆



Due to the characteristic of natural veneers, differences in colour and graining, might appear on a door leaf. These differences cannot be grounds for complaints.



decorative moulding with a raised panel

## TECHNICAL INFORMATION

### DOOR LEAF CONSTRUCTION

Frame and panel construction. Rails and stiles made of high quality softwood and wood-based materials, finished with Natural Oak veneer. Specially selected satin tempered glass. Decorative mouldings/beads made of solid oak. The door leaf surface is protected by ecological water-based varnishes.

### ACCESSORIES INCLUDED IN THE DOOR LEAF PRICE

- Lock with glossy faceplate (silver or gold): key lock, WC lock, or cylinder lock
- Plain satin glass
- Preparation for shortening (maximum 60 mm)

### DOOR FRAMES

- Recommended rebated door frame:**
- Villadora RETRO see p. 210

### NOTES

- Norm PN EN 14351-2:2018-12.
- Doors are equipped with 3 PCs of golden hinges – hinges packed with a frame  
Option of purchasing caps for hinges in a few colours: glossy golden, old gold, glossy silver- see extra charges
- Double doors are available in any door leaf size combinations.
- Magnetic lock is not available for a double door

### EXTRA CHARGES

- ventilation sleeves 1 row
- magnetic lock
- ventilation undercut, ventilation slit
- caps for Villadora hinges
- handle with an escutcheon

(see p. 224)

# Folding doors

06



ALFA, BETA, White

## ALFA



HOW TO OPEN THE DOOR\* (top view)

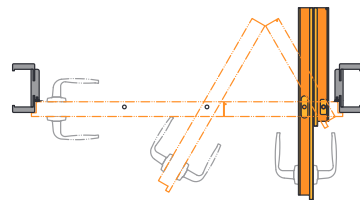

Right door

### A REBATED DOOR LEAF

The complete set consists of:

- track system
- two-part door leaf
- Porta SYSTEM door frame (modified)



See the ALFA door  
[www.porta.com.pl/dm/alfabeta.wmv](http://www.porta.com.pl/dm/alfabeta.wmv)

## BETA



HOW TO OPEN THE DOOR\* (top view)

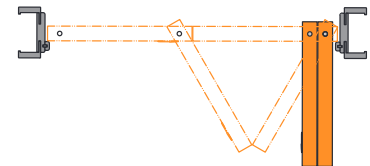

Right door

### A NON-REBATED DOOR LEAF

The complete set consists of:

- track system
- two-part door leaf
- Porta SYSTEM door frame (modified)



See the BETA door  
[www.porta.com.pl/dm/alfabeta.wmv](http://www.porta.com.pl/dm/alfabeta.wmv)

\*NOTE: Due to fittings specifics there is a slight narrowing of clear opening width when the door is open. (about 10 cm).



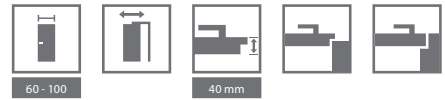

## AVAILABLE FINISHES

### Standard paint ★★★★★☆



### Portadecor veneer ★★★★★☆



\* until stocks last

### Portasynchro 3D veneer ★★★★★☆



### Portaperfect 3D veneer ★★★★★☆

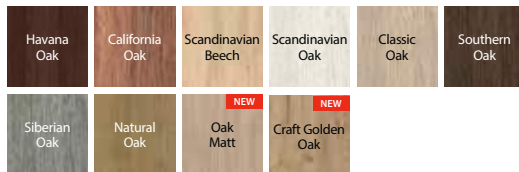

### CPL HQ 0,2 veneer ★★★★★☆

Group I	White	Grey Euroinvest	Anthracite HPL/CPL	Whitened Walnut	Oak Milano 1	Sand Beech
	Natural Oak	Natural Walnut (matt)	Orzech Modena 1	Oak Milano 4	Oak Milano 5	Craft Golden Oak (NEW)
Group II	Natural Hickory	Light Concrete	Dark Concrete	Dark structure	Black	

ALFA, BETA



how to open / fold ALFA door leaves



how to open / fold BETA door leaves

## TECHNICAL INFORMATION

### DOOR LEAF CONSTRUCTION

Honeycomb core or hollow chipboard core (at an extra charge) reinforced with plywood rails and stiles. Alfa – a two-part door, unsymmetrically divided, with a standard lock in a door leaf and a tongue strike in a door frame. Beta – a two part door, symmetrically divided without a lock.

### ACCESSORIES INCLUDED IN THE PRICE

- Track (BETA)
- Seal
- Three silver hidden hinges
- Lock: key lock, WC lock, cylinder lock (ALFA)
- Tongue strike (ALFA)
- Round pull handle (BETA)

### DOOR FRAMES

- Modified Porta SYSTEM, adjustment range from B to K see p. 200.

### NOTES

- National Technical Assessment ITB-KOT-2017/0184 issue 1
- Size '100' is not available for BETA.
- Dimensions see Table 7, page 212

### EXTRA CHARGES

- size '100' (ALFA only)
- hollow chipboard core
- door leaf: CPL 0,2 mm finish - GROUP II
- door frame: CPL 0,2 mm finish - GROUP II
- ventilation sleeves, ventilation undercut
- price of ALFA track (extra charge to the set)
- BETA track is included in door frame price
- a handle with an escutcheon

(see p. 224)

# Sliding systems

06



Sliding system PORTA, Porta CONCEPT, A.9, Grey

ON WALL-MOUNTED SLIDING SYSTEMS

## PORTA



**The complete set consists of:**

- on wall-mounted sliding system (track)
- a door leaf (sliding version)
- a door frame to suit on wall sliding system (tunnel version)

## ALU

NEW



**The set consists of:**

- on wall-mounted sliding system (track)
- a door leaf (sliding version)
- a door frame to suit on wall sliding system (tunnel version)







## AVAILABLE FINISHES

Portadecor  
Portasynchro 3D

★★★

Portadur  
Premium veneer  
Natural Select  
Natural Oak  
Natural Oak Satin

★★★★

Portaperfect 3D  
CPL HQ  
Gladstone/Halifax

★★★★★

Finishes charts see page 250 – 257.

PORTA, ALU

**NOTE!** Any sliding version door leaf is compatible with System Porta and ALU.

## TECHNICAL INFORMATION

### System PORTA

#### CONSTRUCTION OF PORTA SLIDING SYSTEM

On Wall Sliding system consists of: a rail bar with trolleys, rail cover & door stop. Rail cover and a door stop are made of chipboard and MDF. If you decide to choose Natural Veneer for your Door, this will be finished with semi-matt varnish.

#### ACCESSORIES INCLUDED IN THE PRICE

- A rail with trolleys
- A lock strike
- Self-adhesive brush seal
- Guide element which stabilizes the door leaf. Floor-mounted.

#### DOOR FRAMES

- Porta SYSTEM door frame, 'tunnel' option see p. 200.
- Dimensions see page 242, Table 7.

#### NOTES

- National Technical Assessment ITB-KOT-2017/0184 edition 1.
- **Set is reversible (left/right). Opening direction can be changed by installing door stop (jamb) on right or left side of Porta System tunnel.**

#### EXTRA CHARGES

- CPL 0,2 mm finishes - GROUP II
- Natural veneer finish - White Oak Satin
- Natural veneer finish - Satin Black

### System ALU

#### CONSTRUCTION OF ALU SLIDING SYSTEM

Offered system consists of: a rail and a construction profile supporting the door leaf. Both elements are made of nicely looking aluminium.

#### ACCESSORIES INCLUDED IN THE PRICE

- Guide element which stabilizes the door leaf. Floor-mounted.

#### DOOR FRAMES

- Porta SYSTEM frame 'tunnel', see dimensions see page 244, Table 7.

#### NOTES

- Set is reversible (left/right).
- In order to assemble the track system, a door leaf and a 'tunnel' door frame correctly, door leaf must be one size bigger. E.g track system and 'tunnel' size '70' goes with door leaf '80', track system and 'tunnel' '80' goes with a door leaf '90', '150' --> 2x '80', '170' --> 2x '90' etc,
- Hook lock is not available.

# Sliding systems

06



Sliding system COMPACT, Porta CONCEPT A.9, Scandinavian Oak

## The set consists of:

- a 'tunnel frame', dedicated for a wall -125 mm thick
- galvanized steel pocket dedicated for a wall -125 mm thick
- a door leaf - sliding option (not included in the of COMPACT system).

## POCKET DOOR SYSTEM

# COMPACT

### HOW TO OPEN THE DOOR (top view)

Discreet framework for installation in a plasterboard wall gives an opportunity to have a door in interiors, where a traditional hinged door would spoil design concept or would be even impossible to install.

Pocket door system COMPACT  
(,tunnel' frame, metal cassette (pocket) dedicated for a wall 125 mm thick)

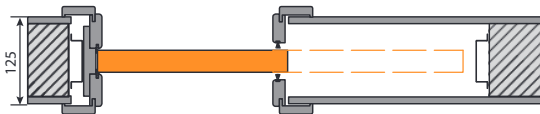

hook lock  
COMPACT sliding system



metal cassette (pocket)  
COMPACT sliding system

COMPACT ,tunnel' frames are dedicated for wall thicknesses 100 mm and 150 mm.

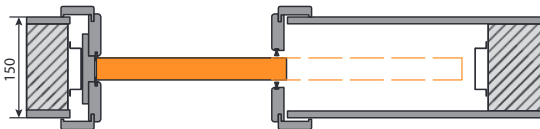
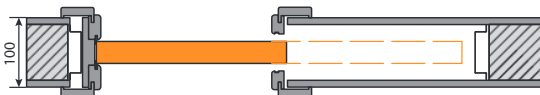

**NOTE!** Porta Compact tunnel frame is dedicated to work together with Porta pockets and pockets of leading European producers. Before installing Compact tunnel frame along with a pocket not produced by PORTA, it is required to check So/Ho dimensions.



## SLIDING SYSTEM 'COMPACT' - AVAILABLE FINISHES

Portadecor  
Portasynchro 3D ★★★

Portadur  
Premium veneer ★★★★★

Portaperfect 3D  
CPL HQ  
Gladstone/Halifax ★★★★★

Finishes charts, see page 215 – 221.



Possibility of ordering 'tunnel' in natural veneer through Porta CONTRACT, see page 261.

COMPACT

**NOTE!** Any sliding version door leaf is compatible with Compact system.

## TECHNICAL INFORMATION

### COMPACT SYSTEM CONSTRUCTION

Offered system for a 125 mm thick wall, consists of: a 'tunnel frame' made of chipboard and MDF; galvanized steel cassette with a running track, which are a pocket construction inside the wall.

### ACCESSORIES IN THE COMPACT SYSTEM PRICE

- Pocket is dedicated for a wall -125 mm thick
- Rail with trolleys and a floor-mounted element which guides the door leaf
- Hook lock strike (optionally, at an extra charge)
- Anti-dust brush seal. Pressed in.
- 'Tunnel' for a wall 125 mm thick

### DOOR FRAMES

- Door frames -'tunnel' option. Available for wall thicknesses: 100 mm, 125 mm and 150 mm
- 'Tunnel' door frame dedicated for a wall thickness 125 mm is compatible with the PORTA pocket
- All of above mentioned 'tunnel frames' are compatible with pockets of leading European producers ( $H_p/S_p$  dimensions must be checked)
- COMPACT, dimensions see page 244, Table 7.

### NOTES

- Pocket system is dedicated for 125 mm thick plasterboard walls.
- It is possible to order additional extensions for symmetrical and unsymmetrical 'tunnel frames' (bespoke order).
- Tunnel 100 mm is available with door leaves without glazing beads/decorative mouldings

### EXTRA CHARGES

- coordination kit for a double door (open/close)
- CPL 0,2 mm finish - GROUP II

# Sliding systems

06



Sliding system BLACK, type REA

## BLACK

## SLIDE



REA type



LUNA type



model 1



model 2



model 3



model 4



model 5



## AVAILABLE FINISHES

### BLACK System

Premium paint ★★★★★☆



UV acrylic paint ★★★★★☆



### SLIDE System

Gladstone / Halifax ★★★★★★

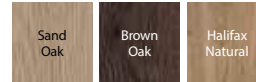

Portaperfect 3D veneer ★★★★★☆

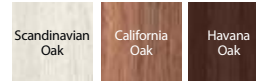

BLACK, SLIDE



pull BLACK 1

## TECHNICAL INFORMATION

### System BLACK

#### DOOR LEAF CONSTRUCTION

Honeycomb or hollow chipboard core. The construction is skinned with HDF.

#### ACCESSORIES INCLUDED IN THE PRICE

- Track 2000 mm

#### NOTES

- Technical Assessment AT 15-6515/2016
- Set is reversible (left/right)
- Set is dedicated to be mounted on wall opening one size smaller than standard. See details see p. 211
- Hook lock is not available.
- For a double door leaf set the following parts must be ordered: two sliding systems, two door leaves and a bracket
- In case of using spacers there is a possibility to move the door leaf away from the wall - 10 mm
- Black system, type LUNA can be ordered with any door leaf in sliding version
- Black system, type REA can be applied only with door leaves with hollow chipboard core

#### EXTRA CHARGES

- Hollow chipboard core
- an oblong pull
- Black 1 pull
- Set of two soft-closers with anti-slam
- Bracket for double door solutions
- Set of 5 spacers

### System SLIDE

#### DOOR LEAF CONSTRUCTION

Honeycomb or hollow chipboard core. The construction is skinned with HDF.

#### ACCESSORIES INCLUDED IN THE PRICE

- Track 2000 mm
- A set of two Soft-Closes with Anti-Slam

#### NOTES

- Technical Assessment AT 15-6515/2016
- Set is reversible (left/right)
- Set is dedicated to be mounted on wall opening one size smaller than standard. See details 7 na see p. 244.
- Hook lock is not available.

#### EXTRA CHARGES

- an oblong pull

# Sliding systems

06



Sliding system EFEKT, Sand Oak

## EFEKT



opened door



closed door





## AVAILABLE FINISHES

### Premium paint ★★★★★☆



### Gladstone / Halifax ★★★★★★

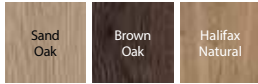

### Portaperfect 3D veneer ★★★★★☆

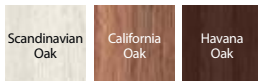

See installation video  
<https://www.youtube.com/watch?v=MCaTX1sp590>

Porta EFEKT

Porta EFEKT is a CONCEALED system of sliding doors with soft-closers ensuring comfort of use. The Porta EFEKT sliding system consists of:

- two tracks hidden in the door leaf,
- a bearing upper trolley with an intuitive installation and adjustment system enabling adaptation to wall unevenness,
- bearing lower trolleys, ensuring quiet and trouble-free exploitation even on floors with grouts.

Correctly chosen size of the door leaf allows for smooth regulation of the opening degree: partially open to open, maintaining the full light PASSAGE

## TECHNICAL INFORMATION

### DOOR LEAF CONSTRUCTION

Hollow chipboard core. The construction is skinned with HDF.

### ACCESSORIES INCLUDED IN THE PRICE

- Tracks

### NOTES

- Norm PN EN 14351-2:2018-12.
- Hook lock is not available.
- load capacity of the system 80 kg
- The set is dedicated to be mounted on wall opening three sizes smaller than standard.
- E.g. wall opening,60' requires door leaf,90'
- The gap between door leaf and a wall: 10 mm. During installation, this dimension can be increased by using a spacer for top trolley (spacer is not a part of the set). The second option is to order a door leaf fitted to needed gap size (Contract Department).
- See details see p. 211

### EXTRA CHARGES

- sizes,100' and,110'
- an oblong pull

# Frameless sliding system

06



Frameless sliding system, Premium paint

## POCKET SLIDING SYSTEM

# FRAMELESS

### DOOR OPENING SYSTEM (top view)

Minimalist solution. Sliding leaves concealed in the wall.  
The system does not require the use of door frames and architraves.  
The cassette is designed for installation in plasterboard walls.

The sliding system is designed for walls of 100 mm in thickness..



Sliding system for 125 mm thick walls..



door leaf with hook lock



## AVAILABLE FINISHES

### Premium paint ★★★★★☆



### Backing veneer /for self-painting and wallpapering



dedicated pulls  
(round or square)

Frameless sliding  
system

## TECHNICAL INFORMATION

### DOOR LEAF CONSTRUCTION

Honeycomb or hollow core (at extra charge). The construction is skinned with HDF. Available two types of finish:

- Prime finish ready for painting or wallpapering. Edges have lipping that allows painting.
- White Premium Paint finish

### SLIDING SYSTEM CONSTRUCTION

The sliding system is made of aluminium profiles adapted for installation in plasterboard or solid brick walls. Can be used with 40 mm thick door leaves.

The system includes complete accessories and features enabling precise installation of the system adjustment of the leaf (adjustment of the depth of the leaf hiding in the system, adjustment of the leaf position in relation to the frame - at the height +/- 2,5 mm) and a removable door stop enables replacing the leaf, a set of gaskets, guides, bearing rollers.

### ACCESSORIES INCLUDED IN THE PRICE

- Metal cassette
- Hook lock strike plate (optionally at extra charge)

### NOTES

- Norm PN EN 14351-2:2018-12. - door leaf.
- National Technical Assessment ITB-KOT-2020/1281 issue.1 - sliding system.
- System prepared for plasterboard walls with a thickness of 100 mm or 125 mm.
- Dimensions see table 7, page 212.

### EXTRA CHARGES

- Round or square pull
- Hook lock with pulls
- Hollow chipboard core

# TECHNICAL AND ENTRANCE DOORS

In this section we present products well known on investment projects.

We offer acoustic doors, specialized doors and also fire-resistant doors.

And the collection of entrance doors offers solid doors, protecting our homes and other areas that need special security and protection.



Products finished with CPL HQ and Gladstone / Halifax, which are marked with the AQUA STOP symbol have lower edge protection against humidity made with TechnoPORTA technology.



D23

D24

Acoustic 32 dB  
see page 150

# SUMMARY OF MODELS

## APARTMENT ENTRANCE DOORS

## AND TECHNICAL DOORS

Presented collections of models apply as:

### TECHNICAL DOORS

**Acoustic 27 dB, 32 dB, INNOVO 37 dB, Porta SILENCE 37 dB, EI 30, INNOVO 42 dB, 42 dB, PURE 57 dB, Fire-rated EI 30, EI 60**

### APARTMENT ENTRANCE DOORS

**AGATE, OPAL, EXTREME RC 2, QUARTZ, EXTREME RC 3, GRANITE cl. C**

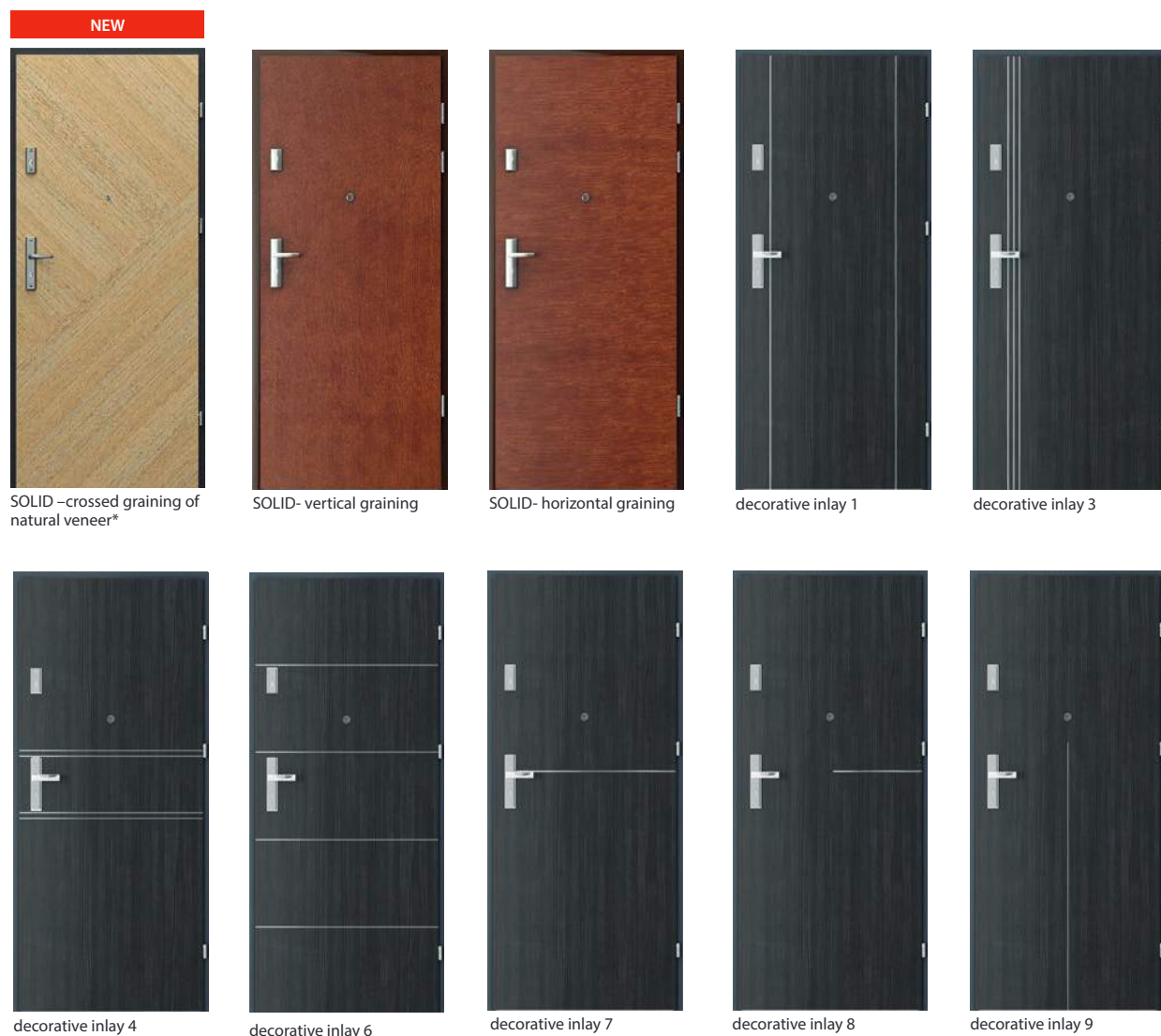

WITH DECORATIVE INLAYS: synthetic veneers - vertical graining, Gladstone/Halifax finish models 3, 6, 9 - graining direction - according to decorative inlays orientation

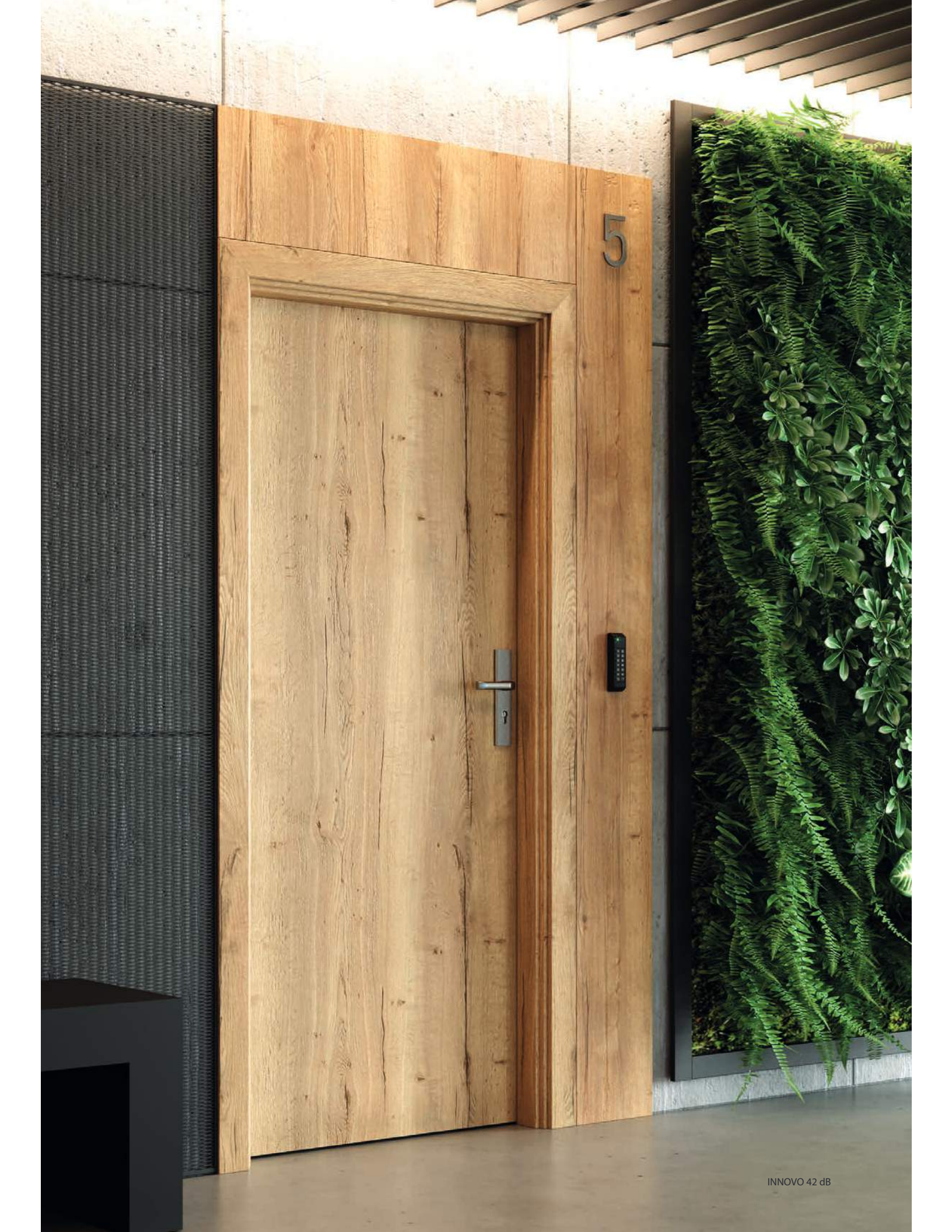

# Acoustic 27 dB, 32 dB

07



Acoustic 32 dB, White

Acoustic rating:  
Rw=31 dB\*  
Rw=35 dB\*

All available models -see page 148



Flush model, White

## ACOUSTIC RATING OF THE DOORS:

- Rw=27 dB (27–31 dB)
- Rw=32 dB (32–36 dB)



cylinder lock



automatic threshold seal



Three-part hinge



AQUA STOP

Rw 27dB  
D<sub>i</sub> 25

Rw 32dB  
D<sub>i</sub> 30

PROJECT

60 - 100

40-41 mm

44-45 mm

## AVAILABLE FINISHES

Natural Select ★★★★★  
Natural Oak, Ash, Walnut  
Natural Oak Satin

CPL HQ 0,2 mm ★★★★★

CPL HQ 0,7 mm ★★★★★  
Gladstone/Halifax

Finishes charts see page 250 – 257.

**NOTE!** Natural veneers (except Ash and Walnut) are available in vertical or horizontal grain direction (applies only to door leaf)

**NOTE!** It is recommended to choose CPL or Gladstone/Halifax laminate for entrance door, especially if they are used in public buildings.

27 dB, 32 dB

## TECHNICAL INFORMATION

### ACCESSORIES

- Three barrel hinges (adjustable door frame Porta system) or three-part hinges (steel door frame)
- Cylinder lock
- An automatic threshold seal
- A door frame seal
- A door frame
- A door leaf finished with CPL HQ or Gladstone/Halifax has liping ABS on the side edges.

### DOOR FRAMES

- Porta SYSTEM adjustable door frame (27dB door)
- Reinforced Porta SYSTEM adjustable door frame (32dB door),
- Corner steel door frame of 100mm wide profile
- PROJECT BIS, PROJECT PREMIUM door frame cover. 218).

### NOTES

- Technical Assessment ITB-KOT-2017/0096 issue 1 (Rw=27dB)
- Technical Assessment ITB-KOT-2017/0007 issue 1 (Rw=32dB)
- Acoustic rating Rw=27dB (27÷31 dB) D<sub>i</sub>=25 dB
- Acoustic rating Rw=32dB (32÷36 dB) D<sub>i</sub>=30dB
- Size '60' available for flush doors only (without decorative mouldings etc.)
- **Thanks so TechnoPORTA technology door leaves finished with CPL HQ and Gladstone / Halifax, have lower edges protected against humidity.**

### EXTRA CHARGES

- size '100'
- adjustable strike (steel door frame)
- door leaf: colours of CPL 0,2 mm and 0,7 mm veneers– GROUP II
- door frame: colours of CPL 0,2 mm veneer– GROUP II
- door leaf: Gladstone/Halifax colours with vertical grains
- inlays in synthetic veneers (for 1 side, for both sides – price x 2)
- inlays in natural veneers (for 1 side, for both sides – price x 2)
- door leaf: Natural veneer, White Oak, Satin
- door leaf: Natural veneer, Oak, Satin (other colours)
- door leaf: Natural veneer: Walnut
- door leaf: Natural veneer: Black
- door frame: Natural veneer, White Oak, Satin
- door frame: Natural veneer, Oak, Satin (other colours)
- door frame: Natural veneer: Walnut
- door leaf: model with crossed graining, Natural select veneer
- door leaf: model with crossed graining, Natural veneer Oak, Ash, Walnut
- steel door frame: colours - GROUP II
- steel door frame: colours - GROUP III
- steel door frame profile for PROJECT BIS cover
- steel door frame profile for PROJECT PREMIUM cover
- steel door frame profile from 101 to 150 mm
- steel door frame profile from 151 to 270 mm
- steel door frame profile from 271 to 390 mm
- steel door frame profile from 80 to 100 mm
- reinforcement for a door closer (steel door frame)
- reinforcement for a door closer (Porta SYSTEM door frame)
- reinforcement for a door closer - 27 dB door leaf
- 3 part hinges with Porta SYSTEM 27 dB door frame
- dowel pins (steel door frame)
- mounting anchors (steel door frame)
- a handle with an escutcheon

(see p. 224)

# INNOVO 37 dB

07



INNOVO 37 dB, Black

Acoustic rating:  
Rw=37 dB

All available models - see page 148



Solid with a steel door frame, Black

## ACOUSTIC RATING OF INNOVO 37 dB DOOR:

- Rw=37 dB (37-41 dB)



cylinder lock



automatic threshold seal



three part hinges

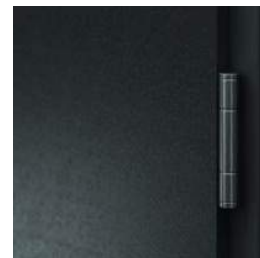

three part hinges



## ■ AVAILABLE FINISHES

CPL HQ 0,2 mm



CPL HQ 0,7 mm  
Gladstone/Halifax



Finishes charts see page 250 – 257.

INNOVO 37 dB

## ■ TECHNICAL INFORMATION

### DOOR LEAF CONSTRUCTION

INNOVO core is special 3-layered sound proofing construction with rails and stiles made of glued laminated softwood. The construction is skinned with HDF. Available in rebated option. Side edges finished with lipping ABS

### ACCESSORIES

- Two or three 3-part hinges
- Lock of the highest category of use - class 3 according to PN-EN 12209
- Automatic threshold seal

### DOOR FRAMES

- Porta SYSTEM adjustable door frame for a wall thickness range from 120 to 300 mm.
- Corner profile steel door frame of 100mm wide profile. Made of steel sheet, galvanized on both sides, 1,5 mm thick.

### NOTES

- Norm PN EN 14351-2; 2018-2.
- Fire rated doors should be equipped with escutcheon with a steel core handle. In case of using different hardware to offered by PORTA, guarantee cards guidelines must be followed.
- Available options: solid or with decorative inlays.
- Doors are equipped with a lock with a 9x9 mm spindle. Any of dedicated PORTA handle require metal spindle adapter 9/8.
- **Thanks to TechnoPORTA AQUA STOP technology door leaves finished with CPL HQ have lower edges protected against humidity.**

### EXTRA CHARGES

- size '100'
- door leaf: colours of CPL 0,2 mm and 0,7 mm veneers – GROUP II
- door frames: colours of CPL 0,2 mm veneer – GROUP II
- door leaf: Gladstone/Halifax colours with vertical grains
- inlays in synthetic veneers (for 1 side, for both sides – price x 2)
- steel door frame: colours - GROUP II
- steel door frame profile for PROJECT BIS cover
- steel door frame profile from 101 to 150 mm
- steel door frame profile from 151 to 270 mm
- steel door frame profile from 271 to 390 mm

# SILENCE 37 dB, EI 30

07

TOP  
COLLECTIONS



SILENCE, Oak Milano 5

Acoustic rating  $R_w=40$  dB\*  
Fire resistance 30 min.

All available models - see page 148



Solid, Oak Milano 5 with an adjustable door frame

## ACOUSTIC RATING OF PORTA SILENCE DOOR:

- $R_w=37$  dB (37-41 dB)



cylinder lock



heavy duty technical hinges



automatic threshold seal



## AVAILABLE FINISHES

Natural Select ★★★★★  
 Natural Oak, Ash, Walnut  
 Natural Oak Satin

CPL HQ 0,2 mm ★★★★★

CPL HQ 0,7 mm ★★★★★  
 Gladstone/Halifax

Finishes charts see page 250 – 257.

**NOTE!** Natural veneers (except Ash and Walnut) are available in vertical or horizontal grain direction (applies only to door leaf)

**NOTE!** It is recommended to choose CPL or Gladstone/Halifax laminate for entrance door, especially if they are used in public buildings.

SILENCE 37 dB

## TECHNICAL INFORMATION

### DOOR LEAF CONSTRUCTION

PortaSilence<sup>®</sup>core is a special 5-layered sound proofing construction with rails and stiles made of glued laminated softwood. The construction is skinned with HDF. Available in rebated and non-rebated options. A door leaf finished with CPL HQ or Gladstone/Halifax has liping ABS on the side edges.

### ACCESSORIES

- Two or three heavy duty technical hinges (Porta SYSTEM door frame and non-rebated versions) or three 3part hinges (rebated steel door frame)
- Rebated version of MDF door frame – 4 barrel hinges
- Lock of the highest category of use - class 3 according to PN-EN 12209
- Automatic threshold seal

### DOOR FRAMES

- A possibility of ordering a door frame in 2 options: rebated and non-rebated;
- Porta SYSTEM adjustable door frame for a wall thickness range from 120 to 300 mm. Made of plywood.
- Corner steel door frame of 100 mm wide profile. Made of steel sheet, galvanized on both sides, 1,5 mm thick.
- 100 mm MDF fixed door frame.
- PROJECT BIS, PROJECT PREMIUM (p.190)

### NOTES

- Technical Assessment ITB-KOT-2017/0007 issue 1.
- National certification of constancy of performance No 020-UWB-0567/W
- In order to meet the requirements of building law, regarding fire-rating and sound-proofness, it is necessary to use door closer.
- Fire rated doors should be equipped with escutcheon with a steel core handle
- In case of using different hardware to offered by PORTA, guarantee cards guidelines must be followed
- Available options: flat, or with decorative inlays.

- Fire rated doors – inlays available only in both sides option.
- Doors are equipped with a lock with a 9x9 mm spindle. Any of dedicated PORTA handle require metal spindle adapter 9/8.
- **Thanks to TechnoPORTA AQUA STOP technology door leaves finished with CPL HQ have lower edges protected against humidity.**

### EXTRA CHARGES

- size '100'
- door leaf: colours of CPL 0,2 mm and 0,7 mm veneers – GROUP II
- door frame: colours of CPL 0,2 mm veneer – GROUP II
- door leaf: Gladstone/Halifax colours with vertical grains
- inlays in synthetic veneers (for 1 side, for both sides – price x 2)
- inlays in natural veneers (for 1 side, for both sides – price x 2)
- door leaf: Natural Satin Oak White veneer
- door leaf: Natural Satin Oak veneer (other colours)
- door leaf: Natural Walnut veneer
- door leaf: Natural veneer Select Black
- door frame: Natural Satin Oak White veneer
- door frame: Natural Satin Oak veneer (other colours)
- door frame: Natural Walnut veneer
- door frame: Natural veneer Black
- steel door frame: polyester paint - GROUP II
- steel door frame: polyester paint - GROUP III
- steel door frame profile for PROJECT BIS cover
- steel door frame profile from 101 to 150 mm
- steel door frame profile from 151 to 270 mm
- steel door frame profile from 271 to 390 mm
- door leaf: model with crossed graining, Natural Select veneer
- door leaf: model with crossed graining, Natural veneer Oak, Ash, Walnut
- eye viewer
- handle with escutcheon

(see p. 224)

# INNOVO 42 dB

07



INNOVO 42 dB, Halifax Natural

Acoustic rating  
Rw=42 dB  
Fire-resistance EI 30  
Smoke control

all available models - see page 124



Solid with an adjustable door frame, Natural Halifax

## ACOUSTIC RATING:

- Rw=42 dB (42–46 dB)



cylinder lock



automatic threshold seals  
(option with MDF door frame)



heavy duty technical hinges

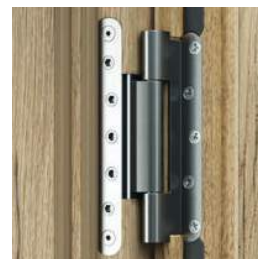

heavy duty technical hinges

## AVAILABLE FINISHES

CPL HQ 0,2 mm



CPL HQ 0,7 mm  
Gladstone/Halifax



\* does not apply to a set with Porta SYSTEM door frame

\*\* does not apply to a set with steel door frame and Porta SYSTEM idoor frame

Finishes charts see page 250 – 257.

INNOVO 42 dB

## TECHNICAL INFORMATION

### TECHNICAL INFORMATION

- Two heavy duty technical hinges - Porta SYSTEM door frame; three 3-part hinges - steel door frame, 4 hinges - MDF door frame
- Lock of the highest category of use - class 3 according to PN-EN 12209
- Automatic threshold seal
- Intumescent strip (under high temperatures) - EI 30 option

### DOOR FRAMES

- Reinforced adjustable Porta SYSTEM door frame . Door type DT-A42/PS for a wall thickness range from 120 to 300 mm. Door frame beams made from plywood.
- Corner profile steel door frame of 100 mm wide profile. Made from steel sheet 1,5 mm thick. Standard option includes reinforcement for a door closer
- MDF 100 mm fixed door frame equipped with hinge receivers with continuous 3D adjustment.
- It is possible to produce adjustable option of MDF frame for wall thickness from 160 mm - CONTRACT (bespoke) order.

### NOTES

- Product is available with Individual Approval Documentation
- Acoustic rating Rw=42 dB (range 42-46 dB)
- In order to meet the requirements of building law, regarding fire-rating and soundproofness, it is necessary to use a door closer.
- Door rails and stiles made of exotic or oak wood, colourless varnished or stained

- Fire rated doors should be equipped with an escutcheon with a steel spindle
- In case of using different hardware to offered by PORTA, guarantee cards guidelines must be followed
- Available only as solid option, with decorative inlays
- Doors are equipped with a lock with a 9x9 mm spindle. Any of thr dedicated PORTA handle require metal spindle adapter 9/8.
- **Thanks to TechnoPORTA AQUA STOP technology door leaves finished with CPL HQ have lower edges protected against humidity.**

### EXTRA CHARGES

- size '100'
- door leaf: CPL 0,2 mm and 0,7 mm veneers – GROUP II
- door frame: CPL 0,2 mm veneer – GROUP II
- decorative inlays for synthetic veneers (for 1 side, for both sides – the price x 2)
- steel door frame: polyester paint - GROUP II
- steel door frame: polyester paint - GROUP III
- steel door frame profile from 101 to 150 mm
- steel door frame profile from 151 to 270 mm
- steel door frame profile from 271 to 390 mm
- reinforcement for a door closer for Porta System frame
- reinforcement for a door closer for steel door frame

# Acoustic 42 dB

07



Acoustic 42 dB, Natural Walnut (matt)

Acoustic rating  
Rw=42 dB  
Fire-resistance EI 30

All available models - see page 148



Solid, Natural Walnut (matt)

## ACOUSTIC RATING:

- Rw=42 dB (42-46 dB)

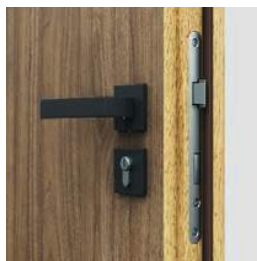

cylinder lock

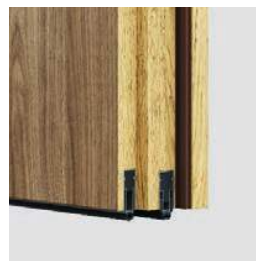

two automatic threshold seals  
(option with Porta System door frame)

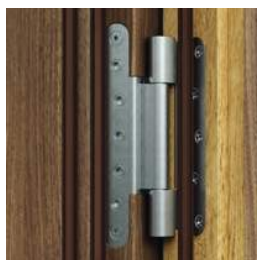

heavy duty technical hinges

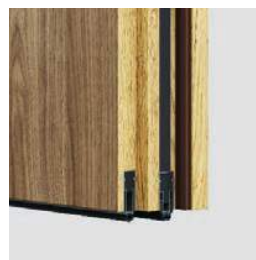

two automatic threshold seals  
(option with steel door frame  
and MDF door frame)





does not apply to a set with Porta SYSTEM door frame

## AVAILABLE FINISHES

Natural Select ★★★★★  
Natural Oak, Ash, Walnut  
Natural Oak Satin

CPL HQ 0,2 mm ★★★★★

CPL HQ 0,7 mm ★★★★★  
Gladstone/Halifax

Finishes charts see page 250 – 257.

**NOTE!** Natural veneers (except Ash and Walnut) are available in vertical or horizontal grain direction (applies only to door leaf)

**NOTE!** It is recommended to choose CPL or Gladstone/Halifax laminate for entrance door, especially if they are used in public buildings.

42 dB

## TECHNICAL INFORMATION

### ACCESSORIES

- Two heavy duty technical hinges, three hinges for MDF (EI 30) door frame
- Lock of the highest category of use - class 3 according to PN-EN 12209
- Two automatic threshold seals
  - rubber seal set circumferentially in door leaf and door frame rebates
  - intumescent strip (under high temperatures) - EI 30, Rw=42 dB option

### DOOR FRAMES

- Reinforced adjustable Porta SYSTEM door frame TYPE DT-AW/PS for a wall thickness range from 120 to 300 mm. Door frame beams made of plywood. Door set price shown on see p. 159 includes door frame of 'C' adjustment range.
- Corner profile steel door frame of 120 mm wide profile. Made of steel sheet 1,5 mm thick. Standard option includes reinforcement for a door closer.
- MDF fixed door frame equipped with hinge receivers with continuous 3D adjustment. It is possible to produce adjustable option of MDF frame for wall thickness from 160 mm - CONTRACT (bespoke) order.
- PROJECT BIS, PROJECT PREMIUM door frames (see p. 218).

### NOTES

- Technical Assessment ITB-KOT-2017/0096 issue 1.
- National certification of constancy of performance No 020-UWB-2546/W (does not apply to 42 dB set with Porta System door frame)
- Acoustic rating Rw=42 dB (range 42-46 dB)
- In order to meet the requirements of building law, regarding fire-rating and sound-proofness, it is necessary to use a door closer.
- Door rails and stile are made of exotic or oak wood and colourless varnished or stained
- Fire rated doors should be equipped with an escutcheon with a steel spindle
- In case of using different hardware to offered by PORTA, guarantee cards guidelines must be followed.

- Doors are equipped with a lock with a 9x9 mm spindle. Any of dedicated PORTA handle require metal spindle adapter 9/8.
- **Thanks to TechnoPORTA AQUA STOP technology door leaves finished with CPL HQ have lower edges protected against humidity.**

### EXTRA CHARGES

- size '100'
- door leaf: CPL 0,2 mm and 0,7 mm veneers – GROUP II
- door frame: CPL 0,2 mm veneer – GROUP II
- decorative inlays for synthetic veneers (for 1 side, for both sides – the price x 2)
- decorative inlays for natural veneers (for 1 side, for both sides – the price x 2)
- door leaf: Natural Satin Oak White veneer
- door leaf: Natural Satin Oak veneer (other colours)
- door leaf: Natural Walnut veneer
- door leaf: Natural Black veneer
- door frame: Natural Satin Oak White veneer
- door frame: Natural Satin Oak veneer (other colours)
- door frame: Natural Walnut veneer
- door frame: Natural Black veneer
- steel door frame: polyester paint- GROUP II
- steel door frame: polyester paint- GROUP III
- steel door frame profile for PROJECT BIS cover
- steel door frame profile for PROJECT PREMIUM cover
- steel door frame profile from 101 to 150 mm
- steel door frame profile from 151 to 270 mm
- steel door frame profile from 271 to 390 mm
- door leaf: model with crossed graining, Natural Select veneer
- door leaf: model with crossed graining, Natural veneer Oak, Ash, Walnut
- reinforcement for a door closer for Porta System frame
- eye viewer (EI 60)
- handle with an escutcheon

(see p. 224)

# PURE 57 dB

07



PURE, Natural Hickory

Acoustic rating  $R_w=57$  dB  
Fire-resistance EI 30  
Smoke control

All available models - see page 126



Solid with Porta SYSTEM door frame, Natural Hickory

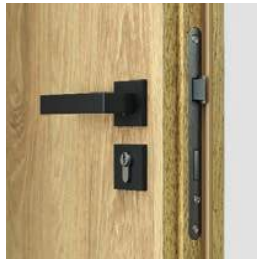

cylinder lock

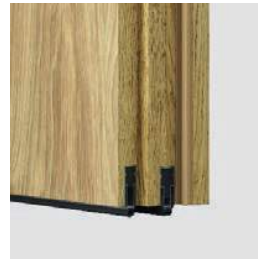

automatic threshold seals (option with Porta System door frame)



heavy duty technical hinges



automatic threshold seals (option with steel and MDF door frames)





## AVAILABLE FINISHES

CPL HQ 0,2 mm ★★★★★

CPL HQ 0,7 mm ★★★★★  
Gladstone/Halifax

Finishes charts see page 250 – 257.

PURE 57 dB

## TECHNICAL INFORMATION

### ACCESSORIES INCLUDED IN THE DOOR PRICE

- Two heavy duty technical hinges, three hinges for MDF (EI 30) door frame
- Lock of the highest category of use - class 3 according to PN-EN 12209
- Two automatic threshold seals
- rubber seal set circumferentially in door leaf and door frame rebates
- intumescent strip (under high temperatures) - EI 30, Rw=57 Db option

### DOOR FRAMES

- Two reinforced adjustable Porta System door frames TYPE DT-AW/PS - installed as a set in one wall opening. Adjustment range: 280-400 mm. Door frame beams are made from plywood.
- Two fixed MDF door frames, equipped with hinge receivers with continuous 3D adjustment. Installed as a set in one wall opening.
- Adjustment range 180-400 mm

### NOTES

- Product is available with Individual Approval Documentation
- Acoustic rating Rw=57 dB
- Acoustic rating obtained thanks to two 42 dB door leaves installed in one wall opening

- In order to meet the requirements of building law, regarding fire-rating and sound proofness, it is necessary to use a door closer.
- Door rails and stiles made of exotic or oak wood, colourless varnished or stained
- Fire rated doors should be equipped with an escutcheon with a steel spindle
- In case of using different hardware to offered by PORTA, guarantee cards guidelines must be followed
- Available only as solid option
- Doors are equipped with a lock with a 9x9 mm spindle. Any of the dedicated PORTA handles requires metal spindle adapter 9/8.
- **Thanks to TechnoPORTA AQUA STOP technology door leaves finished with CPL HQ have lower edges protected against humidity.**

### EXTRA CHARGES

- size '100'
- door leaf: CPL 0,2 mm and 0,7 mm veneers - GROUP II
- door frame: CPL 0,2 mm veneer – GROUP II
- reinforcement for a door closer for Porta System frame

# Fire-rated EI 30, EI 60

07



Fire-rated EI 30

EI 30  
Fire-resistance  
Acoustic rating  $R_w=34$  dB\*

EI 60  
Fire-resistance 60 min.  
Acoustic rating  $R_w=34$  dB\*

All available models -see page 148



Model 3, Brown Oak, MDF door frame

## ■ ACOUSTIC RATING OF EI 30 AND EI 60 DOORS:

- $R_w=32$  dB (32–36 dB)



flush (EI 30)



model 2 (EI 60)



model 3  
(EI 30, EI 30 soft)



examples of glazings  
bespoke orders (EI30)



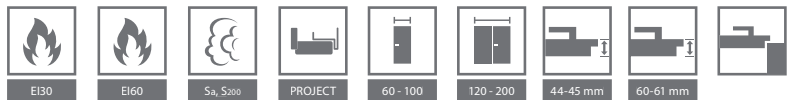

## AVAILABLE FINISHES

Natural Select ★★★★★  
 Natural Oak, Ash, Walnut  
 Natural Oak Satin

CPL HQ 0,2 mm ★★★★★

CPL HQ 0,7 mm ★★★★★  
 Gladstone/Halifax

Finishes charts see page 250 – 257.

**NOTE!** Natural veneers (except Ash and Walnut) are available in vertical or horizontal grain direction (applies only to door leaf)

**NOTE!** It is recommended to choose CPL or Gladstone/Halifax laminate for entrance door, especially if they are used in public buildings.

EI 30, EI 60

## TECHNICAL INFORMATION

### ACCESSORIES

- Hinges: Two or three (EI 30); four (EI 30 soft, EI 60)
- Cylinder lock
- Transparent, fire-resistant glass panel, (fixed width, not dependent on door leaf size)
- Intumescent strip (under high temperatures) - EI 30, Rw=42 dB option
- Automatic threshold seal
- A door leaf finished with CPL HQ or Gladstone/Halifax has liping ABS on the side edges.

### DOOR FRAMES

- MDF EI30 100 mm fixed door frame and adjustable one (min. 160 mm) (EI 30, EI 30 SOFT), equipped with adjustable hinges – heavy duty for EI 30 and adjustable barrel hinges for EI 30 SOFT
- Wooden door frame 120 mm (EI 60), made of three-ply glued softwood, equipped with adjustable barrel hinges
- Corner profile steel door frame, 100mm wide profile. Made from hot dip galvanized steel sheet 1,5 mm thick. Equipped with three-part hinges, dowels pins and reinforced for door closer.
- PROJECT BIS door frame (p.190).
- EI 30: PROJECT Premium door frame (p.190)
- EI 60: PROJECT Premium door frame. Available with Individual Approval Documentation. Ordering through Contract department, Details available in Investment Catalogue and at Sales Departments.

### NOTES

- EI 30 Technical Assessment ITB-KOT-2017/0007 issue 1. and National certification of constancy of performance No 020-UWB-0567/W
- EI 60 Technical Assessment ITB-KOT-2018/0407 issue 1. and National certification of constancy of performance No 020-UWB-2707/W
- In order to meet the requirements of building law, regarding fire-rating and sound-proofness, it is necessary to use a door closer.
- Fire rated doors should be equipped with an escutcheon with a steel spindle
- In case of using different hardware to offered by PORTA, guarantee cards guidelines must be followed

- Acoustic rating Rw=32 dB (32+36 dB)
- EI 60 in size '100' is not available in standard offer (Porta CONTRACT, see page 261).
- double EI 30 SOFT is not available.

### EXTRA CHARGES

- size '100' – EI 30
- double leaf door
- door leaf: CPL 0,2 mm and 0,7 mm veneers – GROUP II
- door frame: CPL 0,2 mm veneer – GROUP II
- door leaf: Gladstone/Halifax finish, vertical grain
- third hinge (MDF door frame)
- decorative inlays for synthetic veneers (for 1 side, for both sides – the price x 2)
- decorative inlays for natural veneers (for 1 side, for both sides – the price x 2)
- door leaf: Natural veneer, White Oak, Satin
- door leaf: Natural veneer, Oak, Satin (other colours)
- door leaf: Natural veneer: Walnut
- door leaf: Natural veneer: Black
- adjustable door frame: Natural veneer, White Oak, Satin
- door frame: Natural veneer, Oak, Satin (other colours)
- door frame: Natural veneer, Walnut
- door frame: Natural veneer, Black
- steel door frame: polyester paint - GROUP II
- steel door frame: polyester paint- GROUP III
- steel door frame profile for PROJECT BIS cover
- steel door frame profile EI 30 for PROJECT Premium cover
- steel door frame profile from 80 to 100 mm
- steel door frame profile from 101 to 150 mm
- steel door frame profile from 151 to 270 mm
- steel door frame profile from 271 to 390 mm
- door leaf: model with crossed graining, Natural Select veneer
- door leaf: model with crossed graining, Natural veneer Oak, Ash, Walnut
- oor viewer (EI 60)
- quarter rounds, architraves (see p. 237)
- handle with an escutcheon (see p. 224)

# ENDURO

07



Interior technical doors with the highest durability, abrasion resistance class and resistance to various external conditions. Specially profiled edge guards made of stainless steel and. Finish - extremely durable HPL or CPL veneer.

ENDURO, Anthracite



ENDURO 3, Anthracite



solid



model 1



model 2



model 3



model 4



## AVAILABLE FINISHES

HPL, CPL 0,7 veneer ★★★★★★

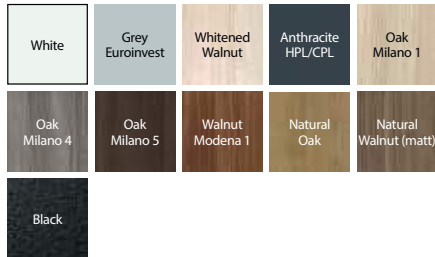

### ENDURO - INDICATIONS FOR USE

- Laboratories
- Dental clinics
- Hospitals



push panel



kick panel



ventilation kick panel



ventilation grille

ENDURO

## TECHNICAL INFORMATION

### ACCESSORIES

- Rebated option: reinforced three-part hinges (3 PCs)
- Swinging option: two (size '60'), three ('70', '80'), or four ('90') hinges

### Transparent or frosted, tempered glass panel, (model 4 - laminated glass panel)

- Lock: key lock, WC lock, or cylinder lock
- Reinforcement for a door closer included

### DOOR FRAMES

- Corner profile steel door frame, profile: 105 mm wide. Made from galvanized steel sheet 1,2 mm thick. Equipped with 3 PCs of reinforced three-part hinges (which come with door leaf), rubber seal set circumferentially, six dowel pins. Powder coated (finishes charts see p. 221).
- Option of ordering two types of a door frame:
  - to install on finished floor level - '0'
  - to install below a floor level - '-30'

### NOTES

- Technical Assessment AT-15-6515/2016 Warsaw, for swinging doors ITB-KOT-2017/0184 issue 1
- New installation method of edge guards - without interference with veneer structure
- Maximum size of a swinging door leaf - '90'

### EXTRA CHARGES

- size '100'
- adjustable strike plate
- steel door frame: polyester paint GROUP II
- steel door frame: polyester paint GROUP III
- door frame profile from 80 to 100 mm
- door frame profile 106 to 150 mm
- door frame profile 155 to 270 mm
- door frame profile 275 to 390 mm
- push panel - both sides set
- kick panel both sides set
- ventilation kick panel - both sides set
- stainless steel ventilation grille
- swinging option
- handle with an escutcheon

(see p. 224)

# Strength performance Class 4

07



Strength performance Class 4, Anthracite, Edel handle

Included in the door set price

- door leaf
- door frame



Strength performance Class 4, Anthracite, Edel handle



reinforced three-piece hinge



lock with the top 3rd class of use category acc. to PN-EN 12209



## COLOURING

Natural Select ★★★★★  
 Natural Oak, Ash veneer, Walnut  
 Natural Satin Oak

CPL HQ 0.2 mm ★★★★★

CPL HQ 0.7 mm ★★★★★  
 Gladstone/Halifax

**NOTE!** Natural veneers (except Natural Veneer Ash and Walnut) can be made in vertical or horizontal grain direction (applies to door leaf).

**NOTE!** It is recommended to choose CPL or Gladstone/Halifax laminate for entrance door, especially if they are used in public building

For colour samples, see page 250 – 257.

## TECHNICAL INFORMATION

### DOOR LEAF DESIGN

The filling of the leaf is a hollow chipboard core or solid chipboard core (option at extra charge) reinforced with an internal stile.  
 The whole is covered with HDF board (synthetic veneer) or chipboard (natural veneer).  
 Available in a rebated version.

### ACCESSORIES

- Two or three three-part hinges in technical spacing
- Lock with the top 3rd class of use category acc. to PN-EN 12209

### DOOR FRAMES

Made of steel sheet galvanized on both sides, of thickness 1.5 mm:

- Steel Angle LARGE,
- Steel Adjustable,
- Steel PORTA SYSTEM.

### NOTES

- Standard PN-EN 14351-2.
- Steel panels available in "80", "90" and "100" sizes for CPL finish.
- Available only in the flat version.
- Door leaf adapted to installation of door closer.
- Product available in investment standard only.

### EXTRA CHARGES

- door frame: polyester paint - GROUP II
- door frame: polyester paint - GROUP III
- bottom panel - set for two sides (CPL veneer)
- ventilation bottom panel - set for both sides (CPL veneer)
- bottom panel with ventilation undercut - set for both sides (CPL veneer)
- top panel - set for both sides (CPL veneer)
- undercut, sleeves
- size "100"
- door leaf: Gladstone/Halifax colours in vertical layout
- door leaf: veneer CPL 0.2 mm and 0.7 mm - GROUP II
- door leaf: veneer Nat. Select Black
- door leaf: veneer Nat. Satin Oak White
- door leaf: model with a mixed veneer layout Nat. Select
- door leaf: model with a mixed veneer layout Nat. Oak, Ash, Walnut
- change from hollow chipboard core to solid chipboard core (synthetic veneer)
- handle with escutcheon

(p. 224)

# AQUA

07



Thanks to the construction Aqua doors can be installed in business premises e.g. wellness centres, eating places.

AQUA 4, Grey

The price of a door set includes

- door leaf
- door frame



AQUA 4, Grey



solid

model 1

model 2





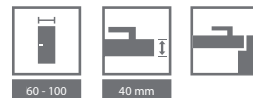

## AVAILABLE FINISHES

### Okleina HPL ★★★★★



### AQUA - INDICATIONS FOR USE:

- Eating places
- Shops
- Business premises
- Wellness centres
- Beauty parlours



door leaf cross-section

AQUA

## TECHNICAL INFORMATION

### ACCESSORIES

- Two stainless steel hinges
- Transparent or frosted, tempered glass panel, (model 4 - laminated glass panel)
- Lock: key lock, WC lock, or cylinder lock
- A door frame

### DOOR FRAMES

- Corner profile steel door frame - LARGE, profile: 105 mm wide. Made from galvanized steel sheet 1,2 mm thick. Equipped with two hinges (which come with door leaf), rubber seal, set circumferentially, six dowel pins. Powder coated (finishes charts see p. 257).
- Option of ordering two types of a door frame:
  - to install on finished floor level - '0'
  - to install below a floor level - '-30'

### NOTES

- Technical Assessment ITB-KOT-2017/0006 issue 1
- Door closer can be used

### EXTRA CHARGES

- size '100'
- stainless steel ventilation grille
- steel door frame: polyester paint - GROUP II
- teal door frame: polyester paint - GROUP III
- door frame profile from 80 to 100 mm
- door frame profile 106 to 150 mm
- door frame profile 155 to 270 mm
- door frame profile 275 to 390 mm
- **K** reinforcement for a door closer - door frame
- handle with an escutcheon

(see p. 261)  
(see p. 232)

# ENTRANCE DOORS

In the front entrance door section, we offer products that are well-known to estate developers. The collection of entrance doors consists of solid doors protecting our apartments and other premises that require special protection and security.



Products finished with CPL HQ or Gladstone/Halifax veneer and marked with AQUA STOP symbol offer protection of the bottom edge against moisture with the TechnoPORTA technology.

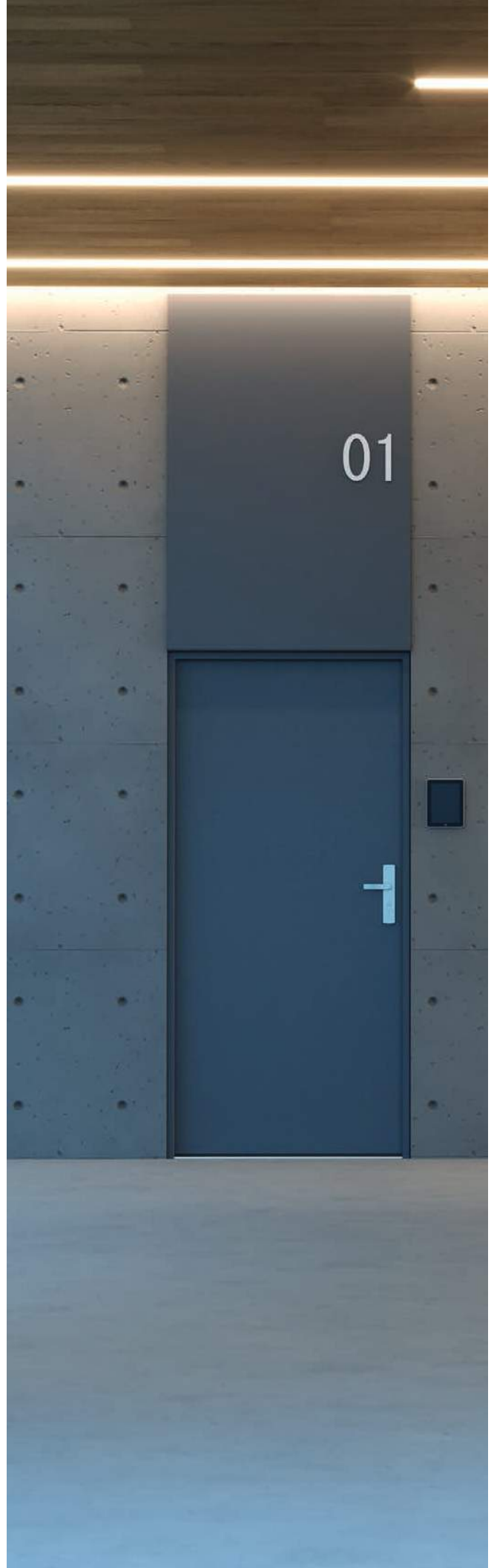



# AGATE

apartment entrance doors 32 dB

# OPAL

anti-burglary doors RC 2, 32 dB

08



AGATE Solid, Sand Beech with a steel door frame

Burglar resistance RC2 (Opal)  
Acoustic rating Rw=32dB

All available models - see page 148



Solid AGATE, Sand Beech, with a steel door frame

## OPAL DOOR

Doors with burglar resistance class RC2 according to PN EN 1627:2012 OPAL are also acoustic rated Rw=32 dB (32-36 dB). Opal remain burglar-resistant only as a part of a complete set: steel door frame (suggested by Porta), stainless steel threshold, a handle with an escutcheon (at least 2 class) and a cylinder (at least 4th class of burglary resistance).

## AGATE DOOR

Reinforced Agate door is equipped with locks with security pins. It is acoustic rated Rw=32 dB (32-36 dB).



a lock with security pins - AGATE



dog bolts - AGATE, OPAL

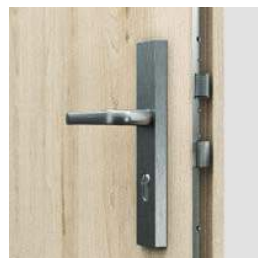

4 point lock - OPAL



adjustable strike - steel door frame (optionally)



## AVAILABLE FINISHES

Portasynchro 3D	★★★
Natural Select Natural Oak, Ash, Walnut Natural Oak Satin	★★★★
Portaperfect 3D CPL HQ 0,2 mm	★★★★★
CPL HQ 0,7 mm Gladstone/Halifax	★★★★★

Finishes charts see page 250 – 257.

**NOTE!** Natural veneers (except Ash and Walnut) are available in vertical or horizontal grain direction (applies only to door leaf)

**NOTE!** It is recommended to choose CPL or Gladstone/Halifax laminate for entrance door, especially if they are used in public buildings.



 How to install OPAL doors- see video  
[www.porta.com.pl/dm/montazopal.wm](http://www.porta.com.pl/dm/montazopal.wm)

Doorset price:  
door leaf+door frame+steel threshold+door viewer  
(at extra charge).

### WE RECOMMEND!

THANKS TO THE ALUMINIUM LAYER, DOORS ARE EXCEPTIONALLY RESISTANT TO ADVERSE CONDITIONS OF USE, TEMPERATURE AND HUMIDITY DIFFERENCES, WHICH ARE COMMON IN COMMUNAL AREAS.



## TECHNICAL INFORMATION

### DOOR LEAF CONSTRUCTION

Door leaf frame is made of glued laminated softwood. It is reinforced with stiles. Door leaf is skinned with a layer of aluminium sheet and wood-based board. Door leaves with silver decorative inlays are available. Natural veneers are finished with semi-matt varnish. A door leaf finished with CPL HQ or Gladstone/Halifax has lipping ABS on the side edges.

### ACCESSORIES INCLUDED IN THE AGAT DOOR PRICE

- One or two locks with security pins
- Three barrel hinges
- Three dog bolts - NEW
- Door frame equipped with a standard stainless steel threshold (90 mm)

### ACCESSORIES INCLUDED IN OPAL DOOR PRICE

- 4 point lock - for two cylinders
- Three barrel hinges (steel door frame)
- Three dog bolts
- Steel door frame equipped with stainless steel threshold (90 mm)

### DOOR FRAMES

- Corner profile steel door frame, profile 105 mm wide. Made from both sides galvanized steel sheet 1,2 mm thick (AGATE) or 1,5 mm thick (OPAL).
- Equipped with three barrel hinges, rubber seal set circumferentially. OPAL is additionally equipped with six dowel pins.
- PROJECT BIS, PROJECT PREMIUM door frames (see p. 218).

### NOTES

- Technical Assessment ITB-KOT-2017/0096 issue 1.
- Preparation for shortening (maximum 60 mm)
- Acoustic rating  $R_w=32$  dB (32÷36 dB)
- Threshold is a part of steel AGATE/OPAL door frame

### EXTRA CHARGES

- door viewer
- size '100'
- adjustable lock strike plate (steel door frame)
- door frame: CPL 0,2 mm veneer – GROUP II
- door leaf: CPL 0,2 mm and 0,7 mm veneers – GROUP II
- door leaf: Gladstone/Halifax finish, vertical graining
- white or black glass applique (for solid models)
- decorative inlays for synthetic veneers (for 1 side, for both sides – the price x 2)
- decorative inlays for natural veneers (for 1 side, for both sides – the price x 2)
- door leaf: Natural veneer, White Oak, Satin
- door leaf: Natural veneer, Oak, Satin (other colours)
- door leaf: Natural veneer: Walnut
- door leaf: Natural veneer: Black
- adjustable door frame: Natural veneer, White Oak, Satin
- door frame: Natural veneer, Oak, Satin (other colours)
- door frame: Natural veneer, Walnut
- door frame: Natural veneer, Select Black
- 6 dowel pins - AGATE door frame
- steel door frame: polyester paint GROUP II
- steel door frame: polyester paint GROUP III
- steel door frame: black
- door leaf: model with crossed graining, Natural Select veneer
- door leaf: model with crossed graining, Natural veneer Oak, Ash, Walnut
- steel door frame profile for PROJECT BIS cover
- steel door frame profile for PROJECT PREMIUM cover
- steel door frame profile from 106 to 150 mm
- steel door frame profile from 151 to 270 mm
- steel door frame profile from 271 to 390 mm
- reinforcement for a door closer for a steel door frame
- cylinder inserts
- a handle with an escutcheon

(see p. 232)

# EXTREME RC 2

anti-burglary doors, class RC 2, 37 dB

08



EXTREME RC2, Solid, Oak Milano 1 with a steel door frame

Burglar resistance RC2  
Acoustic rating  $R_w = 37 \text{ dB}^*$

All available models - see page 148

The price of a door set includes

- door leaf
- frame
- stainless steel threshold

## EXTREME RC 2 doors

Extreme RC2 doors are equipped with 2 locks with 3 security pins, cylinders of class B and dog bolts.

The are:

- burglar resistant - class RC2 according to PN EN 1627:2012
- acoustic rated  $R_w=37 \text{ dB}$  (37-41 dB)



EXTREME RC2, Oak Milano 1 with a steel door frame



lower lock - 3 security pins



upper lock - 3 security pins



dog bolts



3 PCs of three-part hinges



adjustable lock strike (optional) - steel door frame



stainless steel threshold (90 mm)

## AVAILABLE FINISHES

Natural Select ★★★★★  
Natural Oak, Ash, Walnut  
Natural Oak Satin

CPL HQ 0,2 mm ★★★★★

CPL HQ 0,7 mm ★★★★★  
Gladstone/Halifax

**NOTE!** Natural veneers (except Ash and Walnut) are available in vertical or horizontal grain direction (applies only to door leaf).

**NOTE!** It is recommended to choose CPL or Gladstone/Halifax laminate for entrance door, especially if they are used in public buildings.

Finishes charts see page 250 – 257.

### WE RECOMMEND!

THANKS TO THE ALUMINIUM LAYER, RC 2 DOORS ARE EXCEPTIONALLY RESISTANT TO ADVERSE CONDITIONS OF USE, TEMPERATURE AND HUMIDITY DIFFERENCES, WHICH ARE COMMON IN COMMUNAL AREAS.



## TECHNICAL INFORMATION

### DOOR LEAF CONSTRUCTION

Core: special, 5-layer construction with rails and stiles made of glued laminated softwood, skinned with HDF. Available in rebated option.

A door leaf finished with CPL HQ or Gladstone/Halifax has lipping ABS on the side edges.

### ACCESSORIES INCLUDED IN THE DOOR PRICE

- Two locks with security pins (handle spacing 72 mm)
- Silver three-part hinges (3 PCs)
- Four dog bolts
- A door frame
- Standard stainless steel threshold (90 mm)

### DOOR FRAMES

- Corner profile steel door frame, profile 100 mm wide. Made from both sides galvanized steel sheet 1,5 mm thick.
- Equipped with three three-part hinges, rubber seal set circumferentially and eight dowel pins.
- PROJECT BIS door frame see p. 218.

### NOTES

- Norm PN-EN 14351-2-2018-12
- Acoustic rating  $R_w=37$  dB (37±41 dB)

- Door leaf and door frame are adapted for a door closer
- **Thanks to TechnoPORTA AQUA STOP technology door leaves finished with CPL HQ have lower edges protected against humidity.**

### EXTRA CHARGES

- size '100'
- adjustable lock strike (steel door frame)
- door leaf: CPL 0,2 mm and 0,7 mm veneers – GROUP II
- door leaf: Gladstone/Halifax finish, vertical graining
- decorative inlays for synthetic veneers (for 1 side, for both sides – the price x 2)
- decorative inlays for natural veneers (for 1 side, for both sides – the price x 2)
- door leaf: Natural veneer, White Oak, Satin
- door leaf: Natural veneer, Oak, Satin (other colours)
- door leaf: Natural veneer: Walnut
- door leaf: Natural veneer: Black
- steel door frame: polyester paint - GROUP II
- steel door frame: polyester paint - GROUP III
- steel door frame profile for PROJECT BIS cover
- steel door frame profile from 106 to 150 mm
- steel door frame profile from 151 to 270 mm
- steel door frame profile from 271 to 390 mm
- door leaf: model with crossed graining, Natural Select veneer
- door leaf: model with crossed graining, Natural veneer Oak, Ash, Walnut
- panoramic door viewer
- door viewer
- a handle with escutcheon

(see p. 232)

# Steel SECURE

anti-burglary doors, class RC 3, EI 30, 37 dB

08



Steel SECURE A.0 with a door viewer, Structured Black

Burglar resistance RC 3  
Acoustic rating  $R_w=37$  dB  
Fire resistance EI 30

#### Included in the price

- door leaf
- frame
- steel threshold
- handle
- euro cylinder

#### Option at extra cost:

- additional top lock

#### PROTECTION SYSTEM OF STEEL SURFACES

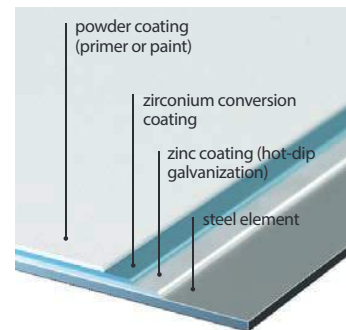

#### Steel SECURE doors

Doors are equipped with multipoint lock and two cylinders class C. They have: RC3 class according to PN EN 1627:2012  
Acoustic rating  $R_w=37$ dB (37-41 dB)  
Fire resistance EI 30

**P**  
GALVANIZED SHEET  
PORTASTEEL PRODUCT

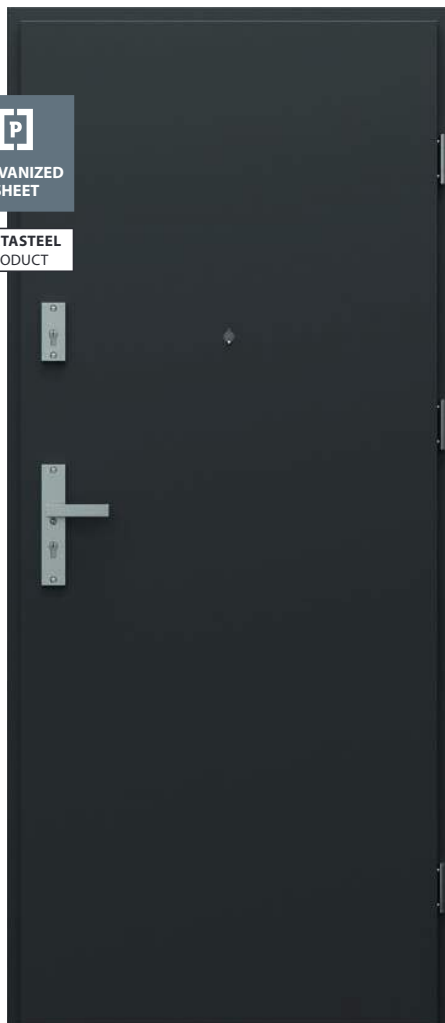

Steel SECURE A.0 with a door viewer, Structured Black



multipoint lock with two cylinders



dog bolt



reinforced 3part hinge





## AVAILABLE FINISHES

### Polyester Premium Paint ★★★★★☆

GROUP I	White MAT	Structured anthracite
	GROUP II	
	Structured Black	

### Laminated steel sheet (PVC) ★★★★★☆

Golden Oak	Oak Winchester	Walnut	Anthracite
---------------	-------------------	--------	------------



spring loaded door closer



spring loaded door closer



hook

Steel SECURE

## TECHNICAL INFORMATION

### DOOR LEAF CONSTRUCTION

The construction is based on double layer wooden rails and stiles. The core is multilayer, based on mineral wool. The construction is skinned with galvanized steel sheet 0,6 mm - film laminated (PVC) or coated with a polyester paint.

### ACCESSORIES INCLUDED DOOR PRICE

- Three-part hinges (3 PCs)
- WINKHAUS STV multipoint lock
- Four dog bolts
- 'SECURE' handle
- Cylinders class C
- Reinforcement for a door closer (door leaf and door frame)
- Stainless steel threshold with a perforation

### DOOR FRAMES

- Corner profile steel door frame, profile 100mm wide. Made from, both sides galvanized steel sheet 1,5 mm thick.

### NOTES

- Norm PN-EN 14351-2:2018-12, Norm PN-EN 16034:2014-11.

### EXTRA CHARGES

- size '100'
- additional upper lock
- upper escutcheon
- door viewer
- upper cylinder
- spring loaded door closer
- polyester paint - group II

# QUARTZ

anti-burglary doors, class RC 2 (type III), EI 30, 32 dB

08



QUARTZ, decorative inlays 6, with a steel door frame

Burglary resistance class RC 2  
(type III)  
Acoustic rating  $R_w=34$  dB\*  
Fire-resistance EI 30

All available models - see page 148

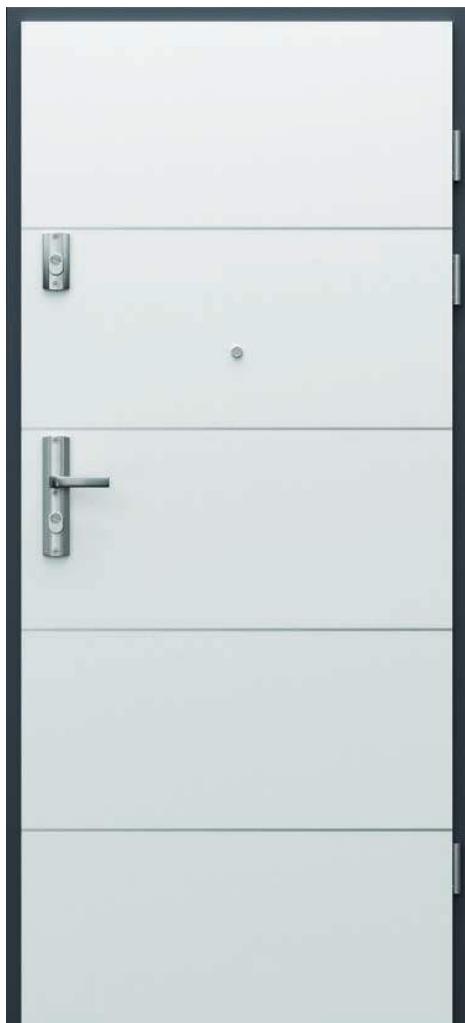

QUARTZ, decorative inlays 6, with a steel door frame

## QUARTZ doors

DT-PP-DY/M (QUARTZ type I and type II) doors are equipped with one or two cylinder locks.

- They have following qualities:
- acoustic rating  $R_w=32$  dB (32-36 dB)
- fire resistance EI 30
- smoke control

DT-K32 (QUARTZ type III) doors are equipped with a multipoint lock and dog bolts.

- They have following qualities:
- burglar resistance - class RC 2 according to PN EN 1627:2012
- acoustic rating  $R_w=32$  dB (32-36 dB)
- fire resistance EI 30
- smoke control



Four point lock with two cylinders - QUARTZ III



dog bolts - QUARTZ III



reinforced three-part hinge



## AVAILABLE FINISHES

Portasynchro 3D	★★★
Natural Select Natural Oak, Ash, Walnut Natural Oak Satin	★★★★
Portaperfect 3D CPL HQ 0,2 mm	★★★★★
CPL HQ 0,7 mm Gladstone/Halifax	★★★★★

**NOTE!** Natural veneers (except Ash and Walnut) are available in vertical or horizontal grain direction (applies only to door leaf)

**NOTE!** It is recommended to choose CPL or Gladstone/Halifax laminate for entrance door, especially if they are used in public buildings.

Finishes charts see page 250 – 257.

### WE RECOMMEND!

THANKS TO THE ALUMINIUM LAYER, QUARTZ DOORS ARE EXCEPTIONALLY RESISTANT TO ADVERSE CONDITIONS OF USE, TEMPERATURE AND HUMIDITY DIFFERENCES, WHICH ARE COMMON IN COMMUNAL AREAS.



## TECHNICAL INFORMATION

### DOOR LEAF CONSTRUCTION

Core: Multilayer construction which provides fire-resistance of 30 min and acoustic insulation of  $R_w=34dB^*$ . Thanks to a layer of aluminium sheet door leaves are extremely resistant to adverse conditions of use that are characteristic for communal areas. A door leaf finished with CPL HQ or Gladstone/Halifax has lipping ABS on the side edges.

### ACCESSORIES INCLUDED IN DOOR PRICE

- A mortise cylinder lock with a rectangular deadbolt and (QUARTZ Type I)
- Two cylinder mortise locks with rectangular deadbolts (QUARTZ Type II)
- A 4-point lock with two cylinders and three dog bolts (QUARTZ Type III)
- Reinforced, silver three-part hinges (3 PCs)
- An intumescent seal in a door leaf rebate
- A door frame with a standard stainless steel threshold (90 mm)

### DOOR FRAMES

- Corner profile steel door frame, profile 105mm wide. Made from both sides galvanized steel sheet 1,5 mm thick. Equipped with self-extinguishing gasket, three 3-part hinges, stainless steel threshold - standard 90 mm, reinforcement for a door closer. QUARTZ I has one lock strike, QUARTZ II - two lock strikes, QUARTZ III multipoint lock strike, six dowel pins and receivers for dog bolts.
- PROJECT BIS, PROJECT Premium door frames (p.190)

### NOTES

- Technical Assessment ITB-KOT-2017/0007 issue 1.
- National certification of constancy of performance No 020-UWB-0567/W
- In order to meet the requirements of building law, regarding fire-rating and/or smoke control, it is necessary to use a door closer.
- In case of using different hardware to offered by PORTA, guarantee cards guidelines must be followed.
- Fire rated doors should be equipped with an escutcheon and a handle with a steel spindle
- Acoustic rating  $R_w=32\text{ dB}$  (32-36 dB)

### EXTRA CHARGES

- door viewer
- size '100'
- door leaf: CPL 0,2 mm and 0,7 mm veneers – GROUP II
- door leaf: Gladstone/Halifax finish, vertical graining
- decorative inlays for synthetic veneers (for 1 side, for both sides – the price x 2)
- decorative inlays for natural veneers (for 1 side, for both sides – the price x 2)
- door leaf: Natural veneer, White Oak, Satin
- door leaf: Natural veneer, Oak, Satin (other colours)
- door leaf: Natural veneer, Walnut
- door leaf: Natural veneer, Select Black
- steel door frame: polyester paint- GROUP II
- steel door frame: polyester paint- GROUP III
- steel door frame profile for PROJECT BIS cover
- steel door frame profile for PROJECT PREMIUM cover
- steel door frame profile from 101 to 150 mm
- steel door frame profile from 151 to 270 mm
- steel door frame profile from 271 to 390 mm
- door leaf: model with crossed graining, Natural Select veneer
- door leaf: model with crossed graining, Natural veneer Oak, Ash, Walnut
- a handle with an escutcheon

(see p.232)

# EXTREME RC 3

anti-burglary doors, class RC 3, EI 30, 37 dB

08



Burglary resistance class RC 3  
Acoustic rating  $R_w=40$  dB\*  
Fire-resistance EI 30  
Smoke control

EXTREME RC 3, Sand Oak with a reinforced PS door frame (bespoke solution Porta CONTRACT, see p. 226)

All available models - see page 148



#### Included in the price

- door leaf
- frame
- steel threshold
- handle
- euro cylinder

#### Option at extra cost:

- additional top lock

#### we offer two types:

##### Type I

- RC 3 burglary resistance class according to PN EN 1627-2012
- Acoustic rating  $R_w=37$  dB (37-41 dB)
- smoke control

##### Type II

- Type I qualities
- fire-resistance EI 30



2 anti-burglary hooks



Winkhaus multipoint lock with hooks

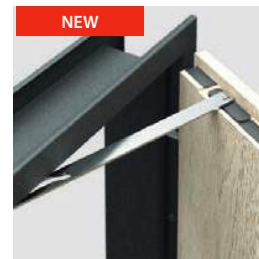

Spring loaded door closer with a steel door frame



4 dog bolts intumescent seal (Type II)



Porta SYSTEM door frame



EXTREME RC3, Sand Oak with a reinforced PS door frame

Detailed tests results are available on our website tab DOWNLOAD on [www.porta.com.pl](http://www.porta.com.pl)

DETAILED OFFER IS ALSO AVAILABLE ON [www.portadoors.com](http://www.portadoors.com)

## AVAILABLE FINISHES

Natural Select ★★★★★  
Natural Oak, Ash, Walnut  
Natural Oak Satin

CPL HQ 0,2 mm ★★★★★

CPL HQ 0,7 mm ★★★★★  
Gladstone/Halifax

**NOTE!** Natural veneers (except Ash and Walnut) are available in vertical or horizontal grain direction (applies only to door leaf)

**NOTE!** It is recommended to choose CPL or Gladstone/Halifax laminate for entrance door, especially if they are used in public buildings.

Finishes charts see page 250 – 257.

### WE RECOMMEND!

THANKS TO THE ALUMINIUM LAYER, EXTREME DOORS ARE EXCEPTIONALLY RESISTANT TO ADVERSE CONDITIONS OF USE, TEMPERATURE AND HUMIDITY DIFFERENCES, WHICH ARE COMMON IN COMMUNAL AREAS.



## TECHNICAL INFORMATION

### DOOR LEAF CONSTRUCTION

Core: special 5-layer construction with rails and stiles made of glued laminated softwood, skinned with HDF. Available in rebated option.  
A door leaf finished with CPL HQ or Gladstone/Halifax has lipping ABS on the side edges.

### ACCESSORIES INCLUDED IN THE DOOR LEAF PRICE

- Winkhaus STV hook lock with a pressure adjustment and an additional upper lock
- Two anti-burglary cylinders
- A handle with an anti-burglary escutcheon, 'SAFE'
- An upper escutcheon, 'SAFE'
- 3 PCs of three-part hinges (steel door frame) or 2 PCs of heavy duty hinges (reinforced PS frame). Both options - silver.
- Four dog bolts
- Additionally: type II - high temperature intumescent seal on door leaf edges (apart from bottom edge)
- Door frame is equipped with a standard stainless steel threshold (90 mm) and reinforcement for a door closer

### DOOR FRAMES

- Corner profile steel door frame, profile 100mm wide. Made from both sides galvanized steel sheet 1,5 mm thick. Equipped with self-adhesive gasket, eight dowel pins and a stainless steel threshold (120 mm).
- Reinforced Porta system door frame with an adjustment range 120-300 mm. Architraves 80 mm wide
- PROJECT BIS door frame (see p. 218).
- Modified PROJECT door frame, order processing: PORTA contracts department. Details available in Investment Catalogue and at Sales Departments.

### NOTES

- Technical Assessment ITB-KOT-2017/0007 issue 1.
- National certification of constancy of performance No 020-UWB-0567/W
- In order to meet the requirements of building law, regarding fire-rating and/or smoke control, it is necessary to use a door closer.
- Fire rated doors should be equipped with an escutcheon and a handle with a steel spindle.

- In case of using different hardware to offered by PORTA, guarantee cards guidelines must be followed.
- A fire-rated door - decorative inlays are available only as an option for both sides
- **Thanks to TechnoPORTA AQUA STOP technology door leaves finished with CPL HQ have lower edges protected against humidity.**

### EXTRA CHARGES

- door viewer
- panoramic door viewer
- size '100'
- spring loaded door closer
- door leaf: CPL 0,2 mm and 0,7 mm veneers – GROUP II
- door frame: CPL 0,2 mm veneer - GROUP II
- door leaf: Gladstone/Halifax finish, vertical graining
- decorative inlays for synthetic veneers (for 1 side, for both sides – the price x 2)
- decorative inlays for natural veneers (for 1 side, for both sides – the price x 2)
- door leaf: Natural veneer, White Oak, Satin
- door leaf: Natural veneer, Oak, Satin (other colours)
- door leaf: Natural veneer, Walnut
- door leaf: Natural veneer, Select Black
- door frame: Natural veneer, White Oak, Satin
- door frame: Natural veneer, Oak, Satin (other colours)
- door frame: Natural veneer: Walnut
- door frame: Natural veneer: Select Black
- steel door frame: polyester paint - GROUP II
- steel door frame: polyester paint - GROUP III
- steel door frame profile for PROJECT BIS cover
- steel door frame profile for PROJECT Premium cover
- steel door frame profile from 101 to 150 mm
- steel door frame profile from 151 to 270 mm
- steel door frame profile from 271 to 390 mm
- door leaf: model with crossed graining, Natural Select veneer
- door leaf: model with crossed graining, Natural veneer Oak, Ash, Walnut
- a handle with an escutcheon, 'SAFE'

(see p. 232)

# EXTREME RC 4

anti-burglary doors, class RC 4, EI 30, 37 dB

08



EXTREME RC 4, Anthracite

Burglary resistance class RC 4  
Acoustic rating  $R_w=37$ dB  
Fire-resistance EI 30  
Smoke control

All available models - see page 148



EXTREME RC 4, Anthracite

Included in the price

- door leaf
- frame
- steel threshold
- handle
- euro cylinder

Option at extra cost:

- additional top lock

## EXTREME RC4 doors

we offer two types:

### Type I

- RC4 burglary resistance class according to PN EN 1627-2012
- Acoustic rating  $R_w=37$  dB (37–41 dB)\*
- smoke control

### Type II

- Type I qualities
- fire-resistance EI 30



dedicated handle and multipoint lock



interlocking hooks



reinforced object hinges



lock hook movable catches



stainless steel threshold

## AVAILABLE FINISHES

Natural Select ★★★★★  
 Natural Oak, Ash, Walnut  
 Natural Oak Satin

CPL HQ 0,2 mm ★★★★★

CPL HQ 0,7 mm ★★★★★  
 Gladstone/Halifax

Finishes charts see page 250 – 257.

**NOTE!** Natural veneers (except Ash and Walnut) are available in vertical or horizontal grain direction (applies only to door leaf)

**NOTE!** It is recommended to choose CPL or Gladstone/Halifax laminate for entrance door, especially if they are used in public buildings.

## TECHNICAL INFORMATION

### DOOR LEAF CONSTRUCTION

Core: special 5-layer construction with rails and stiles made of glued laminated softwood, skinned with HDF and aluminium sheet. Core is also reinforced with steel rods.

### ACCESSORIES INCLUDED IN THE DOOR PRICE

- FUHR brand multipoint hook lock
- Heavy duty technical hinges
- 5 PCs of dog bolts
- Cylinder insert
- Dedicated handle
- Additionally: type II - high temperature intumescent seal on door leaf edges

### DOOR FRAMES

Corner profile steel door frame. Made from both sides galvanized steel sheet 1,5 mm thick. Equipped with self-adhesive gasket, eight dowel pins and, adjustable catch of lock hooks and stainless steel threshold.

### NOTES

- Norm PN EN 14351-2:2018 and PN EN 16034:2014-11
- In order to meet the requirements of building law, regarding fire-rating and/or smoke control, it is necessary to use a door closer or a closing device
- Door leaf and door frame are prepared for a door closer
- In case of using different hardware to offered by PORTA, guarantee cards guidelines must be followed

### EXTRA CHARGES

- spring loaded closer
- size '100'
- door leaf: CPL 0,2 mm and 0,7 mm veneers – GROUP II
- door leaf: Gladstone/Halifax finish, vertical graining
- decorative inlays for synthetic veneers (for 1 side, for both sides – the price x 2)
- decorative inlays for natural veneers (for 1 side, for both sides – the price x 2)
- door leaf: Natural veneer, White Oak, Satin
- door leaf: Natural veneer, Oak, Satin (other colours)
- door leaf: Natural veneer, Select black
- door leaf: Natural veneer: Walnut
- door leaf: model with crossed graining, Natural Select veneer
- door leaf: model with crossed graining, Natural veneer Oak, Ash, Walnut
- steel door frame: colours - GROUP II
- steel door frame: colours - GROUP III
- steel door frame profile for PROJECT BIS cover
- steel door frame profile for PROJECT Premium cover
- steel door frame profile from 101 to 150 mm
- steel door frame profile from 151 to 270 mm
- steel door frame profile from 271 to 390 mm
- door viewer
- panoramic door viewer

# GRANITE class C

anti-burglary doors, class C, EI 30, 32 dB

08



Burglary resistance class RC 3  
and class C  
Acoustic rating  $R_w=36$  dB\*  
Fire-resistance EI 30

GRANITE class C, Natural Walnut with a door frame and a PROJECT BIS door frame cover

All available models - see page 148

- Included in the price
- door leaf
  - frame
  - steel threshold
  - handle
  - euro cylinder
- Option at extra cost:
- additional top lock

## GRANITE DOORS cl. C

we offer two types:

### Type I

- „C“ burglary resistance class
- RC3 burglary resistance class according to PN EN 1627-2012
- Acoustic rating  $R_w=32$  dB (32-36 dB)
- Smoke control

### Type II

- Type I qualities
- Fire-resistance EI 30



GRANITE Solid, Natural Walnut with a steel door frame



two cylinder multipoint lock with security pins

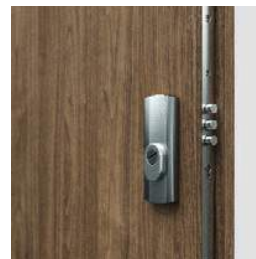

reinforced three-part hinge

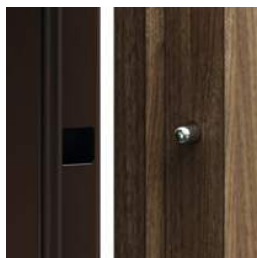

dog bolts

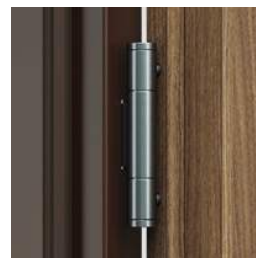

Detailed tests results are available on our website tab DOWNLOAD on [www.porta.com.pl](http://www.porta.com.pl)

DETAILED OFFER IS ALSO AVAILABLE ON [www.portadoors.com](http://www.portadoors.com)



## AVAILABLE FINISHES

Natural Select ★★★★★  
Natural Oak, Ash, Walnut  
Natural Oak Satin

CPL HQ 0,2 mm ★★★★★

CPL HQ 0,7 mm ★★★★★

Finishes charts see page 250 – 257.

**NOTE!** Natural veneers (except Ash and Walnut) are available in vertical or horizontal grain direction (applies only to door leaf)

**NOTE!** It is recommended to choose CPL or Gladstone/Halifax laminate for entrance door, especially if they are used in public buildings.

### WE RECOMMEND!

THANKS TO THE ALUMINIUM LAYER, GRANITE DOORS ARE EXCEPTIONALLY RESISTANT TO ADVERSE CONDITIONS OF USE, TEMPERATURE AND HUMIDITY DIFFERENCES, WHICH ARE COMMON IN COMMUNAL AREAS.



How to install Granite doors, using dowel pins - see video  
[www.porta.com.pl/dm/montazgranitnadyble.wmv](http://www.porta.com.pl/dm/montazgranitnadyble.wmv)

## TECHNICAL INFORMATION

### DOOR LEAF CONSTRUCTION

Rails and stiles made of glued softwood. The construction is skinned with special double layer aluminium sheet and HDF. Silver decorative inlays available. Natural veneers are finished with semi-matt varnish.

### ACCESSORIES INCLUDED IN DOOR PRICE

- Multipoint lock with security pins, class 4
- Two anti-burglary cylinders, class 'C'
- A handle with an anti-burglary escutcheon 'GRANITE' or 'GRANITE PLUS' (at an additional charge)
- Upper escutcheon
- Four dog bolts
- Preparation for shortening, maximum 60 mm (regards Granite type I)
- Additionally: type II - high temperature intumescent seal on door leaf edges
- Door frame equipped with a stainless steel threshold, (wider option- 120 mm) and reinforcement for a door closer

### DOOR FRAMES

- Corner profile steel door frame, profile 100 mm wide. Made from galvanized steel sheet 1,5 mm thick. Equipped with self-adhesive gasket, eight dowel pins and a stainless steel threshold (120 mm).
- PROJECT BIS door frame (see p. 218).
- PROJECT Premium (see p. 218).

### NOTES

- Technical Assessment ITB-KOT-2017/0242 issue 1.
- National certification of constancy of performance No 020-UWB-2618/W
- In order to meet the requirements of building law, regarding fire-rating and/or smoke control, it is necessary to use a door closer.

- Fire rated doors should be equipped with an escutcheon and a handle with a steel spindle
- In case of using different hardware to offered by PORTA, guarantee cards guidelines must be followed.
- Acoustic rating Rw=32 dB (32-36 dB).
- **Thanks to TechnoPORTA AQUA STOP technology door leaves finished with CPL HQ have lower edges protected against humidity..**

### EXTRA CHARGES

- door viewer
- panoramic door viewer
- size '100'
- an adjustable lock strike (Type I)
- door leaf: CPL 0,2 mm and 0,7 mm veneers – GROUP II
- decorative inlays for synthetic veneers (for 1 side, for both sides – the price x 2)
- decorative inlays for natural veneers (for 1 side, for both sides – the price x 2)
- door leaf: Natural veneer, White Oak, Satin
- door leaf: Natural veneer, Oak, Satin (other colours)
- door leaf: Natural veneer, Walnut
- door leaf: Natural veneer, Select Black
- steel door frame: polyester paint - GROUP II
- steel door frame: polyester paint - GROUP III
- steel door frame profile for PROJECT BIS cover
- steel door frame profile for PROJECT Premium
- door leaf: model with crossed graining, Natural Select veneer
- door leaf: model with crossed graining, Natural veneer Oak, Ash, Walnut
- steel door frame profile from 101 to 150 mm
- steel door frame profile from 151 to 270 mm
- steel door frame profile from 271 to 390 mm
- handle with escutcheon GRANITE PLUS

(see p. 232)

# Steel SAFE, ENERGY PROTECT

Burglar resistant locks, class 3 or 4. Anti-burglary glazing class P4

09



Steel SAFE E.1, Oak Winchester

APARTMENT ENTRANCE DOOR  
AND ENTRANCE DOOR

Burglary resistance RC2/RC3\*  
Thermal transmittance

$U_d = 1,1^*$   
W/m<sup>2</sup>K  
THERMAL  
TRANSMITTANCE

**P**  
GALVANIZED  
SHEET  
PRODUCT  
PORTASTEEL



Steel ENERGY PROTECT C.1, Oak Winchester

## PROTECTION SYSTEM OF STEEL SURFACES

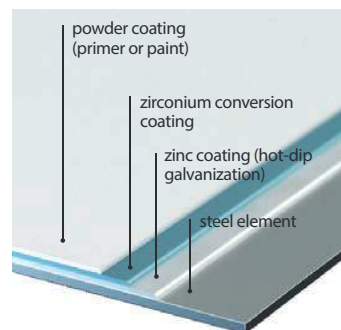

model A.0



model B.1



model C.1



model D.1

\* Regards solid doors only. Detailed tests results are available on our website tab DOWNLOAD on [www.porta.com.pl](http://www.porta.com.pl)



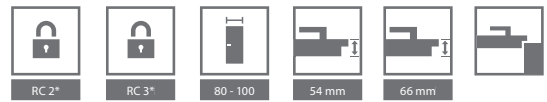

## AVAILABLE FINISHES

### Polyester Premium Paint ★★★★★☆



### Laminated steel sheet (PVC) ★★★★★☆

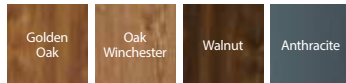

Steel door frame Thermo



Hook - upper/lower bolting.  
SAFE type III, ENERGY PROTECT



Multipoint lock SAFE type III,  
ENERGY PROTECT



4 dog bolts



3 PCs of three-part hinges



Infill - expanded polystyrene

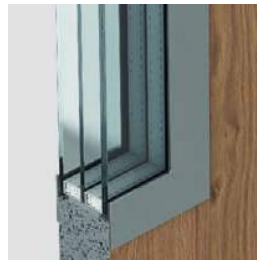

Triple glazing - class P4



Thermal barrier threshold - it  
reduces heat transfer coefficient  
along with Thermo' door frame

Steel SAFE  
ENERGY PROTECT

## TECHNICAL INFORMATION

### BASIC INFORMATION

- 'SAFE' doors (door leaf thickness 54 mm)
  - Burglar resistance class RC2 or RC 3 (regards solid door leaves)
  - Two independent LOB locks or Winkhaus STV hook lock
  - Corner profile frame 'LARGE' or Thermo' door frame
  - Stainless steel perforated threshold or a thermal barrier threshold
  - 3 PCs of three-part hinges
  - Four dog bolts
  - Handle: OPAL (RC2) or SAFE (RC3)
  - LOB or WILKA cylinders
  - Adjustable lock strike

### EXTRA CHARGES - SAFE DOORS TYPE II, III, ENERGY PROTECT

- size '100'
- door viewer
- bottom drip cap (door leaf colour)
- stainless steel kick panel 150 mm, models: A0, B1, F1
- mineral wool infill
- reinforcement for a door closer for door leaf
- reinforcement for a door closer for a door frame
- protection set for the bottom edge in case of self-shortening
- two cylinders LOB, class B - exchange for a standard set class A (SAFE TYPE II)
- lower cylinder WILKA class B - exchange for a STD set, class A (SAFE TYPE III)
- upper cylinder WILKA class A (SAFE TYPE III)
- A lower cylinder WILKA class B - exchange for std. set, class A (ENERGY PROTECT)
- Round or rectangular pull (see p. 233)

### BASIC INFORMATION

- 'ENERGY PROTECT' door (door leaf thickness 66 mm)
  - Burglar resistance class RC 3 (regards solid door leaves)
  - Winkhaus STV hook lock
  - Thermo' door frame
  - Stainless steel thermal barrier threshold
  - 3 PCs of three-part hinges
  - Four dog bolts
  - 'SAFE' handle
  - WILKA cylinder
  - Adjustable lock strike

### EXTRA CHARGES - TYPE III ENERGY PROTECT

- polyester paint - GROUP II
- additional upper lock
- upper cylinder WILKA, cl. B
- upper escutcheon class C
- An upper cylinder WILKA, class B

# Multipurpose doors for utility rooms and storage rooms

10



Multipurpose doors, model 2, Grey

Galvanised, robust universal door is ideal for utility rooms, industrial premises, as well as cellars, attics or in storage rooms.

right or left?  
**reversible!**

The price of a door set includes

- door leaf
- frame
- handle
- lock



GALVANIZED SHEET

PORTA STEEL PRODUCT



Industrial pattern  
W.121254

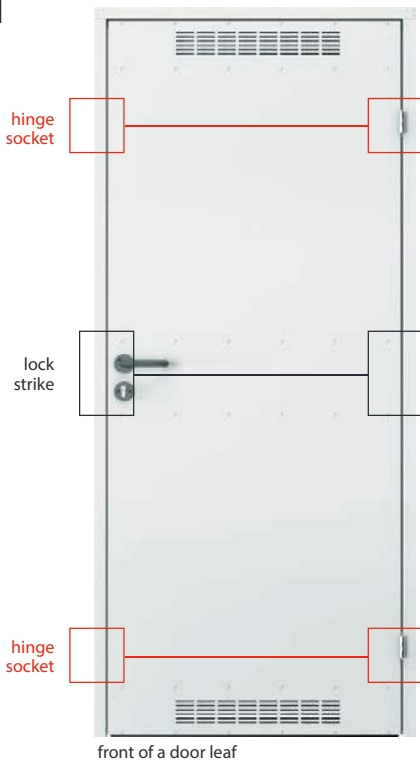

front of a door leaf



back of a door leaf

## PROTECTION SYSTEM OF STEEL SURFACES

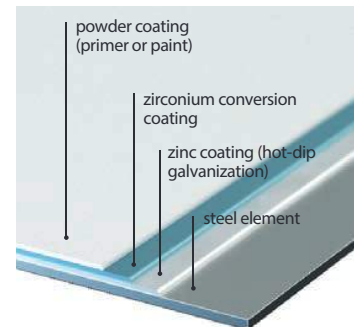



LONG LASTING DURABILITY



QUALITY GUARANTEED



MODERN DESIGN



EASY INSTALLATION



left / right



70 - 90



## AVAILABLE FINISHES

### Galvanized steel sheet ★★★★★☆



### Premium polyester paint ★★★★★☆

Group I	White MAT	Grey MAT	Structured anthracite
Group II	Structured Black		
Group III	White	Grey	Brown



handle



ventilation grille



4 ADVANTAGES IN 1  
SEE MORE

[www.porta.com.pl/dm/universalne\\_montaz.wmv](http://www.porta.com.pl/dm/universalne_montaz.wmv)

## TECHNICAL INFORMATION

### A DOOR SET INCLUDES

- Door leaf (paint coated galvanized steel sheet)
- Ventilation grille (optional)
- Two standard barrel hinges
- Cylinder lock
- Hinges caps (set for 1 PCs)
- Economical, plastic handle with a round escutcheon
- Corner profile frame

### A DOOR FRAME

- A corner profile frame, profile 48 mm wide. Made of 0,8 mm thick steel sheet, both sides galvanized.

### NOTES

- **Norm PN EN 14351-2:2018-12.**
- Thanks to symmetrical construction and reversible hardware (handle, hinges) doors can be installed as right or left-handed.
- **Galvanized steel sheet, reinforced in three levels.**

### EXTRA CHARGES

- polyester paint - GROUP II
- polyester paint - GROUP III

Multipurpose doors  
for utility rooms  
and storage rooms

# Steel BASIC, Steel BASIC PLUS

10



Steel BASIC, Grey

An economical solution while maintaining good performance. Galvanised sheet structure guarantees durability and reliability.



Steel BASIC PLUS, Coated steel sheet, Grey

## „Steel BASIC“: The price of the internal door set includes:

- a door leaf
- a door frame
- a handle
- galvanized steel construction

## „Steel BASIC PLUS“: The price of the external door set includes:

- a door leaf
- a door frame
- threshold
- a handle
- a galvanized steel construction

**P**  
GALVANIZED SHEET  
PORTA STEEL PRODUCT



handle and lock



ventilation grille



powder paint coated threshold (Steel BASIC PLUS)



drip cap (STEEL BASIC PLUS)





LONG LASTING DURABILITY



QUALITY GUARANTEED



MODERN DESIGN



EASY INSTALLATION



80 - 100



40 mm



## AVAILABLE FINISHES

### Galvanized steel sheet ★★★★★☆



### Coated steel sheet ★★★★★☆



honeycomb core



expanded polystyrene infill

## TECHNICAL INFORMATION

### DOOR SET INCLUDES

- A door leaf (steel sheet 0,5 mm, galvanized or galvanized and coated with a polyester paint)
- Two standard barrel hinges
- A cylinder lock
- A set of handles with escutcheons
- A corner profile frame (galvanized steel)
- A threshold (steel BASIC PLUS)
- A drip cap (steel BASIC PLUS) (see extra charges)

### DOOR LEAF INCLUDES

- A door leaf
- Two standard barrel hinges
- A cylinder lock

### DOOR FRAME

- A corner profile frame, profile 64 mm wide (like Corner profile - SMALL PLUS). Made of 1,2 mm thick steel sheet, galvanized or powder paint coated.
- Steel BASIC door frame has a seal. Steel BASIC PLUS has a seal set circumferentially.
- Door frame- right or left, ready to me mounted on a finished floor level.

### NOTES

- **STEEL BASIC Norm PN EN 14351-2:2018-12, internal doors.**
- **Steel BASIC PLUS: PN-EN 14351-1+A1:2010 external doors.**
- Steel BASIC doors available only in 'investment norm' (see dimensions see p. 242, tab 3).
- Steel BASIC door leaf is produced in Polish norm and investment norm
- Steel BASIC PLUS doors, inward opening, are equipped with a drip cap.
- **Due to the specifics of used material (coated steel), colours of the products are similar to colours of RAL palette.**

### EXTRA CHARGES

- drip cap (Steel BASIC PLUS)
- ventilation grille (Steel BASIC)

# Steel SOLID

10



Steel SOLID, solid, Grey

## USE OF THE DOOR

- designed for heavy duty applications
- utility rooms
- industrial premises
- back rooms
- cellars
- garages
- workshops
- industrial halls
- modern residential interiors and offices (loft design)

## PROTECTION SYSTEM OF STEEL SURFACES

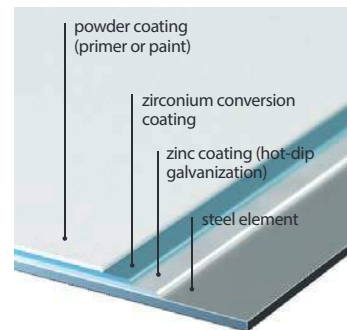

**P**  
GALVANIZED SHEET  
PORTA STEEL PRODUCT



Steel SOLID 1, Grey

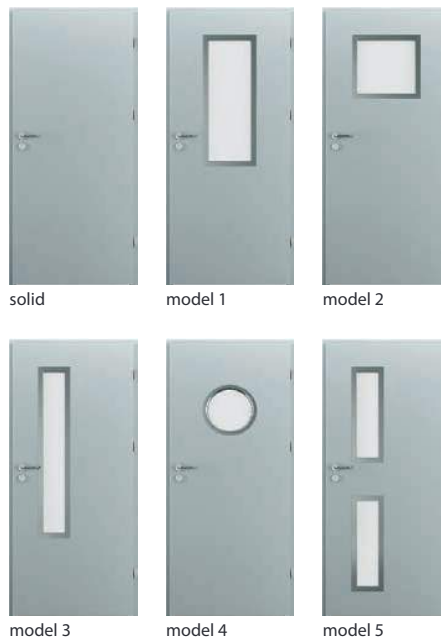





## AVAILABLE FINISHES

### Galvanized steel sheet ★★★★★☆



### Stainless steel ★★★★★★



### Premium polyester paint ★★★★★☆

Group I	White MAT	Grey MAT	Structured anthracite
	Structured Black		
Group III	White	Grey	Brown

### Laminated steel sheet (PVC) ★★★★★☆

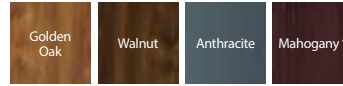

\* until stocks last



Custom colours available through Porta CONTRACT, details regarding bespoke orders, see page 261.



honeycomb core



expanded polystyrene infill

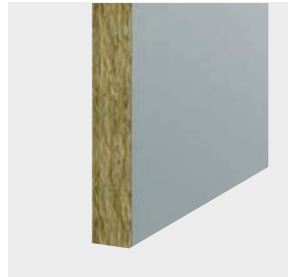

mineral wool infill

## TECHNICAL INFORMATION

### DOOR LEAF INCLUDES

- A door leaf (galvanized steel sheet 0,6 mm, powder paint coated)
- Two standard barrel hinges (three hinges for size '100')
- Cylinder lock
- Frosted or transparent glass panel

### SUGGESTED DOOR FRAMES

- Corner profile frame - SMALL PLUS, LARGE
- Steel ADJUSTABLE (standard), ADJUSTABLE 'PS' with 'sharp edges'
- Porta SYSTEM steel door frame

### NOTES

- Norm PN EN 14351-2:2018-12
- Door leaves with expanded polystyrene infill are available only in polyester premium paint finish.
- Door leaves skinned with laminated steel sheet - glazing available only with flat stainless steel glazing bead.

- Double doors are available in any door leaf size combinations.
- Stainless steel door leaves are available only in Porta CONTRACT offer (as a bespoke order).

### EXTRA CHARGES

- size '100' (galvanized steel doors)
- size '100' (stainless steel doors)
- polyester paint - GROUP II
- polyester paint - GROUP III
- Premium polyester paint and laminated steel (PCV): anthracite
- ventilation sleeves or ventilation grill (door leaves made of galvanized steel sheet)
- stainless steel ventilation grille
- reinforcement for a door closer
- handle with an escutcheon

(see p. 257)

# Steel EI 30 PLUS, EI 60 PLUS

10



Steel EI 60 PLUS, double leaf, solid, model 3, Grey Matt

EI 30 PLUS  
Fire resistance 30 min.  
Sound insulation  $R_w=32$  dB  
EI 60 PLUS  
Fire resistance 60 min.  
Sound insulation  $R_w=37$  dB\*

## PROTECTION SYSTEM OF STEEL SURFACES

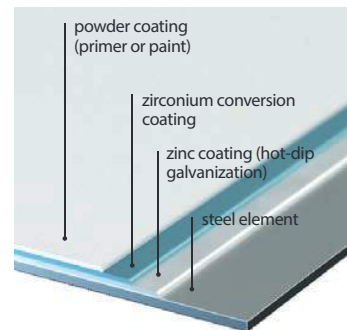

**P**  
GALVANIZED SHEET  
PORTA STEEL PRODUCT



Steel EI 30 PLUS, Grey



solid



model 2



model 3

Detailed tests results are available on our website tab DOWNLOAD on [www.porta.com.pl](http://www.porta.com.pl)



LONG LASTING DURABILITY



QUALITY GUARANTEED



MODERN DESIGN



EI60  
EI30



class 3  
class 2



60 - 100



120 - 180



62 mm



## AVAILABLE FINISHES

### Premium polyester paint ★★★★★☆

Group I	White MAT	Grey MAT	Structured anthracite
Group II	Structured Black		
Group III	White	Grey	Brown



Custom colours available through Porta CONTRACT, details regarding bespoke orders, see page 261.

### STEEL EI 30 AND EI 60 - INDICATIONS FOR USE:

- public buildings
- hotels, guesthouses
- boiler rooms
- garages



automatic shoot bolt



mortise cylinder lock, handle in the set



top/bottom lock bolt



intumescent seal

## TECHNICAL INFORMATION

### ACCESSORIES INCLUDED IN THE DOOR LEAF PRICE

- 2PCs of technical hinges. One is load-bearing, another, thanks to a spring in it, enables door to self-closing.
- A mortise cylinder lock
- Two dog bolts
- A set of handles with escutcheons (order separately)
- Transparent, fireproof glass panel

### DOOR FRAMES

- Corner profile steel frame. Made out of both sides hot-dip galvanized steel, 1,5 mm thick. Welded joint of frame corners (single leaf doors) and folded door frame (double leaf doors). Equipped with astragal.
- A door frame can be ordered in two options:
  - right or left door frame to install on a finished floor level - '0', threshold at an additional charge (EI 30 and EI 60)
  - right or left door frame to install below a floor level - '-30', threshold at an additional charge (EI 30 and EI 60)

### NOTES

- Norm PN-EN 14351-2:2018-12, Norm PN-EN 16034:2014-11.
- Technical Assessment, ITB Warsaw
- In case of using different hardware to offered by PORTA, guarantee cards guidelines must be followed.

### EXTRA CHARGES

- size '100' (EI 30)
- size '100' (EI 60)
- colours - GROUP II\*
- colours - GROUP III\*
- a stainless steel threshold\*
- a reinforcement for door closer\*

\*Price for double leaf door x2



## DOOR FRAMES

There is no complete door set without a door frame. For each of offered door leaf we recommend door frame which is suitable for the door you choose, both technically and aesthetically.





# MINIMAX

11

## FIXED DOOR FRAME. REBATED

Door frames recommended for interiors where adjustments to a wall is not required.

Door frames of 100 mm profile are compatible with any door leaf.

Door frames of 60 mm profile are compatible with door leaves finished with Portadecor and Portasynchro 3D veneers.

### AVAILABLE FINISHES

Portadecor ★★★  
Portasynchro 3D

Portadur ★★★★★  
Premium veneer  
Natural Select  
Natural Oak, Walnut, Ash  
Natural Oak Satin  
UV acrylic paint

Portaperfect 3D ★★★★★  
Portalamino  
CPL HQ 0,2 mm  
Gladstone/Halifax

Finishes charts see page 250 – 257.

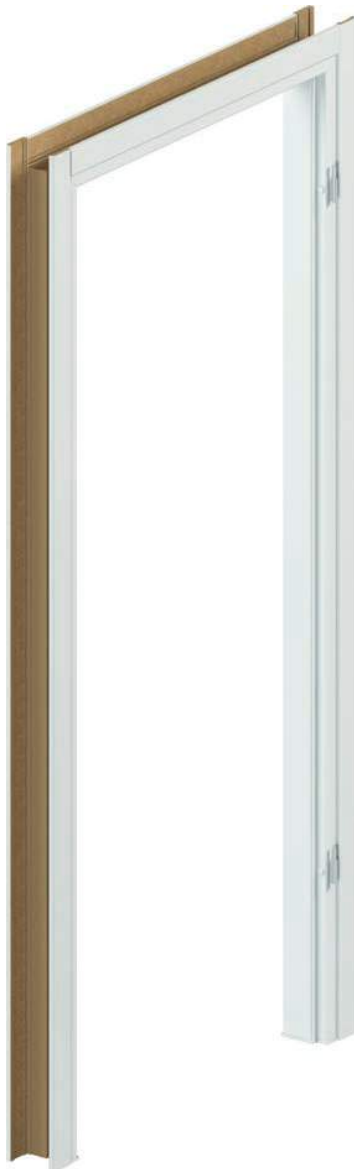

### DOOR FRAME - CROSS SECTION



60 mm,  
basic option  
without architraves



60 mm,  
synthetic veneer  
(with architraves)



100 mm synthetic veneer  
(architraves joined at 90° angle)  
or natural veneers (architraves  
joined at 45° angle)



100 mm,  
synthetic or natural veneer  
(with rounded architraves)



Door frames, architraves and quarterrounds are also available in a synthetic veneer for self-painting.

## TECHNICAL INFORMATION

### DOOR FRAME CONSTRUCTION

#### A door frame consists of:

- Door frame head and two jambs, made of MDF, with hardware and accessories
- Architraves (at additional charge)
- Quarter round (at additional charge)
- Door frame is produced and delivered as a set of elements to assemble on site. MINIMAX door frame for Porta GRANDE door leaf is finished with primer foil and paint hardened under UV lamp.

### ACCESSORIES- IN THE PRICE OF MINIMAX 60 MM

(available only in Portadecor and Portasynchro 3D finishes)

- Two or three standard barrel hinges or PRIME hinges (optionally at extra charge)
- Door stops
- Dowel pins, hole plugs
- Humidity protecting plugs for bottom part of a door frame

### ACCESSORIES- IN THE PRICE OF MINIMAX 100 MM

#### Synthetic veneers:

- Two or three standard barrel hinges or PRIME hinges (optionally at extra charge)

#### Natural veneers:

- Three standard barrel hinges or PRIME hinges
- A rubber seal set circumferentially
- Humidity protecting plugs for bottom part of a door frame

### DOOR FRAME SIZE, SEE PAGE 240 TABLE 1

Profile width 60 mm and 100 mm

Available sizes '60', '70', '80', '90' and '100', and any combination of these sizes for double leaf doors.

### NOTES

- Technical Assessment ITB-KOT-2018/0358, issue 1
- Door frames should be installed on finished walls (e.g. wall papers) and on a finished floor (e.g. floor panels)
- 100 mm door frame is also available in a 'tunnel' option (without a rebate, a seal, hinges or a strike plate)
- Door frames and architraves are available in unpainted option (for self-finishing).
- Size, 100' requires third hinge

### EXTRA CHARGES

- door frame: CPL 0,2 mm finish - GROUP II
- door frame: Natural veneer: Walnut
- door frame: Natural veneer, White Oak, Satin
- architraves: Natural veneer, White Oak, Satin
- quarterround: Natural veneer, White Oak, Satin
- PRIME hinges

# Porta SYSTEM, Porta SYSTEM GK

11

## PORTA SYSTEM

Adjustable door frame with architraves  
- 60 or 80 mm. Porta System is easy to install and  
it is compatible with all of internal door leaves.  
Thanks to the availability of the Retro Module  
you can achieve completely new and very  
different door styling.

## PORTA SYSTEM GK

Adjustable door frame for glass door leaves,  
produced in Polish Norm. Only such a set  
guarantees high performance and  
satisfaction with your purchase.

### AVAILABLE FINISHES

Portadecor ★★★  
Portasynchro 3D

Portadur ★★★★★  
Premium veneer  
Natural Select  
Natural Oak, Walnut, Ash  
Natural Oak Satin  
UV acrylic paint

Portaperfect 3D ★★★★★  
Portalamino  
CPL HQ 0,2 mm  
Gladstone/Halifax

Finishes charts see page 250 – 257.



### DOOR FRAME - CROSS SECTION

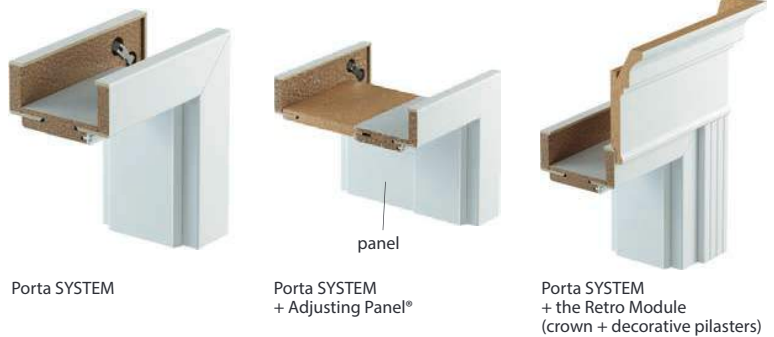

### ADJUSTMENT RANGE

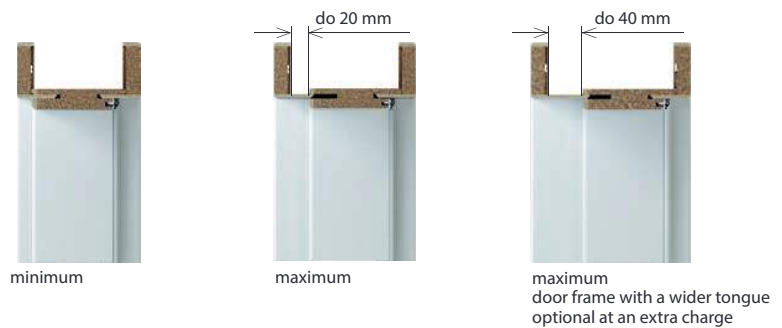

### ADJUSTING PANEL WIDTH

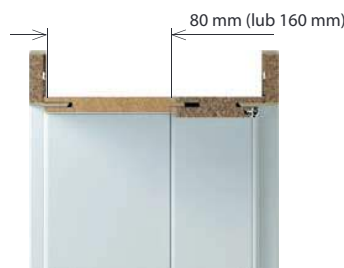

Installation of Porta SYSTEM, see video:  
<https://www.youtube.com/watch?v=w71vInxFg2Y>



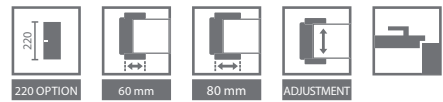

## ADJUSTMENT RANGES

A	75 ÷ 95
B	95 ÷ 115
C	120 ÷ 140
D	140 ÷ 160
E	160 ÷ 180
F	180 ÷ 200
G	200 ÷ 220
H	220 ÷ 240
I	240 ÷ 260
J	260 ÷ 280
K	280 ÷ 300
L	300 ÷ 320
M	320 ÷ 340
N*	340 ÷ 360

\* Zakres N niedostępny w wykończeniu Farba Akrylowa UV i Okleiny Naturalne



## TECHNICAL INFORMATION

### DOOR FRAME CONSTRUCTION

#### A door frame consists of:

- A door frame head and two jambs, made of wood-based material. It comes with hardware and accessories
- Architraves (60, 80 mm).

The door frame is produced and delivered as a set of elements to be assembled on site. PORTA SYSTEM door frame for Porta GRANDE door leaf is finished with primer foil and paint hardened under UV lamp.

### ACCESSORIES INCLUDED IN THE DOOR FRAME PRIC

#### Porta SYSTEM

##### Synthetic veneers:

- Two or three standard barrel hinges or PRIME hinges (optionally at extra charge)
- A rubber seal set circumferentially

##### Natural veneers:

- Two or three standard barrel hinges or PRIME hinges
- A rubber seal set circumferentially

#### Porta SYSTEM GK

- A strike plate (small)
- A rubber seal set circumferentially
- Hinge receivers, 2 PCs for size '60'-'90', 3 PCs for size '100'

**NOTE! Hinges are not included in a door frame set.**

### DOOR FRAME SIZE, SEE PAGE 240, TABLE 1

#### Porta SYSTEM

- Wall thicknesses (A-K) '60'; '70'; '80'; '90'; '100'; '110', and '120'-'200' and single leaf '60'-'90' with a side panel '40'\*

#### Porta SYSTEM GK

- Wall thicknesses (A-K) '60'; '70'; '80'; '90'; '100'

### NOTES

- Technical Assessment ITB-KOT-2018/0358, issue 1
- Door frames should be installed on finished walls (e.g. wall papers) and on a finished floor (e.g. floor panels)
- The door frame is also available in a 'tunnel' option (without a rebate, a seal, hinges or a strike plate)
- Module RETRO is not available in following finishes: CPL HQ, Premium veneer and Gladstone/Halifax.
- Size, '100' requires third hinge
- PORTA SYSTEM TRANSOMS- information available on [porta.com.pl/do-pobrania](http://porta.com.pl/do-pobrania).
- Height, '220': finishes - Premium veneer, UV acrylic paint, natural veneer, three hinges as a standard
- Range M finished with UV Acrylic paint and with Natural veneers consists of beam for L range and architrave with long tongue

### EXTRA CHARGES

- door frame: CPL 0,2 mm finish - GROUP II
- door frame: Natural veneer: Walnut
- door frame: Natural veneer: Black
- door frame: Natural veneer, White Oak, Satin
- adjusting panel: Natural veneer, White Oak, Satin
- crown: Natural veneer, White Oak, Satin
- decorative pilasters: Natural veneer, White Oak, Satin
- PRIME hinges
- investment set
- reinforcement for a door closer
- electric strike: fail safe or fail secure

(see 235)

# Porta SYSTEM ELEGANCE, Porta SYSTEM ELEGANCE 90 degrees

11

## ADJUSTABLE DOOR FRAME WITH 80 MM ARCHITRAVES. NON-REBATED.

Internal door frame which is compatible with non-rebated door leaves. Easy to install. Possibility of joining architraves at 45 degrees (Porta SYSTEM ELEGANCE) and 90 degrees (Porta SYSTEM ELEGANCE 90 degrees).

### AVAILABLE FINISHES

Portadecor ★★★  
Portasynchro 3D

Portadur ★★★★★  
Premium veneer  
Natural Select  
Natural Oak, Walnut, Ash  
Natural Oak Satin  
UV acrylic paint

Portaperfect 3D ★★★★★  
Portalamino  
CPL HQ 0,2 mm  
Gladstone/Halifax

Finishes charts see page 250 – 257.

### DOOR FRAME - CROSS SECTION

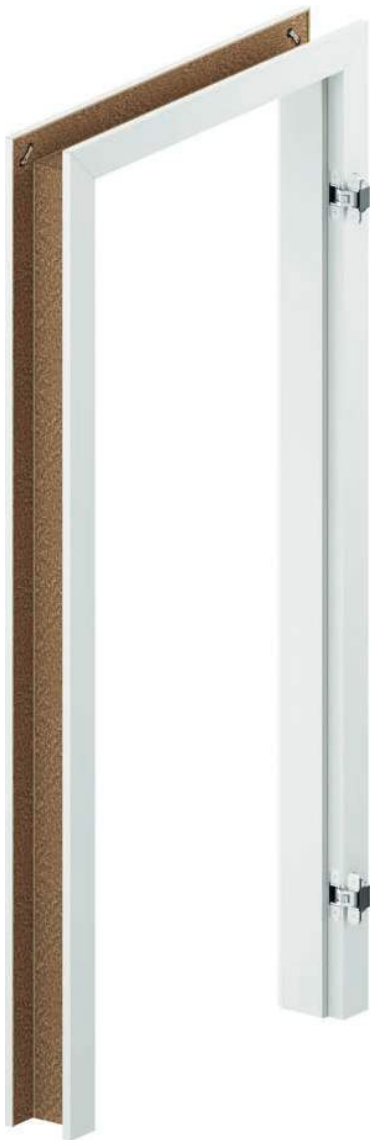

door frame profile - wide architrave 80 mm

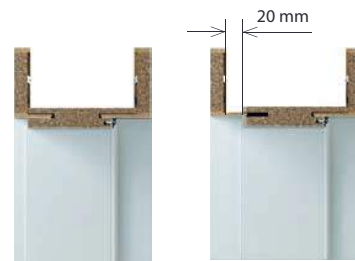

minimum

maximum

### ARCHITRAVES JOINING Porta SYSTEM ELEGANCE 90 degrees



Illustrative drawings



Flush surface. Door frame finished with Premium veneer.



Main beam recessed. Door frame finished with UV acrylic paint.



Flush surface. Door frame finished with Natural veneer.



How to install  
Porta SYSTEM ELEGANCE



How to install and adjust 3D hinge:  
<https://www.youtube.com/watch?v=2vavrJrZ9Kc>

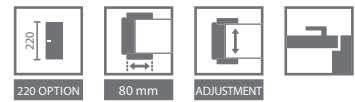

#### PORTA SYSTEM ELEGANCE ADJUSTMENT RANGES

B	95 ÷ 115
C	120 ÷ 140
D	140 ÷ 160
E	160 ÷ 180
F	180 ÷ 200
G	200 ÷ 220
H	220 ÷ 240
I	240 ÷ 260
J	260 ÷ 280
K	280 ÷ 300

#### PORTA SYSTEM ELEGANCE 90 DEGREES ADJUSTMENT RANGES

B	95 ÷ 115
C	120 ÷ 140
D	140 ÷ 160
E	160 ÷ 180
F	180 ÷ 200
G	200 ÷ 220
H	220 ÷ 240
I	240 ÷ 260
J	260 ÷ 280
K	280 ÷ 300



3D hinge (closed door)



3D hinge (opened door)

#### KEY FEATURES OF THE NEW SIMONSWERK 3D HINGE:

- CONVENIENT 3DADJUSTMENT
- 200.000 TEST CYCLES IN CONTINUOUS OPERATION
- LOAD CAPACITY 60 KG (2 HINGES),
- ALL VISIBLE ELEMENTS ARE FINISHED WITH POLYESTER COATING

#### WE RECOMMEND!

SKIRTINGS BOARD see page 205

## TECHNICAL INFORMATION

### DOOR FRAME CONSTRUCTION

#### A door frame consists of:

- A door frame head and two jambs, made of wood-based material. It comes with hardware and accessories
- Architraves 80 mm
- Architrave edge radius, aris', for natural veneers Standard, Select, Satin.
- Architrave edge radius 1,5 mm for synthetic finishes: Portadecor, Portasynchro 3D, Portadur and Portaperfect 3D. 3mm radius for CPL HQ 0,2 mm.
- PS ELEGANCE is produced and delivered as a set of elements to assemble on site.
- PS ELEGANCE door frame for Porta GRANDE door leaf is finished with primer foil and paint hardened under UV lamp.

### ACCESSORIES INCLUDED IN THE DOOR FRAME PRICE

- Two sets of adjustable 3D hinges
- A rubber seal set circumferentially

### DOOR FRAME SIZE, SEE PAGE 240, TABLE 1

- Ten adjustment ranges from 95 mm to 300 mm; '60'; '70'; '80'; '90'; '100'; and '120'-'200'

### NOTES

- Technical Assessment ITB-KOT-2018/0358, issue 1
- Porta SYSTEM ELEGANCE 90 degrees is available in following finishes: Premium veneer, UV acrylic paint, Natural veneer
- Door frames should be installed on finished walls (e.g. wall papers) and on a finished floor (e.g. floor panels)

- The door frame is also available in a, 'tunnel' option (without a rebate, a seal, hinges or a strike plate)
- **Height 220 cm is available in following finishes: Premium veneer, UV acrylic paint, Natural veneer. Three hinges as a standard.**
- Range M finished with UV Acrylic paint and with Natural veneers consists of beam for L range and architrave with long tongue

### EXTRA CHARGES

- door frame: CPL 0,2 mm finish - GROUP II (applies to PS ELEGANCE)
- door frame: Natural veneer: Walnut
- door frame: Natural veneer: Black
- door frame: Natural veneer, White Oak, Satin
- gold 3D hinges (extra charge added to a door frame price)
- third 3D hinge - silver, white, black (extra charge added to a door frame price)
- third 3D hinge - gold (extra charge added to a door frame price)
- reinforcement for a door closer (applies to PS ELEGANCE)
- door frame 220 Acrylic Paint
- door frame 220 Natural veneer
- door frame 220 Premium veneer
- architraves 100 mm (apply to height 220 cm, PS ELEGANCE finished with Natural veneer)

# PORTA SYSTEM with reversed rebate

## NON-REBATED ADJUSTABLE DOOR FRAME WITH 80 MM ARCHITRAVES AND REVERSED REBATE

Complement to non-rebated collections. Closed door with Porta SYSTEM ELEGANCE frame and Porta SYSTEM frame with reversed rebate look the same and allow you to open the door in different directions: Porta SYSTEM ELEGANCE outwards, and Porta SYSTEM with reversed rebate inwards.

### AVAILABLE FINISHES

Premium veneer ★★★★★  
Natural Select  
Natural Oak, Walnut, Ash  
Natural Satin Oak  
UV acrylic paint

Finishes charts see page 250 – 257.



### DOOR FRAME - CROSS SECTION



### DOOR OPENING DIRECTION

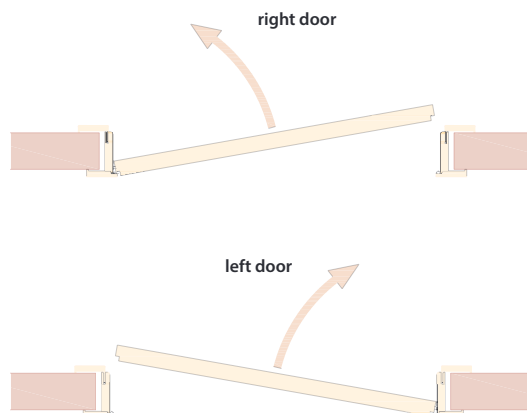

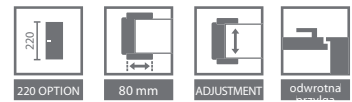

## ADJUSTMENT RANGES

B	95 ÷ 115
C	120 ÷ 140
D	140 ÷ 160
E	160 ÷ 180
F	180 ÷ 200
G	200 ÷ 220
H	220 ÷ 240
I	240 ÷ 260
J	260 ÷ 280
K	280 ÷ 300



Door frame corner from hinges side



Door frame corner from hinges side

### KEY FEATURES OF THE NEW SIMONSWERK 3D HINGE:

- CONVENIENT 3D ADJUSTMENT
- 200.000 TEST CYCLES IN CONTINUOUS OPERATION
- LOAD CAPACITY 60 KG (2 HINGES),
- ALL VISIBLE ELEMENTS ARE FINISHED WITH POLYESTER COATING

### WE RECOMMEND!

SKIRTINGS BOARDS FINISHED WITH UV ACRYLIC PAINT  
see page 250

## TECHNICAL INFORMATION

### DOOR FRAME CONSTRUCTION

#### The door frame consists of:

- A door frame head and two jambs, made of wood-based material. It comes with hardware, accessories and architraves 80 mm on both sides
- Architrave edge radius, arris, for natural veneers Standard, Select, Satin.
- Architrave edge radius 1,5 mm for Premium veneer and UV acrylic paint
- The door frame is produced and delivered as a set of elements to assemble on site.

### APPLICATION

- Door leaves dedicated for Porta SYSTEM door frames with reversed rebate:
- painted collections: Porta VECTOR Premium, Porta DESIRE, Porta FOCUS Premium, Porta GRANDE,
  - collections finished with natural veneers: Nature CLASSIC, Nature GRANDE, Nature LINE.

### ACCESSORIES INCLUDED IN THE DOOR FRAME PRICE

- Two sets of adjustable 3D hinges
- A rubber seal set circumferentially

### DOOR FRAME SIZE

- Ten adjustment ranges from 95 mm to 300 mm; '60', '70', '80', '90', '100'

### NOTES

- Technical Assessment ITB KOT-2018/0358, issue 1
- Door frames should be installed on finished walls (e.g. wall papers) and on a finished floor (e.g. floor panels)
- **Height, 220' - 3 hinges in standard**

### EXTRA CHARGES

- door frame, 220': Premium veneer
- door frame, 220': UV acrylic paint
- door frame, 220': Natural veneer
- door frame: Natural veneer Walnut
- door frame: Natural veneer Black
- door frame: Natural veneer Satin white
- execution of a chosen door leaf in the reversed rebate system (extra charge is added to door leaf price)

PORTA SYSTEM  
with reversed  
rebate

11

## UNIQUE AND INNOVATIVE ADJUSTABLE DOOR FRAME

Adjustable door frame with 80 mm architraves.  
Non-rebated with an upper panel  
- 20 or 100 cm high.

### AVAILABLE FINISHES

Portadecor ★★★  
Portasynchro 3D

Premium veneer ★★★★★  
UV acrylic paint

Portaperfect 3D ★★★★★  
Portalamino

Finishes charts see page 250 – 257.

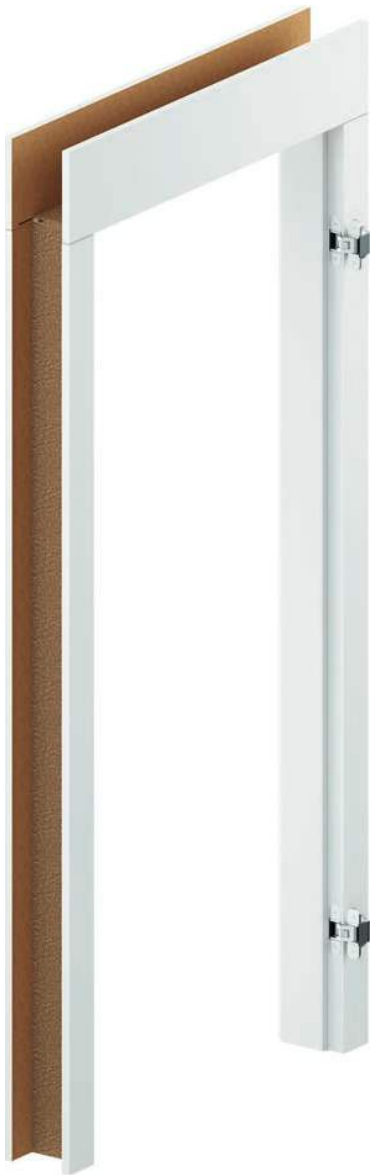

### DOOR FRAME - CROSS SECTION

Cut to size yourself to fit the needed height.



### DOOR FRAME - CROSS SECTION

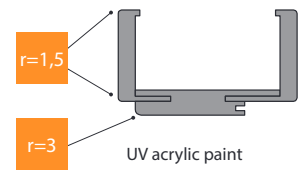
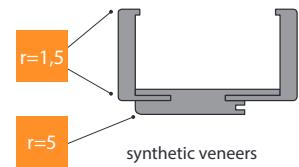

### ADJUSTMENT RANGE

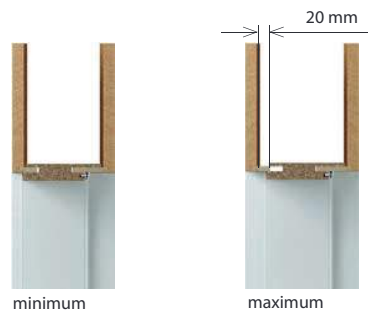

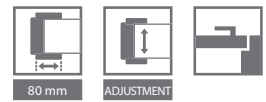

#### ADJUSTMENT RANGES

B	95 ÷ 115
C	120 ÷ 140
D	140 ÷ 160
E	160 ÷ 180
F	180 ÷ 200
G	200 ÷ 220
H	220 ÷ 240
I	240 ÷ 260
J	260 ÷ 280
K	280 ÷ 300

#### UPPER PANELS

200 mm (2x)

1000 mm (2x)

200 and 1000 mm (1/1)



Installation of LEVEL door frame, see video:  
[www.porta.com.pl/dm/montazosclevel.wmv](http://www.porta.com.pl/dm/montazosclevel.wmv)



Door frame for a double-leaf door and/or finished with CPL HQ - order through Porta CONTRACT, see page 261.

#### KEY FEATURES OF THE NEW SIMONSWERK 3D HINGE:

- CONVENIENT 3DADJUSTMENT
- 200.000 TEST CYCLES IN CONTINUOUS OPERATION
- LOAD CAPACITY 60 KG (2 HINGES),
- ALL VISIBLE ELEMENTS ARE FINISHED WITH POLYESTER COATING

#### WE RECOMMEND!

SKIRTINGS BOARDS see page 250

## TECHNICAL INFORMATION

### DOOR FRAME CONSTRUCTION

#### A door frame consists of:

- A door frame head and two jambs, made of wood-based material. It comes with hardware and accessories
- Architraves 80 mm
- Two vertical panels (order separately)
- Vertical grain direction for a LEVEL panel. For chosen finishes horizontal grain direction available (see p. 100)
- Architrave edge radius - 1,5 mm. LEVEL door frame is produced and delivered as a set of elements to be assembled on site. LEVEL door frame for UV painted door leaves is finished with primer foil and paint hardened under UV lamp.

### ACCESSORIES INCLUDED IN THE DOOR FRAME PRICE

- Two sets of adjustable 3D hinges
- A rubber seal set circumferentially

### DOOR FRAME SIZE, SEE PAGE 240, TABLE 1

Ten adjustment ranges from 95 mm to 300 mm; '60'; '70'; '80'; '90'; '100'

### NOTES

- Technical Assessment ITB-KOT-2018/0358, issue 1
- Door frames should be installed on finished walls (e.g. wall papers) and on a finished floor (e.g. floor panels)
- Door frame is also available in a 'tunnel' option (without a rebate, a seal, hinges or a strike plate)

### EXTRA CHARGES

- gold 3D hinges (extra charge added to a door frame price)
- third 3D hinge - silver, white, black (extra charge added to a door frame price)
- third 3D hinge - gold (extra charge added to a door frame price)

# Porta RENOVA

11

## GIVE YOUR APARTMENT UNIQUE CHARACTER

This solution gives you the possibility to change doors without dismantling the old door frame.

### AVAILABLE FINISHES

Portadecor  
Portasynchro 3D ★★★

Portadur  
Premium veneer ★★★★★

Portaperfect 3D  
Portalamino  
CPL HQ 0,2 mm ★★★★★

Finishes charts see page 250 – 257.



### DOOR FRAME - CROSS SECTION



### ADJUSTMENT RANGE

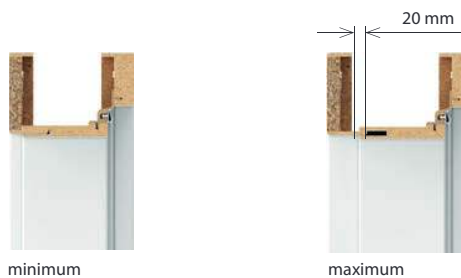



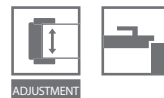

#### ADJUSTMENT RANGES

S	55 ÷ 75
A	75 ÷ 95
B	95 ÷ 115
C	120 ÷ 140
D	140 ÷ 160
E	160 ÷ 180
F	180 ÷ 200
G	200 ÷ 220
H	220 ÷ 240
I	240 ÷ 260
J	260 ÷ 280

#### PORTA RENOVA' OFFER INCLUDES:

- Porta RENOVA door frame, adjustment range from 'A' to 'J' + size 'S' 55-75 mm
- 'tunnel' option, adjustment range from 'A' to 'J'
- head and jambs with a tongue (broadening PORTA RENOVA adjustment) from 'A' to 'J'

## TECHNICAL INFORMATION

#### DOOR FRAME CONSTRUCTION

##### A door frame consists of:

- A door frame head and two jambs, made of wood-based materials
- Architraves
- Architrave edge radius 'arris', for natural veneers Standard, Select, Satin.
- Porta RENOVA is produced and delivered as a set of elements to assemble on site.

#### ACCESSORIES INCLUDED IN DOOR FRAME PRICE

- Two or three standard barrel hinges

#### DOOR FRAME SIZE, SEE PAGE 240, TABLE 1

- For adjustment ranges ('S' + A-J) '60', '70', '80', '90', '100', '110':

#### NOTES

- RENOVA door frame is available with Individual Approval Documentation
- Door frames should be installed on finished walls (e.g. wall papers) and on a finished floor (e.g. floor panels)
- Door frame is also available in a 'tunnel' option (without a rebate, a seal, hinges or a strike plate)
- Additional broadening (head and jambs)
- The door frame is compatible with standard door leaves. If client chooses a handle with an escutcheon wider than 44 mm, they have to order a door leaf with a 60 mm lock.
- All crooks and unevenness of a wall and old door frame have to be taken into consideration during wall opening measurement.

# Villadora RETRO

11

## ADJUSTABLE DOOR FRAME, RETRO'

Internal adjustable door frame dedicated for the Villadora RETRO door leaves.

### AVAILABLE FINISHES

Natural Oak Satin



Finishes charts see page 250 – 257.

### DOOR FRAME - CROSS SECTION VILLADORA RETRO



door frame profile - wide architrave 80 mm



The Retro module.  
(crown and pilasters)

### ADJUSTMENT RANGE



minimum



maximum

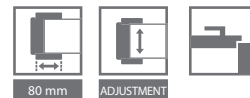

#### ADJUSTMENT RANGES

A	75 ÷ 95 mm
B	95 ÷ 115 mm
C	120 ÷ 140 mm
D	140 ÷ 160 mm
E	160 ÷ 180 mm
F	180 ÷ 200 mm
G	200 ÷ 220 mm
H	220 ÷ 240 mm
I	240 ÷ 260 mm
J	260 ÷ 280 mm
K	280 ÷ 300 mm

• Extra charge for double leaf option +50%



## TECHNICAL INFORMATION

### DOOR FRAME CONSTRUCTION

#### A door frame consists of:

- A door frame head and two jambs, made of wood-based material. It comes with hardware and accessories
- Architraves

Villadora RETRO is produced and delivered as a set of elements to be assembled on site.

### ACCESSORIES INCLUDED IN THE DOOR FRAME PRICE

- Three sets fo adjustable barrel hinges (3D)
- A rubber seal set circumferentially

### DOOR FRAME SIZE, SEE PAGE 240, TABLE 1

Adjustment ranges (A-K): '60', '70', '80', '90', '100' and '120' ÷ '200'.

### NOTES

- Technical Assessment ITB-KOT-2018/0358, issue 1
- Door frames should be installed on finished walls (e.g. wall papers) and on a finished floor (e.g. floor panels)

# Steel Porta SYSTEM ELEGANCE

## Steel Porta SYSTEM

12

### INTERNAL STEEL DOOR FRAME

Adjustable steel door frame. It has the same advantages as wooden Porta SYSTEM and Porta SYSTEM ELEGANCE door frame when it comes to installation, design and adjustment. At the same time steel construction and galvanic varnished surface protection makes this product perfect for use in demanding areas with increased humidity or temperature changes. Ideal as an internal door frame for use in residential buildings.

#### AVAILABLE FINISHES

Premium polyester paint ★★★★★☆

Group I	White MAT	Grey MAT	Structured anthracite	Group II	Structured Black
	Beige MAT	Brown MAT	Anthracite HPL/CPL		Group III

Finishes charts see page 250 – 257.



Steel Porta SYSTEM

Steel Porta SYSTEM ELEGANCE

#### DOOR FRAME CROSS SECTION Steel Porta SYSTEM



#### DOOR FRAME CROSS SECTION Steel Porta SYSTEM ELEGANCE





LONG LASTING DURABILITY



QUALITY GUARANTEED



MODERN DESIGN



EASY INSTALLATION



220 OPTION



ADJUSTMENT



ADJUSTMENT



#### WALL THICKNESSES

A	95 ÷ 120 mm
B	121 ÷ 145 mm
C	146 ÷ 170 mm
D	171 ÷ 195 mm

#### STEEL PORTA SYSTEM - ADJUSTMENT RANGES

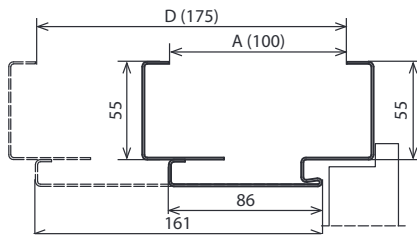

#### HOW TO ADJUST PORTA SYSTEM STEEL DOOR FRAME

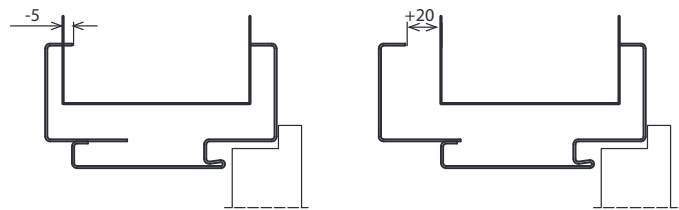

#### STEEL PORTA SYSTEM ELEGANCE - ADJUSTMENT RANGES

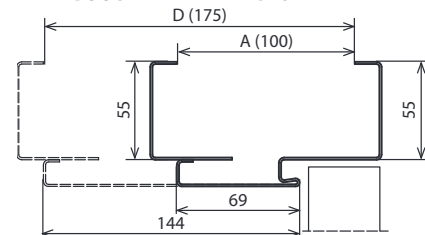

#### HOW TO ADJUST PORTA SYSTEM ELEGANCE STEEL DOOR FRAME

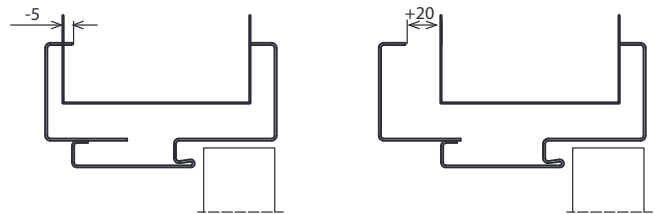

#### TECHNICAL INFORMATION

##### DOOR FRAME CONSTRUCTION

This adjustable door frame is made out of the best quality galvanized steel, 1,2 mm thick.

##### A door frame consists of:

- standard barrel hinges (steel Porta SYSTEM)
- adjustable 3D hinges (steel Porta SYSTEM ELEGANCE)
- adjustable part, wrapping the wall -5, +20 mm
- A rubber seal
- fixed part mounted on a wall (with necessary accessories)
- Reinforcement for the lock strike

##### ACCESSORIES INCLUDED IN THE DOOR FRAME PRICE

- Two or three standard barrel hinges (steel Porta SYSTEM)
- Two adjustable 3D hinges (Porta SYSTEM ELEGANCE)
- An allen key
- A rubber seal available in following colours: white, grey, brown, beige and anthracite
- An anchoring plate
- Reinforcement for the lock strike

##### DOOR FRAME SIZE, SEE PAGE 240, TABLE 2

- '60', '70', '80', '90', '100' and '120' ÷ '200'
- To be installed on a finished floor level '0'.

##### NOTES

- Technical Assessment ITB-KOT-2017/0245 issue 1.
- Certificate of conformity no. ITB-2617/W, ITB Warsaw.
- Door frames should be installed on finished walls (e.g. wall papers) and on a finished floor (e.g. floor panels).
- Polyester Premium paint Anthracite HPL/CPL id dedicated for door leaves finished with HPL/CPL Anthracite.
- Size '80' and '90' in the 'Investment Norm' (clear opening width 800, 900 mm) available as a standard - without extra charge.

##### EXTRA CHARGES

- polyester paint - GROUP II
- polyester paint - GROUP III
- door frame 220
- investment set\*
- reinforcement for a door closer
- third 3D hinge, silver, white, black

\*accessories and extra charge applies to steel Porta SYSTEM

# Adjustable non-rebated steel, Adjustable, Adjustable PS with ,sharp edges'

12

## INTERNAL STEEL DOOR FRAME

Main benefits of these products are: precise design of all elements and easy installation as well as value for money.

Adjustment feature allows for installation to almost any wall width. The door frame can be used in virtually all types of buildings: apartments, offices, hotels, factories, industrial buildings and any other place where high durability is required.

### AVAILABLE FINISHES

Premium polyester paint ★★★★★☆

Group I	White MAT	Grey MAT	Structured anthracite	Group II	Structured Black
	Beige MAT	Brown MAT	Anthracite HPL/CPL		Group III

Finishes charts see page 250 – 257.



DOOR FRAME CROSS SECTION Adjustable



DOOR FRAME CROSS SECTION Adjustable non-rebated



DOOR FRAME CROSS SECTION PS with ,sharp edges'





### Adjustable

#### WALL THICKNESSES

A	95 ÷ 120 mm
B	121 ÷ 145 mm
C	146 ÷ 170 mm
D	171 ÷ 195 mm
E	196 ÷ 220 mm
F	221 ÷ 245 mm
G	246 ÷ 270 mm
H	271 ÷ 295 mm

### Adjustable PS with 'sharp edges'

#### WALL THICKNESSES

A	95 ÷ 120 mm
B	121 ÷ 145 mm
C	146 ÷ 170 mm
D	171 ÷ 195 mm
E	196 ÷ 220 mm
F	221 ÷ 245 mm
G	246 ÷ 270 mm
H	271 ÷ 295 mm



You will find more information in the catalogue of STEEL DOOR FRAMES [porta.com.pl/do-pobrania](http://porta.com.pl/do-pobrania)

## ZADJUSTABLE FRAME - ADJUSTMENT RANGES

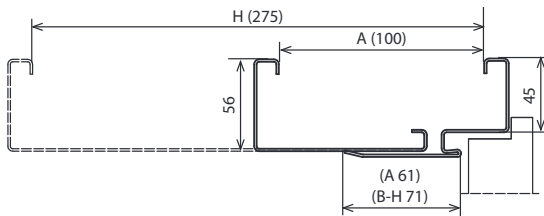

## HOW TO ADJUST ADJUSTABLE DOOR FRAME

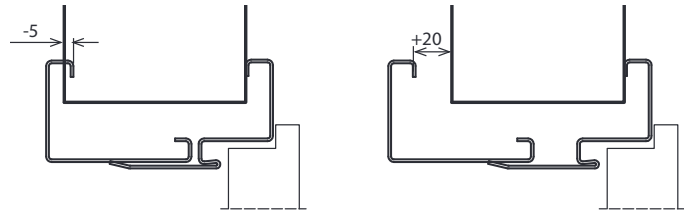

## ADJUSTABLE NON-REBATED FRAME - ADJUSTMENT RANGES

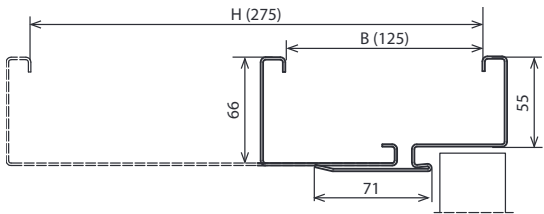

## HOW TO ADJUST ADJUSTABLE NON-REBATED DOOR FRAME

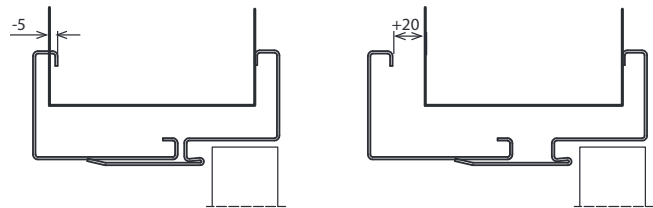

## TECHNICAL INFORMATION

### DOOR FRAME CONSTRUCTION

The adjustable door frame is made out of the best quality galvanized steel, 1,5 mm thick (the Adjustable, Adjustable non-rebated) or 1,2 mm thick (the Adjustable with 'sharp edges').

#### A door frame consists of:

- fixed part mounted on a wall (with hinges and lock strike)
- adjustable part, wrapping the wall
- a rubber seal set circumferentially
- barrel hinges (rebated door frames)
- adjustable 3D hinges (adjustable non-rebated door frame)

### ACCESSORIES INCLUDED IN THE DOOR FRAME PRICE

- Two or three standard barrel hinges (ADJUSTABLE frame)
- Three hinges (size '100' and '110') (ADJUSTABLE frame)
- Two adjustable 3D hinges (ADJUSTABLE NON-REBATED frame)
- An allen key\*
- A rubber seal available in following colours: white, grey, brown, beige, anthracite or black
- Rawlplugs - for a door frame anchored to a concrete wall
- Self-tapping screws - for a door frame anchored to a plasterboard wall

### DOOR FRAME SIZE, SEE PAGE 240, TABLE 2

- '60'; '70'; '80'; '90'; '100'; '110' and '120' ÷ '200'
- To be installed on a finished floor level '0'.

### NOTES

- Technical Assessment ITB-KOT-2017/0245 issue 1.
- Certificate of conformity no. ITB-2617/W, ITB Warsaw
- Door frames should be installed on finished walls (e.g. wall papers) and on a finished floor (e.g. floor panels)
- Polyester Premium paint Anthracite HPL/CPL id dedicated for door leaves finished with HPL/CPL Anthracite
- Size '80' and '90' in the 'Investment Norm' (clear opening width 800, 900 mm) available as a standard - without an extra charge.

### EXTRA CHARGES

- polyester paint: group II
- polyester paint: group III
- adjustable lock strike\*
- investment set\*
- reinforcement for a door closer
- stainless steel threshold
- electric strike: fail-safe or fail secure
- third 3D hinge, silver white, black
- third 3D hinge, gold

\* does not apply to non-rebated frame

# Corner profile Non-rebated, Steel - LARGE

## Corner profile - SMALL PLUS, LARGE

12

### INTERNAL STEEL DOOR FRAMES

Thanks to the highest world standards, the latest technologies and excellent materials we produce galvanized steel or stainless steel door frames.

These are the highest quality products which are often used when robust doors are required.

Thanks to the powder coating process used during production, the surface of the steel sheet is perfectly smooth and protected against corrosion.

#### AVAILABLE FINISHES

Premium polyester paint ★★★★★☆

Group I	White MAT	Grey MAT	Structured anthracite
	Beige MAT	Brown MAT	Anthracite HPL/CPL

Group II	Structured Black
	Black MAT

Finishes charts see page 250 – 257.



Corner profile - LARGE

Corner profile, non-rebated - LARGE

#### DOOR FRAME CROSS SECTION Corner profile steel - SMALL PLUS



#### DOOR FRAME CROSS SECTION Corner profile steel - LARGE



#### DOOR FRAME CROSS SECTION Corner profile non-rebated - LARGE







LONG LASTING DURABILITY



QUALITY GUARANTEED



MODERN DESIGN



EASY INSTALLATION



## DOOR FRAME CROSS SECTION CORNER PROFILE STEEL- SMALL PLUS

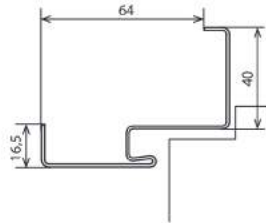

## DOOR FRAME CROSS SECTION CORNER PROFILE - LARGE

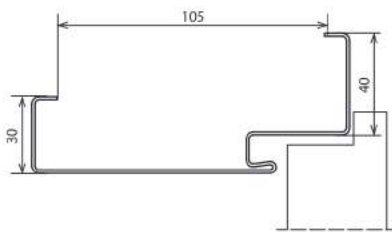

## DOOR FRAME CROSS SECTION CORNER PROFILE NON-REBATED - LARGE

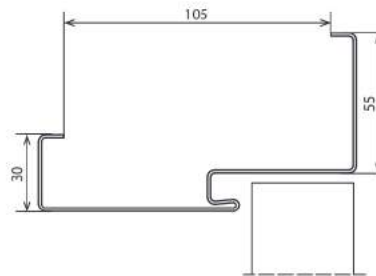

## TECHNICAL INFORMATION

### DOOR FRAME CONSTRUCTION

Corner profile door frames (LARGE, SMALL PLUS and Non-rebated - LARGE) are made out of galvanized steel, 1,2 mm thick. They are available as reversible\* door frames or as right/left door frames. Profile width: 64 mm (SMALL PLUS) and 105 mm (LARGE, Non-rebated LARGE).

### ACCESSORIES INCLUDED IN THE DOOR FRAME PRICE

#### 'LARGE', 'SMALL PLUS':

- Two or three standard barrel hinges
- Three hinges (size '100' and '110')
- An allen key
- A rubber seal set circumferentially. Colours: white, grey, brown, beige, anthracite and black
- Special anchors to ease an installation (SMALL PLUS)

#### 'LARGE' for plasterboard walls:

- Two or three standard barrel hinges
- Three hinges (size '100' and '110')
- An allen key
- A rubber seal available in following colours: white, grey, brown, beige, anthracite and black
- Special anchors to ease an installation (max. for a wall width 150 mm)

#### Non-rebated, LARGE'

- Two adjustable 3D hinges
- A rubber seal available in following colours: white, grey, brown, beige, anthracite and black

### DOOR FRAME SIZE, SEE PAGE 240, TABLE 2

- '60', '70', '80', '90', '100', '110' and '120' ÷ '200'

#### Two options:

- To be installed on a finished floor level - '0'
- To be installed under floor level - '-30'

### NOTES

- Technical Assessment ITB-KOT-2017/0245 issue 1.
- Certificate of conformity no. ITB-2617/W, ITB Warsaw
- Polyester Premium paint Anthracite HPL/CPL id dedicated for door leaves finished with HPL/CPL Anthracite

### EXTRA CHARGES

- polyester paint: GROUP II
- polyester paint: GROUP III
- adjustable lock strike (LARGE)
- dowel pins (LARGE)
- investment set\*
- door frame profile extension from 110 to 150 mm
- door frame profile extension from 155 mm to 270 mm
- door frame profile extension from 275 to 390 mm
- reinforcement for a door closer
- third 3D hinge silver, white, black
- third 3D hinge, gold
- stainless steel threshold
- electric strike: fail secure or fail-safe

(see p. 234)  
(see p. 234)

\* does not apply to Non-rebated door frame - 'LARGE'

# PROJECT BIS, PROJECT Premium®

® Porta proprietary solution, all rights reserved

12

## DOOR FRAME COVER FOR APARTMENT ENTRANCE DOORS.

Considering aesthetically pleasing design of various rooms, we have complemented our offer with PROJECT BIS and PROJECT Premium steel door frame covers.

Thanks to a specially designed profile of a steel door frame, the cover can be easily installed. Covers match the door leaf and facades.

### AVAILABLE FINISHES

Portasynchro 3D

★★★

Portaperfect 3D

★★★★★

CPL HQ 0,2 mm

Gladstone/Halifax

Finishes charts see page 250 – 257.

### DOOR FRAME - CROSS SECTION DRAWINGS (ILLUSTRATIVE)



**P**  
GALVANIZED SHEET  
PORTA STEEL PRODUCT



PROJECT BIS door frame



PROJECT Premium door frame

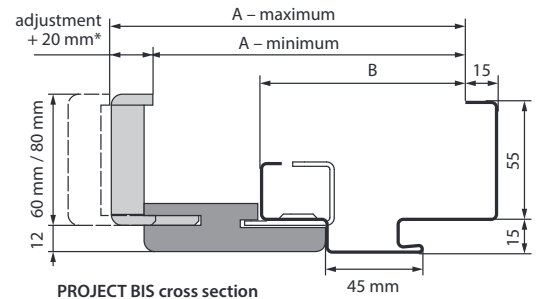

PROJECT BIS cross section

\* for A range, adjustment +15 mm

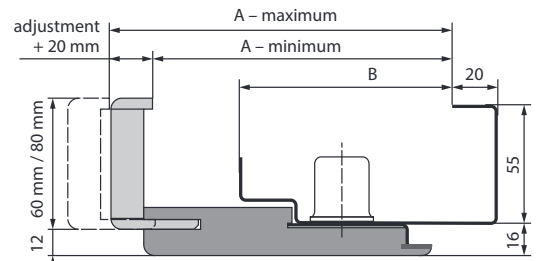

PROJECT Premium cross section

MODELS	PROJECT BIS		PROJECT PREMIUM	
	A	B	A	B
Rw=27 dB	138 ÷ 363 mm	89 mm	133 ÷ 333 mm	95 mm
Rw=32 dB	138 ÷ 363 mm	89 mm	133 ÷ 333 mm	95 mm
AGATE, OPAL	138 ÷ 363 mm	89 mm	133 ÷ 333 mm	95 mm
QUARTZ	138 ÷ 363 mm	89 mm	133 ÷ 333 mm	95 mm
Granite kl. C	143 ÷ 368 mm	94 mm	138 ÷ 338 mm	100 mm
EI 30	143 ÷ 368 mm	94 mm	138 ÷ 338 mm	100 mm
Granite RC 3, Extreme RC 2, RC 3	147 ÷ 372 mm	98 mm	142 ÷ 342 mm	104 mm
Silence 37 dB, rebated	147 ÷ 372 mm	98 mm	142 ÷ 342 mm	104 mm
Silence 37 dB, non-rebated	164 ÷ 389 mm	115 mm	159 ÷ 359 mm	121 mm
Rw=42 dB	162 ÷ 387 mm	113 mm	157 ÷ 357 mm	119 mm
EI 60	155 ÷ 380 mm	106 mm	-	-



LONG LASTING DURABILITY



QUALITY GUARANTEED



MODERN DESIGN



EASY INSTALLATION



60 mm



80 mm



ADJUSTMENT



## PROJECT BIS DOOR FRAME COVER

Adjustment range	AGATE, OPAL, QUARTZ, 27 dB, 32 dB	GRANITE, EI 30	Silence 37 dB rebated, Extreme RC2 and RC3	Silence 37 dB non-rebated	Rw = 42 dB	EI 60
A	138 ÷ 153 mm	143 ÷ 158 mm	147 ÷ 162 mm	164 ÷ 179 mm	162 ÷ 177 mm	155 ÷ 170 mm
B	158 ÷ 178 mm	163 ÷ 183 mm	167 ÷ 187 mm	184 ÷ 204 mm	182 ÷ 202 mm	175 ÷ 195 mm
C	183 ÷ 203 mm	188 ÷ 208 mm	192 ÷ 212 mm	209 ÷ 229 mm	207 ÷ 227 mm	200 ÷ 220 mm
D	203 ÷ 223 mm	208 ÷ 228 mm	212 ÷ 232 mm	229 ÷ 249 mm	227 ÷ 247 mm	220 ÷ 240 mm
E	223 ÷ 243 mm	228 ÷ 248 mm	232 ÷ 252 mm	249 ÷ 269 mm	247 ÷ 267 mm	240 ÷ 260 mm
F	243 ÷ 263 mm	248 ÷ 268 mm	252 ÷ 272 mm	269 ÷ 289 mm	267 ÷ 287 mm	260 ÷ 280 mm
G	263 ÷ 283 mm	268 ÷ 288 mm	272 ÷ 292 mm	289 ÷ 309 mm	287 ÷ 307 mm	280 ÷ 300 mm
H	283 ÷ 303 mm	288 ÷ 308 mm	292 ÷ 312 mm	309 ÷ 329 mm	307 ÷ 327 mm	300 ÷ 320 mm
I	303 ÷ 323 mm	308 ÷ 328 mm	312 ÷ 332 mm	329 ÷ 349 mm	327 ÷ 347 mm	320 ÷ 340 mm
J	323 ÷ 343 mm	328 ÷ 348 mm	332 ÷ 352 mm	349 ÷ 369 mm	347 ÷ 367 mm	340 ÷ 360 mm
K	343 ÷ 363 mm	348 ÷ 368 mm	352 ÷ 372 mm	369 ÷ 386 mm	367 ÷ 387 mm	360 ÷ 380 mm

## PROJECT PREMIUM DOOR FRAME COVER

Adjustment range	AGAT, OPAL, KWARC, 27 dB, 32 dB	GRANIT, EI 30	EXTREME RC 2, RC 3, Silence 37 dB, przylgowe	Silence 37 dB, bezprzylgowe	Rw=42 dB
B	133 ÷ 153 mm	138 ÷ 158 mm	142 ÷ 162 mm	159 ÷ 179 mm	157 ÷ 177 mm
C	153 ÷ 173 mm	158 ÷ 178 mm	162 ÷ 182 mm	179 ÷ 199 mm	177 ÷ 197 mm
D	173 ÷ 193 mm	178 ÷ 198 mm	182 ÷ 202 mm	199 ÷ 219 mm	197 ÷ 217 mm
E	193 ÷ 213 mm	198 ÷ 218 mm	202 ÷ 222 mm	219 ÷ 239 mm	217 ÷ 237 mm
F	213 ÷ 233 mm	218 ÷ 238 mm	222 ÷ 242 mm	239 ÷ 259 mm	237 ÷ 257 mm
G	233 ÷ 253 mm	238 ÷ 258 mm	242 ÷ 262 mm	259 ÷ 279 mm	257 ÷ 277 mm
H	253 ÷ 273 mm	258 ÷ 278 mm	262 ÷ 282 mm	279 ÷ 299 mm	277 ÷ 297 mm
I	273 ÷ 293 mm	278 ÷ 298 mm	282 ÷ 302 mm	299 ÷ 319 mm	297 ÷ 317 mm
J	293 ÷ 313 mm	298 ÷ 318 mm	302 ÷ 322 mm	319 ÷ 339 mm	317 ÷ 337 mm
K	313 ÷ 333 mm	318 ÷ 338 mm	322 ÷ 342 mm	339 ÷ 359 mm	337 ÷ 357 mm

**K** Covers in natural veneer available through Porta CONTRACT

## TECHNICAL INFORMATION

## DOOR FRAME CONSTRUCTION

**Complete PROJECT BIS and PROJECT BIS PREMIUM door frames consist of:**

- corner profile steel door frame, made out of galvanized steel 1,2 thick (AGATE) or 1,5 mm thick (OPAL, QUARTZ, EXTREME RC2, RC3, GRANITE class C, Rw=27 dB, Rw=32 dB, Silence Rw=37 dB, Rw=42 dB, EI 30, EI 60), with a special profile for PROJECT covers
- specially milled elements, consisting of a head beam and two jambs and architraves made of wood-based materials
- PROJECT covers are produced and delivered as a set of elements to be assembled on site.

## ACCESSORIES INCLUDED IN THE DOOR FRAME PRICE

- Standard accessories, depending on type of door frame and type of door leaf.

## DOOR FRAME SIZE, SEE PAGE 240, TABLE 2

• '80'; '90'; '100'

**Two options:**

- To be installed on a finished floor level - '0'
- To be installed under floor level - '-30'

## NOTES

- Technical Assessment ITB-KOT-2017/0245 issue 1.
- Certificate of conformity no. ITB-2617/W, ITB Warsaw
- Minimum wall thickness - 'A' range
- A project door frame requires wall opening to be enlarged  $S_0 + 30$  mm ( $\pm 10$ ) and  $H_0 + 15$  ( $\pm 5$ ) in comparison to STD sizes of steel door frames, see page 209, Table 3.

## EXTRA CHARGES

- Door frame cover - CPL 0,2 mm finish - GROUP II



# ACCESSORIES, DIMENSIONS & ADDITIONAL INFORMATION

At PORTA, we also offer a wide selection of door handles and accessories. These have been designed by our experts to complement your Porta Door.

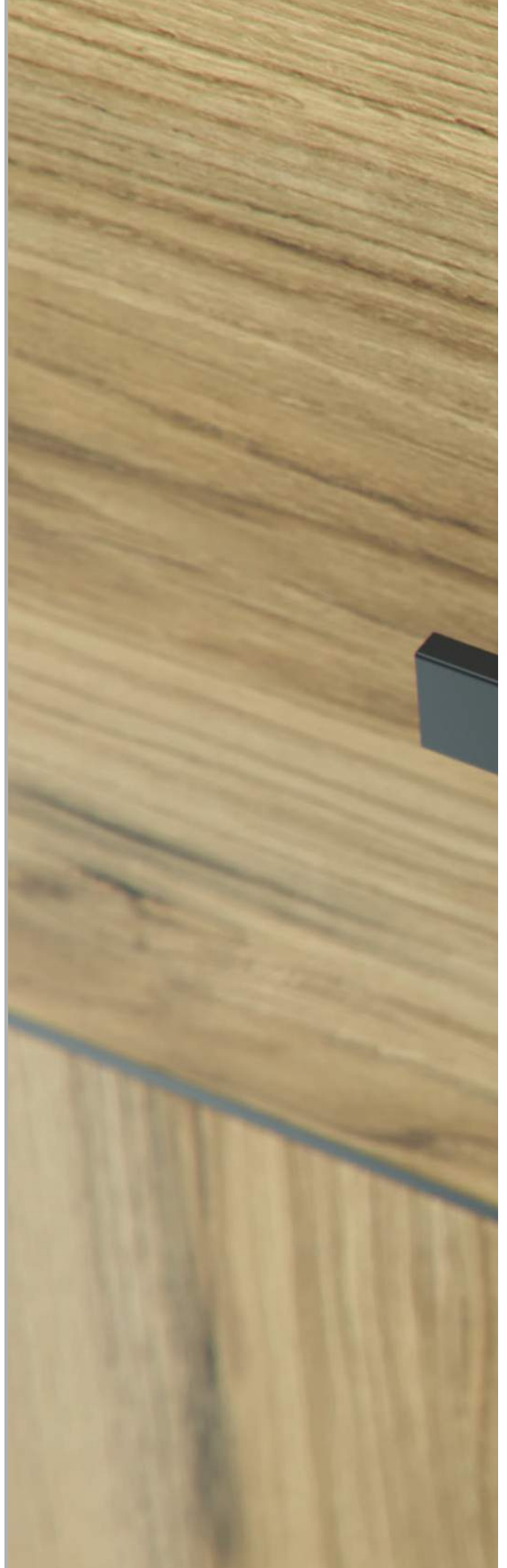

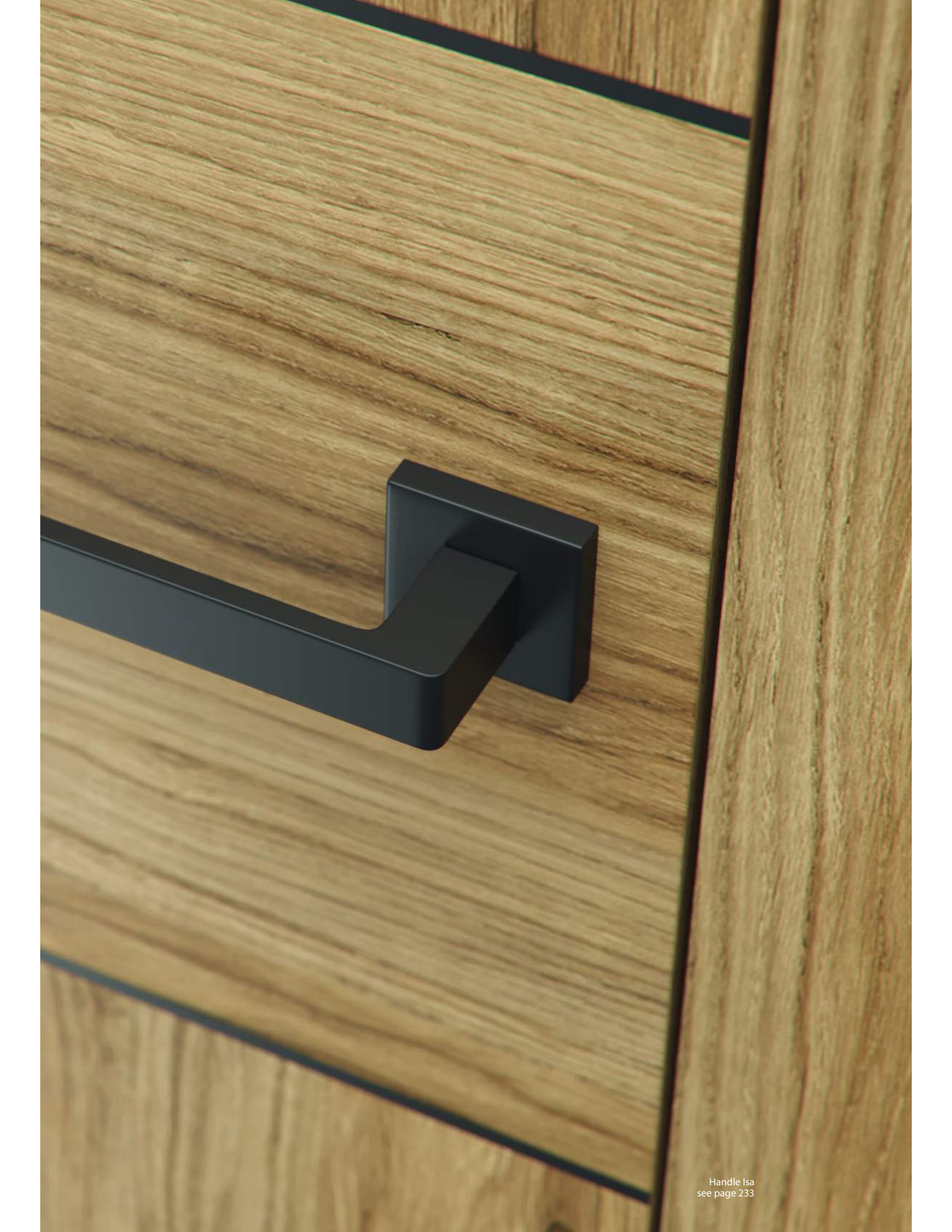

Handle Isa  
see page 233

# AZURA Collection

Due to printing technology, the colour of presented products in the catalogue may slightly differ from the actual product.

## DISCOVER THE NEW AZURA COLLECTION

Azura collection, consisting of door and furniture accessories, allows customers to add a unique atmosphere and coherent character to their interior design.

The set includes a door handle, es-cutcheon, door stops, as well as a wide selection of furniture handles and a wall hanger.

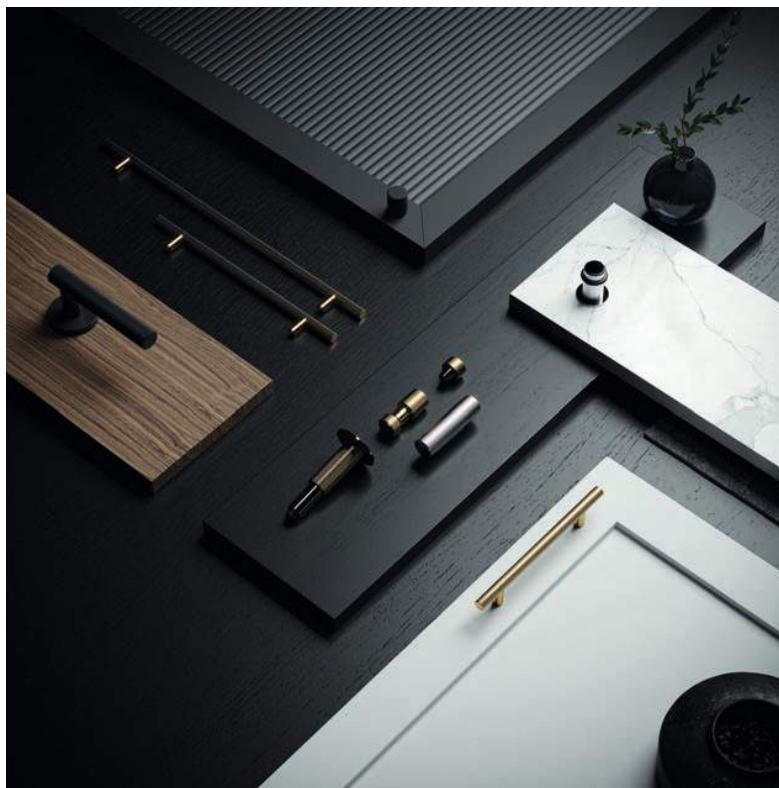

See more:

[www.porta.com.pl/azura](http://www.porta.com.pl/azura)

### AZURA BLACK



Handle

260 | **319.80**



WC escutcheon

79 | **97.17**



320 mm handle

78 | **95.94**



192 mm handle

57 | **70.11**



128 mm handle

45 | **55.35**



T-bar handle

45 | **55.35**



Cone knob

37 | **45.51**



Cylinder knob

25 | **30.75**



Wall stop

60 | **73.80**



Floor stop

50 | **61.50**



Hanger

37 | **45.51**

# AZURA Collection

Due to printing technology, the colour of presented products in the catalogue may slightly differ from the actual product.

## AZURA GOLD



Handle | 295 | **362.85**



WC escutcheon | 96 | **118.08**



320 mm handle | 86 | **105.78**



192 mm handle | 66 | **81.18**



128 mm handle | 53 | **65.19**



T-bar handle | 70 | **86.10**



Cone knob | 45 | **55.35**



Cylinder knob | 33 | **40.59**



Wall stop | 75 | **92.25**



Floor stop | 55 | **67.65**



Hanger | 40 | **49.20**

## AZURA SILVER



Handle | 260 | **319.80**



WC escutcheon | 79 | **97.17**



320 mm handle | 84 | **103.32**



192 mm handle | 61 | **75.03**



128 mm handle | 49 | **60.27**



T-bar handle | 61 | **75.03**



Cone knob | 45 | **55.35**



Cylinder knob | 33 | **40.59**



Wall stop | 65 | **79.95**



Floor stop | 50 | **61.50**



Hanger | 37 | **45.51**

\*Wartości wskazane przy uchwytach meblowych podłużnych (320 mm, 192 mm, 128 mm) wskazują na rozstaw śrub montażowych uchwytów.

# Handles

Due to printing technology, the colour of presented products in the catalogue may slightly differ from the actual product.

## ACCENT



Handle  
Key lock escutcheon,  
Euro cylinder escutcheon  
WC escutcheon

silver

silver matt

golden matt



## MODERN



Handle  
Key lock escutcheon,  
Euro cylinder escutcheon  
WC escutcheon

silver

silver matt

golden matt



## NEXT



Handle  
Key lock escutcheon,  
Euro cylinder escutcheon  
WC escutcheon

silver

silver matt

golden matt



## OFFICE



Handle  
Key lock escutcheon,  
Euro cylinder escutcheon  
WC escutcheon

silver

silver matt

golden matt

golden matt



anthracite



## CARO



Handle  
Key lock escutcheon,  
Euro cylinder escutcheon  
WC escutcheon

silver

silver matt

golden matt





# Handles

Due to printing technology, the colour of presented products in the catalogue may slightly differ from the actual product.

## ROYAL



brushed silver

antique gold

Handle  
Key lock escutcheon,  
Euro cylinder escutcheon  
WC escutcheon

## ELEGANT

**WE RECOMMEND** A Modern thin escutcheon is a class of its own.



silver



white



black



Handle  
Key lock escutcheon,  
Euro cylinder escutcheon  
WC escutcheon

## SIMPLE

**WE RECOMMEND** A Modern thin escutcheon is a class of its own.



silver



white



black



Handle  
Key lock escutcheon,  
Euro cylinder escutcheon  
WC escutcheon

## GAMET

### UNICO



structured black



structured anthracite



Handle  
Key lock escutcheon,  
Euro cylinder escutcheon  
WC escutcheon

### ORGANIC



structured black



structured anthracite



Handle  
Key lock escutcheon,  
Euro cylinder escutcheon  
WC escutcheon

# Handles

Due to printing technology, the colour of presented products in the catalogue may slightly differ from the actual product.

## TOPAZ



stainless steel

Handle  
Key lock escutcheon,  
Euro cylinder escutcheon  
WC escutcheon



## EUFORIA Q



black

Handle  
Key lock escutcheon,  
Euro cylinder escutcheon  
WC escutcheon

## EUFORIA



black

The door handle and the WC knob feature an antimicrobial coating containing active silver ions



## BARCELONA



chrome



nickel



black

Handle  
Key lock escutcheon,  
Euro cylinder escutcheon  
WC escutcheon



## RUMBA



chrome



nickel



black

Handle  
Key lock escutcheon,  
Euro cylinder escutcheon  
WC escutcheon



## SUPRA Q

NEW



black

Handle  
Key lock escutcheon,  
Euro cylinder escutcheon  
WC escutcheon



# Handles

Due to printing technology, the colour of presented products in the catalogue may slightly differ from the actual product.

**SUPRA R** NEW



black

Handle  
Key lock escutcheon,  
Euro cylinder escutcheon  
WC escutcheon



**LUNA**



gold



chrome



brushed chrome



black

Handle  
Key lock escutcheon,  
Euro cylinder escutcheon  
WC escutcheon



**CUBE**



brushed nickel matt



brushed chrome matt



black

Handle  
Key lock escutcheon,  
Euro cylinder escutcheon  
WC escutcheon



**BELLA SLIM**

**WE RECOMMEND** A Modern thin escutcheon is a class of its own.



brushed chrome matt



gold



black

Handle  
Key lock escutcheon,  
Euro cylinder escutcheon  
WC escutcheon



**KNOB Q SLIM** NEW



black

Knob  
Key lock escutcheon,  
Euro cylinder escutcheon  
WC escutcheon



# Handles

Due to printing technology, the colour of presented products in the catalogue may slightly differ from the actual product.

## Metal-Bud

### MAXIMA



chrome



brushed chrome



black



Handle  
Key lock escutcheon,  
Euro cylinder escutcheon  
WC escutcheon

### MAXIMA CONNECT

NEW



czarna z białym insertem



Handle  
Key lock escutcheon,  
Euro cylinder escutcheon  
WC escutcheon

### PRISMA



chrome



black



Handle  
Key lock escutcheon,  
Euro cylinder escutcheon  
WC escutcheon



### LEA

NEW



gold



black



Handle  
Key lock escutcheon,  
Euro cylinder escutcheon  
WC escutcheon

### RONDA

NEW



gold matt



black



Handle  
Key lock escutcheon,  
Euro cylinder escutcheon  
WC escutcheon

# Handles

Due to printing technology, the colour of presented products in the catalogue may slightly differ from the actual product.



## ■ BRAVA



chrome



brushed chrome



black



Handle  
Key lock escutcheon,  
Euro cylinder escutcheon  
WC escutcheon

## ■ JULIA



chrome



Handle  
Key lock escutcheon,  
Euro cylinder escutcheon  
WC escutcheon

## ■ DIVO FIT

**WE RECOMMEND** A Modern thin escutcheon is a class of its own.



chrome



brushed chrome



black



Handle  
Key lock escutcheon,  
Euro cylinder escutcheon  
WC escutcheon

## ■ DIVO FIT Q

**WE RECOMMEND** A Modern thin escutcheon is a class of its own.



chrome



satine chrome



black



Handle  
Key lock escutcheon,  
Euro cylinder escutcheon  
WC escutcheon



## ■ LEA LUX



chrome



black



Handle  
Key lock escutcheon,  
Euro cylinder escutcheon  
WC escutcheon

# Handles

Due to printing technology, the colour of presented products in the catalogue may slightly differ from the actual product.

## APRILE

### AZALIA



Handle  
Key lock escutcheon,  
Euro cylinder escutcheon  
WC escutcheon

### LILA



Handle  
Key lock escutcheon,  
Euro cylinder escutcheon  
WC escutcheon

### ORTICA

NEW



Handle  
Key lock escutcheon,  
Euro cylinder escutcheon  
WC escutcheon

### LUCIA PROF SMART2LOCK

NEW

handle with an automatic bolting mechanism



# Handles

Due to printing technology, the colour of presented products in the catalogue may slightly differ from the actual product.

## Handles obiektowe

### STERK

#### ■ OVAL / class 4



Handle

stainless steel



Key lock escutcheon



Euro cylinder escutcheon



WC escutcheon

#### ■ KVADRAT / class 4



Handle

stainless steel



Key lock escutcheon



Rozeta Euro cylinder escutcheon



WC escutcheon



#### ■ UNO 3S / class 3



Handle

stainless steel

**WE RECOMMEND** A Modern thin escutcheon is a class of its own.



Key lock escutcheon



Rozeta Euro cylinder escutcheon



WC escutcheon

#### ■ DUE 3S / class 3



Handle

stainless steel

**WE RECOMMEND** A Modern thin escutcheon is a class of its own.



Key lock escutcheon



Rozeta Euro cylinder escutcheon



WC escutcheon

#### ■ EDEL / class 3



Handle

stainless steel



Euro cylinder escutcheon WC escutcheon

#### ■ MINI PLUS



Handle (72) plastic

black (key lock, euro cylinder)

MINI PLUS

25 | 30,75

# Handles

Due to printing technology, the colour of presented products in the catalogue may slightly differ from the actual product.

## MIRO

this product is dedicated only for AGAT doors

Handle (72)	standard	escutcheon for upper lock
-------------	----------	---------------------------

brushed nickel, black



**Metal-Bud**

## PORTA AGAT (I ST EUROPEAN CLASS)

Handle (72)	standard	with a knob	escutcheon for upper lock
-------------	----------	-------------	---------------------------

silver

black



**NEW**



**VS**  
LADNE KLAMKI

## PORTA AGAT PLUS (I ST EUROPEAN CLASS)

Handle (72)	standard	with a knob	escutcheon for upper lock
-------------	----------	-------------	---------------------------

inox



**FKS**

## PORTA OPAL (II ND EUROPEAN CLASS)

Handle (72)	standard	with a knob	escutcheon for upper lock
-------------	----------	-------------	---------------------------

inox, titanium



**AXA**  
HOME SECURITY

## PORTA OPAL PLUS (II ND EUROPEAN CLASS)

Handle (72)	standard	with a knob	escutcheon for upper lock
-------------	----------	-------------	---------------------------

inox



**FKS**

## PORTA GRANIT (III RD EUROPEAN CLASS, FORMERLY CLASS 'C')

Handle (72)	standard	with a knob	escutcheon for upper lock
-------------	----------	-------------	---------------------------

inox, titanium





**AXA**  
HOME SECURITY



# Handles

Due to printing technology, the colour of presented products in the catalogue may slightly differ from the actual product.



## PORTA GRANIT PLUS (III RD EUROPEAN CLASS)

Handle (72)	standard	with a knob	escutcheon for upper lock
inox, titanium			
 inox	 titanium		



**AXA**  
HOME SECURITY



## ROYAL (III RD EUROPEAN CLASS)

Handle (72)	standard	with a knob	escutcheon for upper lock
inox			
black			
 inox	 black		



**AXA**  
HOME SECURITY

## PORTA SAFE (III RD CLASS)

Handle (92)	standard	with a knob	escutcheon for upper lock
inox, titanium			
black			
 inox	 titanium	 black	



**AXA**  
HOME SECURITY

## PULLS

for external doors

stainless steel



inox and titanium

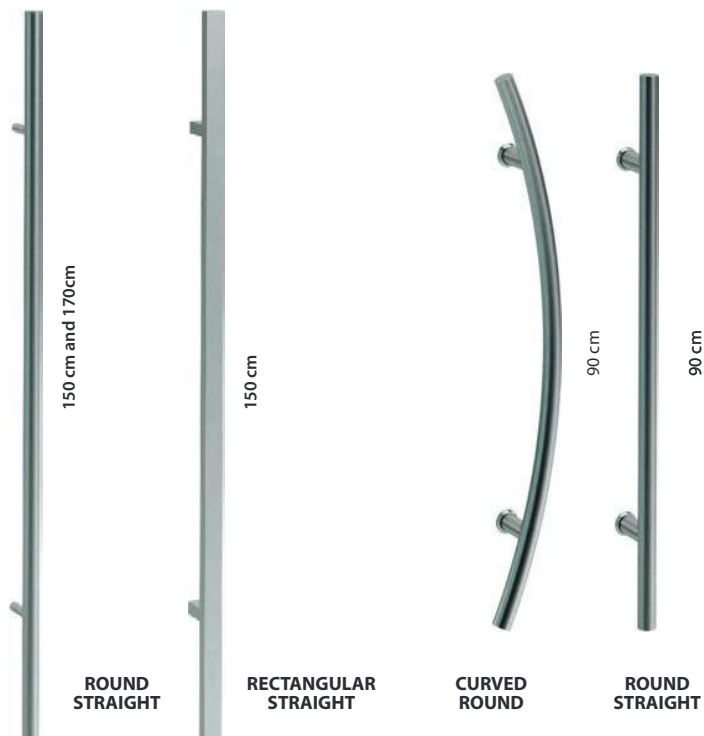
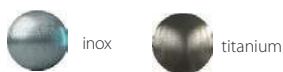

ROUND  
STRAIGHT

RECTANGULAR  
STRAIGHT

CURVED  
ROUND

ROUND  
STRAIGHT



# Additional accessories

## DOOR HANDLE PLATES

NEW



rectangular plate



round plate



oval plate

## STAINLESS STEEL PORTHOLE



- Porthole is available only with door leaves with hollow chipboard core for following solid models: MINIMAX, Porta DECOR, Porta CPL, ENDURO, NatureCLASSIC, Porta RESIST
- Diameter: 350 mm
- Available glass panels: transparent or laminated satin glass panel class 2, 6 mm thick

## ENTRANCE DOOR HARDWARE



- Two euro cylinders, class B'
- silver, golden

## THRESHOLD



Stainless steel threshold, compatible with Porta door frames:

- standard (90 mm)
- widened (120 mm)

for double door leaves

- standard (90 mm)
- widened (120 mm)

## DOOR CLOSER



DOOR CLOSER

- available finishes: silver and brown

## ADDITIONAL HARDWARE



Hook lock, key or WC with side and front pulls.  
For sliding doors.

- Available in following colours: golden, matt gold, silver, matt silver



Round pull handle for sliding

- doors- for the price of a door leaf.
- colours: silver and gold

## ELECTRIC STRIKES



Electric strike for steel door frame Angular, LARGE and Adjustable:

- obverse
- reverse



Electric strike for the PORTA SYSTEM door frame:

- obverse
- reverse

## PREPARATION FOR SHORTENING



Rectangular and longitudinal door pulls for sliding doors.

- colours: gold, matte gold, silver, matte silver, black



Preparation for shortening the door leaf

- maximum 60 mm

# Additional accessories

## LOCKS



Magnetic lock with stainless steel face plate  
 • for rebated and non-rebated doors  
 Adjustable strike plate for non-rebated doors.  
 We suggest choosing matt silver hinges.



PRIME lock with gold or silver face plate.  
 • models finished with synthetic veneer lock latch - matt galvanized

NEW



Lock with black face plate.  
 (not available in the patent version)

## HINGES



3D hinges. Door part, frame part.

- golden
- silver, white, black



PRIME barrel hinges.  
 Door part, frame part.  
 • golden, matt gold, silver, matt silver



Standard barrel hinges.  
 Door part, frame part.  
 • silver



Standard barrel hinges.  
 Door part, frame part.  
 • black



Check how to adjust hinges



Adjustable barrel hinges 3D.  
 Door part, door frame part.  
 • silver

SUPER PRICE

## NAKLADKI



Standard hinges caps for internal doors (a set for one hinge)  
 • golden, matt silver, gloss chrome, white, black



Villadora hinges caps (a set for one hinge)  
 • golden gloss, old gold, silver gloss

# Additional accessories

## ■ BLUESMART ELECTRONIC HANDLE

Communication is effected by means of identification cards, blueSmart keys or authorised key rings. Electronic handle is available for internal, acoustic and fire-rated doors – internal use. Escutcheons are available in two colours – white (RAL 9003) and black (RAL 9005).

**Other options and detailed information - check DOWNLOADS tab at [www.portadoors.com](http://www.portadoors.com)**



white (RAL 9003)



black (RAL 9005)

Electronic handle  
blueSmart system

Two or one side cylinder  
electronic control

User's passive key  
colour

## PORTA DOOR CARE NEW

a set for cleaning, refreshing and regenerating of door surfaces.



Regular use of the preparations ensures that the doors are kept clean and in perfect condition, guaranteeing the highest level of satisfaction. It is recommended to use regularly every 2-3 weeks, in case of intensive dirt more often, and in the meantime wipe the door with a soft and dry cloth, without using additional cleaning agents.

THE SET COMPRISES:

**PORTA Door Cleaner** – a preparation for door surfaces cleaning.

A preparation for thorough cleaning of all types of door surface. It does not change gloss. It removes traces after grease, stickers, waxes, pens, pencils, markers, shoepaste, nicotine, etc.

Antistatic agent.

**PORTA Door Refresher** – a preparation for refreshing and regenerating of door surface.

A preparation for refreshing and regenerating of all types of natural wood, veneer, board and varnished modern and stylized door surfaces. It removes grey stains after water and alcohol. It enlivens colour and restores original appearance of door surface. Do not use for high gloss, waxed or oiled door surfaces.

It does not contain wax or silicone.

# Architraves and ventilation

## ARCHITRAVES



flat architraves



rounded architraves



quarterrounds  
(2,15 m x 12 mm x 22 mm)

Portadecor,  
Portasynchro 3D

Portaperfect 3D

Portadur, CPL HQ,  
Portalamino

Premium veneer,  
Gladstone/Halifax

UV acrylic paint

Natural veneer

## SKIRTING BOARDS

NEW

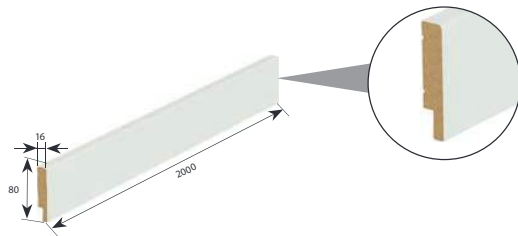

### FINIHSES

Portadecor: white, unvarnished,  
UV acrylic paint: white and grey,  
Portaperfect 3D: Natural oak, CPL  
HQ: black

## WALL SLATES

NEW

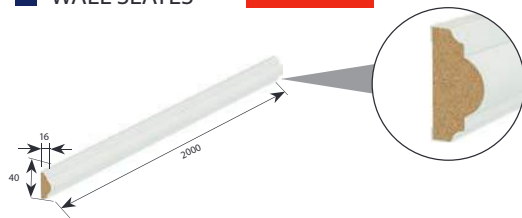

## VENTILATION SLEEVES



Ventilation sleeves  
• 1 row (various colours)



Ventilation sleeves  
• 2 rows (various colours)



Ventilation undercut



Ventilation slit



Sale of steel ventilation sleeves, retail  
(per item)

- Available colours:
  - square sleeves: gold, matte gold, silver, matte silver
  - round sleeves: silver, matte silver



Ventilation grille with a mounting frame (different colours)

- This ventilation grille meets the building law regulations
  - regarding bathroom ventilation.

# Technical drawings

## POLISH NORM (PN)

### ■ OPTIONS OF INSTALLATION - MINIMAX DOOR FRAMES

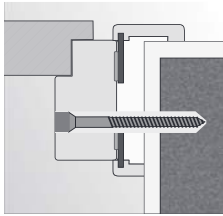

installation on a concrete wall with mounting foam and anchors

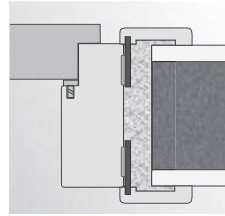

installation on a concrete wall with expanding foam

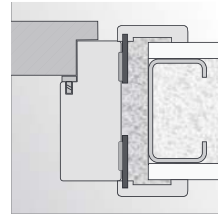

installation on a plasterboard wall with expanding foam

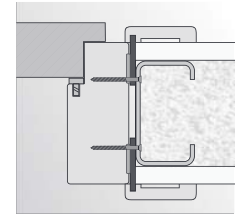

installation on a plasterboard wall with screws

### ■ OPTIONS OF INSTALLATION - CORNER PROFILE DOOR FRAMES

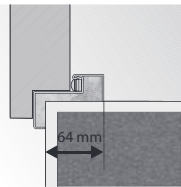

Corner profile door frame - SMALL PLUS

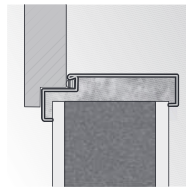

installation without anchoring elements

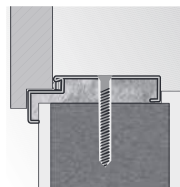

Corner profile door frame - LARGE, installation with dowel pins

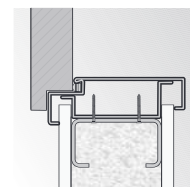

Corner profile door frame - LARGE, installation on a plasterboard wall

### ■ OPTIONS OF INSTALLATION - ADJUSTABLE DOOR FRAME, ADJUSTABLE PS WITH SHARP EDGES'

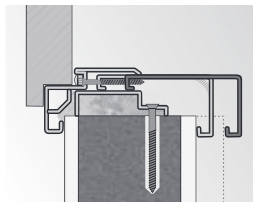

wall thickness      adjustment range

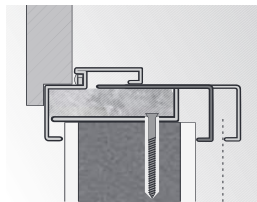

wall thickness      adjustment range

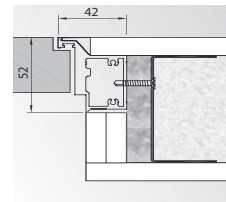

reversed rebate (inward opening)

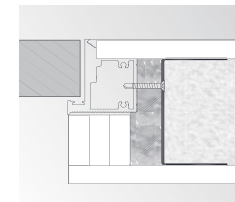

non-rebated (outward opening)

### ■ RETRO MODULE (WITH PORTA SYSTEM DOOR FRAME)

### ■ REBATED DOOR EDGE

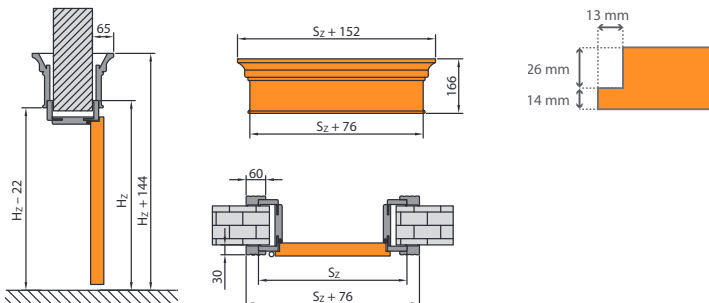

# Door dimensions

■ MINIMAX DOOR FRAME

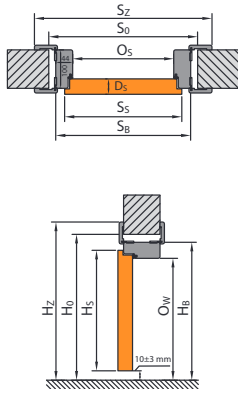

■ PORTA SYSTEM DOOR FRAME

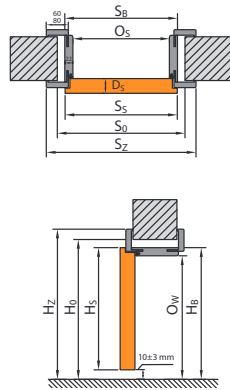

■ PORTA SYSTEM ELEGANCE DOOR FRAME

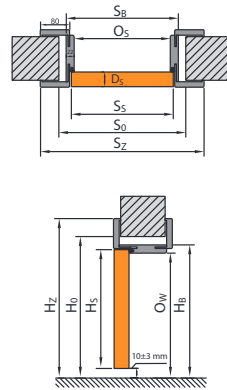

■ LEVEL DOOR FRAME

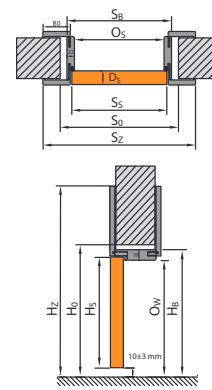

■ DOOR FRAME WITH REVERSED REBATE

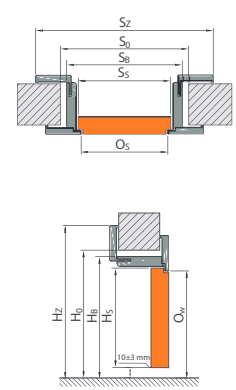

■ STEEL DOOR FRAME

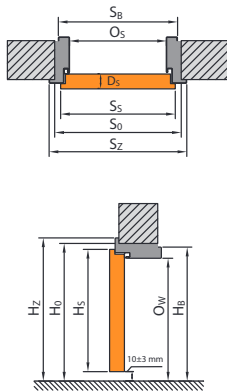

■ NON-REBATED STEEL DOOR FRAME

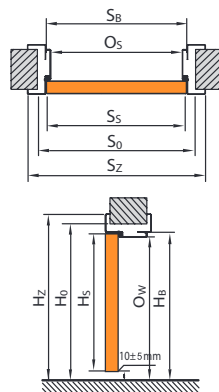

■ PORTA HIDE

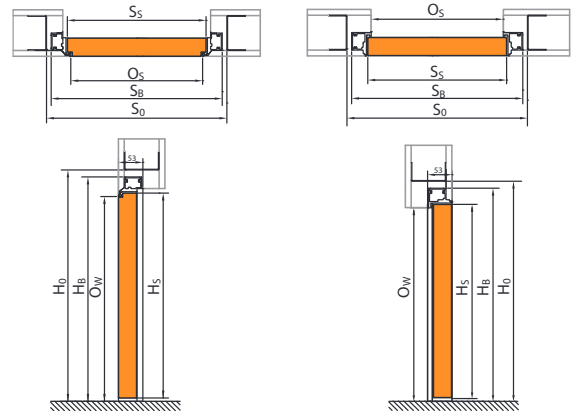

■ PORTA SLIDING SYSTEM

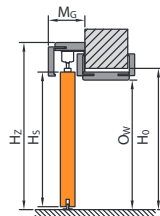
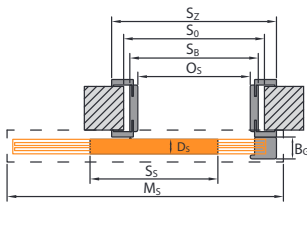

■ COMPACT SLIDING SYSTEM

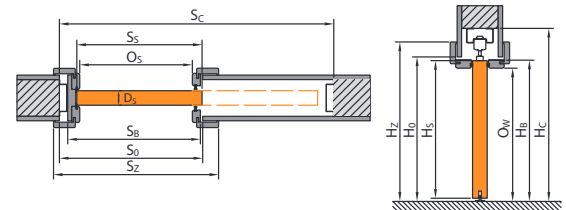

■ FRAMELESS SLIDING SYSTEM

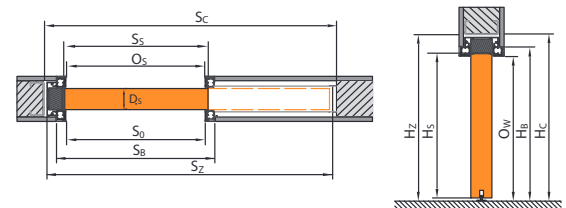

How to measure a wall opening

# Door dimensions tables

## POLISH NORM (PN)

### DIMENSIONS KEY

$S_s$	total door leaf width (including rebates)	$H_b$	door frame height, without architraves
$H_s$	total door leaf height (including rebate)	$S_z$	total door frame width with architraves
$D_s$	door leaf thickness	$H_z$	total height of door frame, including architraves
$S_0$	width of a wall opening prepared for installation	$M_s$	width of sliding door masking system
$H_0$	height of a wall opening prepared for installation, measured from finished floor level	$M_g$	thickness of a rail cover (sliding systems)
$O_s$	opening width (for Alfa and Beta this dimension is decreased by the door leaf thickness)	$B_g$	thickness of a door stop (jamb) (sliding systems)
$O_w$	opening height (measured from finished floor level)	$T_{s/w}$	acceptable width and height tolerance (wall opening)
$S_b$	door frame width without architraves	$S_c$	wall opening width for a metal cassette (pocket door system)
		$H_c$	wall opening height for a metal cassette (pocket door system), (measured from finished floor level)

Refer to architrave 60/80 mm in dimension tables ( $S_s$ ).

### INTERNAL DOORS WITH WOODEN DOOR FRAMES

TABLE 1

Table with dimension for internal double doors you can find on: [www.porta.com.pl/do-pobrania](http://www.porta.com.pl/do-pobrania)

DOOR FRAME TYPE	SIZE	$S_s$	$H_s$	$D_s$	$S_0$	$H_0$	$O_s$	$O_w$	$S_b$	$H_b$	$S_z$ (6)	$S_z$ (8)	$H_z$	$T_{s/w}$
Minimax 60 mm, Minimax 100 mm, MDF in natural veneer	60	644	2030	40	710	2075	602	2016	690	2060	800	-	2115	+20 / +10
	70	744			810		702		790		900	-		
	80	844			910		802		890		1000	-		
	90	944			1010		902		990		1100	-		
	100	1044			1110		1002		1090		1200	-		
Porta SYSTEM	60	644	2030	40	680	2060	602	2016	646	2038	746	786	architrave (6) / (8) 2088 / 2108	+20 / +10
	70	744			780		702		746		846	886		
	80	844			880		802		846		946	986		
	90	944			980		902		946		1046	1086		
	100	1044			1080		1002		1046		1146	1186		
Porta SYSTEM ELEGANCE LEVEL	60	618	2017	40	690	2060 / 2070	602	2016	646	2038 / 2046	-	786	2108 / top panel (20) / (100) 2228 / 3028	+10 / +10
	70	718			790		702		746		-	886		
	80	818			890		802		846		-	986		
	90	918			990		902		946		-	1086		
	100	1018			1090		1002		1046		-	1186		
Porta SYSTEM ELEGANCE 90 degrees	60	618	2017	40	690	2060	602	2016	646	2038	-	786	2108	+10 / +10
	70	718			790		702		746		-	886		
	80	818			890		802		846		-	986		
	90	918			990		902		946		-	1086		
	100	1018			1090		1002		1046		-	1186		
Porta SYSTEM with reversed rebate*	60	639	2027	40	720	2080	626	2028	691	2061	-	831	2130	±10/±5
	70	739			820		726		791		-	931		
	80	839			920		826		891		-	1031		
	90	939			1020		926		991		-	1131		
	100	1039			1120		1026		1091		-	1231		
RENOVA**	60	644	2030	40	596	2016	558	1994	584	2007	746	-	2088	+15 / -6
	70	744			696		658		684		-	-		
	80	844			796		758		784		-	-		
	90	944			896		858		884		-	-		
	100	1044			996		958		984		-	-		
Villadora RETRO	60	644	2030	40	680	2060	602	2016	646	2038	-	789	2110	+20 / +10
	70	744			780		702		746		-	889		
	80	844			880		802		846		-	989		
	90	944			980		902		946		-	1089		
	100	1044			1080		1002		1046		-	1189		

NOTE:  $S_z$  and  $H_z$  dimensions of door frame in natural veneers are given with tolerance -1 mm / + 3 mm.

\*Dimension  $S_s$  and  $H_s$  measured on the wider side of the door leaf. They are the same as dimensions of doors with PSE

\*\* $S_0/H_0$  width/height of clear opening of old steel frame.  $T_{s/w}$  - tolerance +15 mm depends on a construction of the old door frame



# Door dimensions tables

POLISH NORM (PN)

## INTERNAL DOORS WITH STEEL DOOR FRAMES

TABLE 2

DOOR FRAME TYPE	SIZE	S <sub>s</sub>	H <sub>s</sub>	D <sub>s</sub>	S <sub>o</sub>	H <sub>o</sub>	O <sub>s</sub>	O <sub>w</sub>	S <sub>b</sub>	H <sub>b</sub>	S <sub>z</sub>	H <sub>z</sub>	T <sub>sw</sub>
Corner profile door frame - SMALL PLUS	60	644	2030	40	649	2043	596	2016	629	2033	706	2071	±10/±5
	70	744			749		696		729		806		
	80*	844			849		796		829		906		
	90*	944			949		896		929		1006		
	100	1044			1049		996		1029		1106		
Corner profile door frame - LARGE for concrete walls and stainless steel LARGE folding	60	644	2030	40	675	2055	596	2016	656	2046	706	2071	±10/±5
	70	744			775		696		756		806		
	80*	844			875		796		856		906		
	90*	944			975		896		956		1006		
	100	1044			1075		996		1056		1106		
	110	1144			1175		1096		1156		1206		
Corner profile door frame - LARGE, plasterboard walls	60	644	2030	40	685	2055	596	2016	680	2046	706	2071	+10/+5
	70	744			785		696		780		806		
	80*	844			885		796		880		906		
	90*	944			985		896		980		1006		
	100	1044			1085		996		1080		1106		
	110	1144			1185		1096		1180		1206		
Adjustable steel door frame	60	644	2030	40	690	2063	596	2016	670	2053	716	2076	-10/-5
	70	744			790		696		770		816		
	80*	844			890		796		870		916		
	90*	944			990		896		970		1016		
	100	1044			1090		996		1070		1116		
	110	1144			1190		1096		1170		1216		
Adjustable PS with ,sharp edges'	60	644	2030	40	700	2070	596	2016	679	2058	736	2086	-10/-5
	70	744			800		696		779		836		
	80*	844			900		796		879		936		
	90*	944			1000		896		979		1036		
	100	1044			1100		996		1079		1136		
Steel Porta SYSTEM	60	644	2030	40	675	2055	596	2016	646	2041	736	2086	±10/±5
	70	744			775		696		746		836		
	80*	844			875		796		846		936		
	90*	944			975		896		946		1036		
	100	1044			1075		996		1046		1136		
Steel Porta SYSTEM ELEGANCE**	60	618	2017	40	676	2056	596	2016	646	2041	736	2086	±10/±5
	70	718			776		696		746		836		
	80	818			876		796		846		936		
	90	918			976		896		946		1036		
Corner profile non-rebated - LARGE for concrete walls**	60	618	2017	40	676	2056	596	2016	656	2046	736	2086	±10/±5
	70	718			776		696		756		836		
	80	818			876		796		856		936		
	90	918			976		896		956		1036		
	100	1018			1076		996		1056		1136		
Corner profile non-rebated - LARGE for plasterboard walls**	60	618	2017	40	681	2056	596	2016	656	2046	736	2086	+10/+5
	70	718			781		696		756		836		
	80	818			881		796		856		936		
	90	918			981		896		956		1036		
	100	1018			1081		996		1056		1136		
Adjustable, non-rebated steel door frame	60	618	2017	40	690	2063	596	2016	670	2053	736	2086	-10/-5
	70	718			790		696		770		836		
	80	818			890		796		870		936		
	90	918			990		896		970		1036		
	100	1018			1090		996		1070		1136		
110	1118	1190	1096	1170	1236								

**\*NOTE!** Investment norm (clear opening width 800,900 mm) is available as a standard without an extra charge - add 8 mm to S0 dimension.

Please, remember to order suitable size of door leaves which are dedicated for the set.

\*\*If the back of the hinge does not fit in a wall opening, a little wall chasing has to be made.

# Door dimensions tables

POLISH NORM (PN)

TECHNICAL DOORS

TABLE 3

DOOR FRAME TYPE	SIZE	S <sub>s</sub>	H <sub>s</sub>	D <sub>s</sub>	S <sub>0</sub>	H <sub>0</sub>	O <sub>s</sub>	O <sub>w</sub>	S <sub>b</sub>	H <sub>b</sub>	S <sub>2</sub> (6)	S <sub>2</sub> (8)	H <sub>2</sub>	T <sub>s/rw</sub>
Rw=27 dB with Porta SYSTEM door frame	60	644	2030	40	680	2060	602	2016	646	2038	746	786	architrave (6) / (8) 2088 / 2108	+20 / +10
	70	744			780		702		746		846	886		
	80	844			880		802		846		946	986		
	90	944			980		902		946		1046	1086		
	100	1044			1080		1002		1046		1146	1186		
Rw=32 dB with Porta SYSTEM door frame	60	644	2030	44	680	2060	602	2016	650	2040	746	786	architrave (6) / (8) 2088 / 2108	+20 / +10
	70	744			780		702		750		846	886		
	80	844			880		802		850		946	986		
	90	952			988		910		958		1054	1094		
	100	1044			1080		1002		1050		1146	1186		
Porta SILENCE Rw=37 dB adjustable rebated	80	844	2030	49 / 50	880	2060	802	2016	850	2040	946	986	2088/2108	+20 / +10
	90	968			1004		926		974		1070	1110		
	100	1044			1080		1002		1050		1146	1186		
Porta SILENCE Rw=37 dB adjustable non-rebated	80	818	2017	49 / 50	880	2060	801	2016	849	2040	-	985	- / 2108	+20 / +10
	90	968			1030		951		999		-	1135		
	100	1018			1080		1001		1049		-	1185		
Porta SILENCE Rw=37 dB fixed rebated	80	844	2030	49 / 50	950	2090	802	2017	922	2077	1024	1064	2128/2148	±10 / ±5
	90	968			1074		926		1046		1148	1188		
	100	1044			1150		1002		1122		1224	1264		
Porta SILENCE Rw=37 dB fixed non-rebated	80	818	2017	49 / 50	950	2090	801	2017	921	2077	-	1063	- / 2148	±10 / ±5
	90	968			1100		951		1071		-	1213		
	100	1018			1150		1001		1121		-	1263		
Porta SILENCE Rw=37dB rebated with a steel door frame	80	844	2030	49 / 50	876	2055	796	2013	856	2043	906	-	2068	±10 / ±5
	90	968			1000		920		980		1030	-		
	100	1044			1076		996		1056		1106	-		
Porta SILENCE Rw=37dB non-rebated with a steel door frame	80	818	2017	49 / 50	875	2055	795	2013	855	2043	905	-	2068	+10 / +5
	90	968			1026		945		1005		1055	-		
	100	1018			1075		995		1055		-	-		
Rw=42 dB with reinforced Porta SYSTEM door frame	80	868	2047	68 / 69	915	2080	802	2020	872	2056	968	1008	architrave (6) / (8) 2104 / 2124	+20 / +10
	90	968			1015		902		972		1068	1108		
	100	1068			1115		1002		1072		1168	1208		
Rw=42 dB with MDF door frame	80	868	2047	68 / 69	975	2105	802	2021	946	2093	1048	1088	architrave (6) / (8) 2144 / 2164	±10 / ±5
	90	968			1075		902		1046		1148	1188		
	100	1068			1175		1002		1146		1248	1288		
Rw=42 dB with steel door frame*	80	888	2047	68 / 69	890	2055	810	2015	870	2045	950	-	2085	±10 / ±5
	90	988			990		910		970		1050	-		
	100	1088			1090		1010		1070		1150	-		
EI 30 with MDF door frame	60	644	2030	44 / 45	750	2090	602	2014	722	2077	824	864	architrave (6) / (8) 2128 / 2148	±10 / ±5
	70	744			850		702		822		924	964		
	80	844			950		802		922		1024	1064		
	90	952			1060		910		1030		1132	1172		
	100	1044			1150		1002		1122		1224	1264		
EI 30, Rw=27 dB, Rw=32 dB with a steel door frame*	60	644	2030	44 / 45 40 / 41 44 / 45	675	2055	596	2013	656	2043	706	-	2068	±10 / ±5
	70	744			775		696		756		806	-		
	80	844			875		796		856		906	-		
	90	952			985		904		964		1014	-		
	100	1044			1075		996		1056		1106	-		
Rw=27 dB, Rw=32 dB with a steel door frame for plaster- board walls	60	644	2030	40 / 41 44 / 45	685	2058	596	2013	680	2058	706	-	2068	+10 / +5
	70	744			785		696		780		806	-		
	80	844			885		796		880		906	-		
	90	952			993		904		988		1014	-		
	100	1044			1085		996		1080		1106	-		
ENDURO	60	644	2030	40	675	2055	596	2016	656	2046	706	-	2071	±10 / ±5
	70	744			775		696		756		806	-		
	80	844			875		796		856		906	-		
	90	952			985		904		964		1014	-		
	100	1044			1075		996		1056		1106	-		
ENDURO with a swinging door frame	60	618	2017	40	750	2085	638	2030	728	2075	728	-	2075	±10 / ±5
	70	718			850		738		828		-			
	80	818			950		838		928		-			
	90	918			1050		938		1028		-			
AQUA	60	618	2017	40	675	2055	596	2016	656	2046	706	-	2071	±10 / ±5
	70	718			775		696		756		806	-		
	80	818			875		796		856		906	-		
	90	926			983		904		964		1014	-		
	100	1018			1075		996		1056		1106	-		
Strength performance Class 4 with corner profiledoor frame LARGE for concrete walls	70	752	2030	40	783	2055	704	2016	764	2046	814	-	2071	±10 / ±5
	80	852			883		804		864		914	-		
	90	952			983		904		964		1014	-		
	100	1052			1083		1004		1064		1114	-		
Strength performance Class 4 with corner profiledoor frame LARGE for plasterboard walls	70	752	2030	40	793	2055	704	2016	788	2046	814	-	2071	±10 / ±5
	80	852			893		804		888		914	-		
	90	952			993		904		988		1014	-		
	100	1052			1093		1004		1088		1114	-		
Strength performance Class 4 with ADJUSTABLE steel door frame	70	752	2030	40	798	2063	704	2016	778	2053	824	-	2076	±10 / ±5
	80	852			898		804		878		924	-		
	90	952			998		904		978		1024	-		
	100	1052			1098		1004		1078		1124	-		
Strength performance Class 4 with steel PORTA SYSTEM	70	752	2030	40	784	2056	704	2016	754	2041	844	-	2086	±10 / ±5
	80	852			884		804		854		944	-		
	90	952			984		904		954		1044	-		
	100	1052			1084		1004		1054		1144	-		
Multipurpose doors for utility rooms	70	715	2017	40***	760	2050	700	2018	739	2038	796	-	2066	±10 / ±5
	80	815			860		800		839		896	-		
	90	915			960		900		939		996	-		
Steel BASIC and Steel BASIC PLUS with a corner profile door frame - SMALL PLUS	80	852	2030	40	857	2043 - Basic 2047 - Basic PLUS	804	2016	837	2033	914	-	2071 - Basic 2075 - Basic PLUS	±10 / ±5
	90	952			957		904		937		1014	-		
	100	1052			1057		1004		1037		1114	-		

\* Project (BIS and Premium) requires enlarging the wall opening S<sub>0</sub> by 30 mm and H<sub>0</sub> by 15 mm (dimension tolerance +10 mm/ +5 mm)  
Other Project door frame sizes, see drawing on page 190.

\*\* Steel threshold decreases given dimension by 16 mm.

\*\*\* Door leaf thickness is measured on vertical edges (door leaf without infill, opened from closing side).



# Door dimensions tables

POLISH NORM (PN)

## TECHNICAL DOORS

TABLE 4

DOOR FRAME TYPE	SIZE	S <sub>s</sub>	H <sub>s</sub>	D <sub>s</sub>	S <sub>o</sub>	H <sub>o</sub>	O <sub>s</sub>	O <sub>w</sub>	S <sub>b</sub>	H <sub>b</sub>	S <sub>z</sub> (6)	S <sub>z</sub> (8)	H <sub>z</sub> (8)	T <sub>sw</sub>
EI 60 with a wooden door frame	60	668	2030	60 / 61	775	2090	628	2017	747	2077	858	-	2133	±10 / ±5
	70	768			875		728		847		958	-		
	80	868			975		828		947		1058	-		
	90	968			1075		928		1047		1158	-		
EI 60 with a steel door frame*	60	668	2030	60 / 61	700	2055	618	2011	678	2041	732	-	2068	±10 / ±5
	70	768			800		718		778		832	-		
	80	868			900		818		878		932	-		
	90	968			1000		918		978		1032	-		
EI30 PLUS, EI60 PLUS	60	720	2040	62	745	2065	660	2023	730	2057	780	-	2083	±10 / ±5
	70	820			845		760		830		880	-		
	80	920			945		860		930		980	-		
	90	1020			1045		960		1030		1080	-		
	100	1120			1145		1060		1130		1180	-		
EI30 PLUS, EI60 PLUS double	90+30**	1423	2040	62	1445	2065	1363	2023	1431	2057	1483	-	2083	±10/±5
	90+40**	1523			1545		1463		1531		1583	-		
	90+50**	1623			1645		1563		1631		1683	-		
	90+60	1723			1745		1663		1731		1783	-		
	90+70	1823			1845		1763		1831		1883	-		
	90+80	1923			1945		1863		1931		1983	-		
	90+90	2023			2045		1963		2031		2083	-		
INNOVO 37 dB with Porta SYSTEM door frame	60	644	2030	44	680	2060	602	2016	650	2040	746	786	architrave (6) / (8) 2088 / 2108	+20 / +10
	70	744			780		702		750		846	886		
	80	844			880		802		850		946	986		
	90	968			1005		926		974		1070	1110		
	100	1044			1080		1002		1050		1146	1186		
INNOVO 37 dB with steel door frame	60	644	2030	44	675	2055	595	2013	656	2043	705	-	2068	+10 / +5
	70	744			775		696		756		806	-		
	80	844			875		796		856		906	-		
	90	968			1000		920		980		1030	-		
	100	1044			1075		996		1056		1106	-		
INNOVO 42 dB with MDF door frame	80	888	2047	62	990	2105	822	2021	966	2093	1068	1008	architrave (6) / (8) 2144 / 2164	±10 / ±5
	90	988			1090		922		1066		1168	1108		
	100	1088			1190		1022		1166		1268	1208		
INNOVO 42 dB with Porta SYSTEM door frame	80	888	2047	62	925	2075	822	2020	894	2056	990	1030	architrave (6) / (8) 2104 / 2124	+20 / +10
	90	988			1025		922		994		1090	1130		
	100	1088			1125		1022		1094		1190	1230		
INNOVO 42 dB with steel dppr frame	80	888	2047	62	890	2055	810	2015	870	2045	950	-	2085	±10/±5
	90	988			990		910		970		1050	-		
	100	1088			1090		1010		1070		1150	-		
PURE with Porta SYSTEM door frame	80	868	2047	68	915	2080	802	2020	872	2056	968	1008	architrave (6) / (8) 2104 / 2124	+20 / +10
	90	968			1015		902		972		1068	1108		
	100	1068			1115		1002		1072		1168	1208		
PURE with MDF door frame	80	868	2047	68	975	2105	802	2021	946	2093	1048	1088	architrave (6) / (8) 2144 / 2164	±10/±5
	90	968			1075		902		1046		1148	1188		
	100	1068			1175		1002		1146		1248	1288		

\*\* passive leaf - flush door (without glass)

## APARTMENT ENTRANCE DOORS

TABLE 5

DOOR FRAME TYPE	SIZE	S <sub>s</sub>	H <sub>s</sub>	D <sub>s</sub>	S <sub>o</sub>	H <sub>o</sub>	O <sub>s</sub>	O <sub>w</sub>	S <sub>b</sub>	H <sub>b</sub>	S <sub>z</sub> (6)	S <sub>z</sub> (8)	H <sub>z</sub>	T <sub>sw</sub>
AGATE, OPAL, QUARTZ, GRANITE kl. C with a steel door frame**	80	844	2030*	40 / 41 44 / 45 48 / 49	876	2056	796	2016***	856	2046	906	-	2071	±10 / ±5
	90	952			986		904		964		1014	-		
	100	1044			1076		996		1056		1106	-		
EXTREME RC2, EXTREME RC 3 with a steel door frame**	80	844	2032	50	876	2056	796	2016	856	2046	906	-	2071	+10 / +5
	90	968			1000		920		980		1030	-		
	100	1044			1076		996		1056		1106	-		
EXTREME RC 3 with PS frame	80	844	2032	50	880	2060	802	2018	850	2042	-	986	2110	+20 / +10
	90	968			1005		926		974		-	1110		
	100	1044			1080		1002		1050		-	1186		
EXTREME RC 4 with a steel door frame**	80	844	2032	54	880	2060	798	2016***	858	2046	908	-	2071	±10/±5
	90	968			1005		922		982		1032	-		
	100	1044			1080		998		1058		1108	-		
Steel SECURE	80	868	2040	54	900	2065	820	2025	880	2055	930	-	2080	±10/±5
	90	968			1000		920		980		1030	-		
	100	1068			1100		1020		1080		1130	-		
Steel SAFE	80	868	2037	54	900	2065	820	2023***	880	2053	930	-	2078	±10/±5
	90	968			1000		920		980		1030	-		
	100	1068			1100		1020		1080		1130	-		

\* For Granite class C Hs=2032

\*\* Project (BIS and Premium) requires enlarging the wall opening So by 30 mm and Ho by 15 mm (dimension tolerance +10 mm/ +5 mm)

Other Project door frame sizes, see drawing on page 190.

\*\*\* Steel threshold decreases given dimension by 16 mm.

## EXTERNAL DOORS

TABLE 6

DOOR FRAME TYPE	SIZE	S <sub>s</sub>	H <sub>s</sub>	D <sub>s</sub>	S <sub>o</sub>	H <sub>o</sub>	O <sub>s</sub>	O <sub>w</sub>	S <sub>b</sub>	H <sub>b</sub>	S <sub>z</sub>	H <sub>z</sub>	T <sub>sw</sub>
Steel SAFE	80	868	2037	54	900	2065	820	2023*	880	2053	930	2078	±10/±5
	90	968			1000		920		980		1030		
	100	1068			1100		1020		1080		1130		
Steel SAFE with Thermo door frame	80	868	2037	54	900	2065	822	2023*	882	2053	932	2078	±10/±5
	90	968			1000		922		982		1032		
	100	1068			1100		1022		1082		1132		
Steel ENERGY PROTECT	80	868	2037	66	900	2065	822	2023*	882	2053	932	2078	±10/±5
	90	968			1000		922		982		1032		
	100	1068			1100		1022		1082		1132		

\* Steel threshold decreases given dimension by 16 mm.

# Door dimensions tables

POLISH NORM (PN)

## SLIDING SYSTEMS, FOLDING DOORS

TABLE 7

	SIZE	S <sub>s</sub>	H <sub>s</sub>	D <sub>s</sub>	S <sub>o</sub>	H <sub>o</sub>	O <sub>s</sub>	O <sub>w</sub>	H <sub>z</sub>	M <sub>s</sub> (6)/(8)	M <sub>G</sub>	B <sub>G</sub>	T <sub>sw</sub>
Porta sliding system	60	644	2030	40	680	2060	602	2016	2119	1413	103	60	+20 / +10
	70	744			780		702			1613			
	80	844			880		802			1813			
	90	944			980		902			2013			
	100	1044			1080		1002			2213			

	SIZE	S <sub>s</sub>	H <sub>s</sub>	D <sub>s</sub>	S <sub>o</sub> (6)/(8)	H <sub>o</sub>	O <sub>s</sub> (6)	O <sub>s</sub> (8)	O <sub>w</sub>	H <sub>z</sub>	M <sub>s</sub> (6)/(8)	M <sub>G</sub>	T <sub>sw</sub>	
ALU sliding system	60	744	2030	40	680/640	2060	602	560	2016	2114	68	68	+20 / +10	
	70	844			780/740		702	660						1448
	80	944			880/840		802	760						1648
	90	1044			980/940		902	860						1848
	110	2 x 644			1220/1180		1145	1104						2048
	130	2 x 744			1420/1380		1345	1304						2452
	150	2 x 844			1620/1580		1545	1504						2852
	170	2 x 944			1820/1780		1745	1704						3252

	SIZE	S <sub>s</sub>	H <sub>s</sub>	D <sub>s</sub>	S <sub>o</sub> (6)/(8)	H <sub>o</sub>	O <sub>s</sub>	O <sub>w</sub>	S <sub>b</sub>	H <sub>b</sub>	S <sub>z</sub> (6)	S <sub>z</sub> (8)	H <sub>z</sub> (6)/(8)	T <sub>sw</sub>
ALFA system	60	644	2000	40	680	2060	460	2016	646	2043	746	786	2088/2108	+20 / +10
	70	744			560		746		846		886			
	80	844			660		846		946		986			
	90	944			760		946		1046		1086			
	100	1044			860		1046		1146		1186			
ALFA system	60	588	1990	40	680	2070	450	2016	646	2050	746	786	2088/2108	+20 / +10
	70	688			550		746		846		886			
	80	788			650		846		946		986			
	90	888			750		946		1046		1086			

	SIZE	S <sub>s</sub>	H <sub>s</sub>	D <sub>s</sub>	S <sub>o</sub> *	H <sub>o</sub> *	O <sub>s</sub>	O <sub>w</sub>	S <sub>b</sub>	H <sub>b</sub>	S <sub>z</sub> (6)	S <sub>z</sub> (8)	H <sub>z</sub> (6)/(8)	S <sub>c</sub>	H <sub>c</sub>	T <sub>sw</sub>
COMPACT pocket door system - single	60	644	2030	40	660	2065	600	2018	654	2040	744	784	2090 / 2110	1355	2130	+5 / +10
	70	744			760		700		754		844	884		1555		
	80	844			860		800		854		944	984		1755		
	90	944			960		900		954		1044	1084		1955		
	100	1044			1060		1000		1054		1144	1184		2155		
COMPACT pocket door system - double	2 x 60	644	2030	40	1265	2065	1214	2018	1258	2040	1358	1398	2090 / 2110	2610	2130	+5 / +10
	2 x 70	744			1465		1414		1458		1558	1598		3010		
	2 x 80	844			1665		1614		1658		1758	1798		3410		
	2 x 90	944			1865		1814		1858		1958	1998		3810		
	2 x 100	1044			2065		2014		2058		2158	2198		4210		

\* For COMPACT pocket door system, H<sub>o</sub> and S<sub>o</sub> sizes refer to opening dimension of steel cassette to be installed with wood-based door frame.

	SIZE	S <sub>s</sub>	H <sub>s</sub>	D <sub>s</sub>	S <sub>o</sub>	H <sub>o</sub>	M <sub>s</sub>	T <sub>sw</sub>
BLACK sliding system*	70	744	2090	40	680	2060	2000	±10 / ±5
	80	844			780			
	90	944			880			
	100	1044			980			
SLIDE sliding system	70	744	2200	40	680	2060	2010	±10 / ±5
	80	844			780			
	90	944			880			
	100	1044			980			
EFEKT sliding system	90	944	2230	40	680	2060	1665	-10 / ±50
	100	1044			780		1865	
	110	1144			880		2065	

\* In case of installing different door leaf than Porta BLACK, wall opening should be decreased by 60 mm

	SIZE	S <sub>s</sub>	H <sub>s</sub>	D <sub>s</sub>	S <sub>o</sub>	H <sub>o</sub>	O <sub>s</sub>	O <sub>w</sub>	S <sub>b</sub>	H <sub>b</sub>	S <sub>z</sub>	H <sub>z</sub>	S <sub>c</sub>	H <sub>c</sub>	T <sub>sw</sub>
Frameless system	70	744	2030	40	1580	2110	726	2036	823	2067	1560	2101	1580	2110	+10 / +10
	80	844			826		923		1760		1780				
	90	944			926		1023		1960		1980				

## PORTA HIDE DOORS

TABLE 8

DOOR FRAME TYPE	SIZE	S <sub>s</sub>	H <sub>s</sub>	S <sub>o</sub>	H <sub>o</sub>	O <sub>s</sub>	O <sub>w</sub>	S <sub>b</sub>	H <sub>b</sub>
Porta HIDE non-rebated (opening outward)	70	718	2017	800	2070	703	2017	787	2059
	80	818		900		803		887	
	90	918		1000		903		987	
Porta HIDE with reversed rebate (inward opening)	70	718	2027	800	2080	703	2027	787	2069
	80	818		900		803		887	
	90	918		1000		903		987	



# Door dimensions tables - height '220'

POLISH NORM (PN)

## INTERNAL DOORS WITH WOODEN DOOR FRAMES

TABLE 9

DOOR FRAME TYPE	SIZE	S <sub>s</sub>	H <sub>s</sub>	D <sub>s</sub>	S <sub>o</sub>	H <sub>o</sub>	O <sub>s</sub>	O <sub>w</sub>	S <sub>b</sub>	H <sub>b</sub>	S <sub>z</sub> (6)	S <sub>z</sub> (8)	H <sub>z</sub>	T <sub>sw</sub>
Porta SYSTEM	60	644	2230	40	680	2260	602	2216	646	2238	746	786	architrave (6) / (8) 2288 / 2308	+20 / +10
	70	744			780		702		746		846	886		
	80	844			880		802		846		946	986		
	90	944			980		902		946		1046	1086		
	100	1044			1080		1002		1046		1146	1186		
	110	1144			1180		1102		1146		1246	1286		
Porta SYSTEM ELEGANCE	60	618	2217	40	690	2260	602	2216	646	2238	-	786	2308	+10 / +10
	70	718			790		702		746		-	886		
	80	818			890		802		846		-	986		
	90	918			990		902		946		-	1086		
	100	1018			1090		1002		1046		-	1186		
	110	1118			1190		1102		1146		-	1286		
Porta SYSTEM ELEGANCE 90 degrees	60	618	2217	40	690	2260	602	2216	646	2238	-	786	2308	+10 / +10
	70	718			790		702		746		-	886		
	80	818			890		802		846		-	986		
	90	918			990		902		946		-	1086		
	100	1018			1090		1002		1046		-	1186		
	110	1118			1190		1102		1146		-	1286		
Porta SYSTEM with reversed rebate	60	639	2227	40	720	2280	626	2228	691	2261	-	831	2330	±10/±5
	70	739			820		726		791		-	931		
	80	839			920		826		891		-	1031		
	90	939			1020		926		991		-	1131		
	100	1039			1120		1026		1091		-	1231		
	110	1139			1220		1126		1191		-	1331		

NOTE: SZ and HZ dimensions of door frame in natural veneers are given with tolerance -1 mm/ + 3 mm.

\*Dimension Sz and Hz measured on the wider side of the door leaf. They are the same as dimensions of doors with PSE

## INTERNAL DOORS WITH STEEL DOOR FRAMES

TABLE 10

DOOR FRAME TYPE	SIZE	S <sub>s</sub>	H <sub>s</sub>	D <sub>s</sub>	S <sub>o</sub>	H <sub>o</sub>	O <sub>s</sub>	O <sub>w</sub>	S <sub>b</sub>	H <sub>b</sub>	S <sub>z</sub>	H <sub>z</sub>	T <sub>sw</sub>
steel Porta SYSTEM	60	644	2230	40	675	2255	596	2216	646	2241	736	2286	±10/±5
	70	744			775		696		746		836		
	80	844			875		796		846		936		
	90	944			975		896		946		1036		
	100	1044			1075		996		1046		1136		
steel Porta SYSTEM ELEGANCE*	60	618	2217	40	675	2255	596	2216	646	2241	736	2286	±10/±5
	70	718			775		696		746		836		
	80	818			875		796		846		936		
	90	918			975		896		946		1036		
	100	1018			1075		996		1046		1136		

\*If the back of the hinge does not fit in a wall opening, a little wall chasing has to be made.

### HEIGHT ,220' IS AVAILABLE IN CHOSEN COLLECTIONS:

- 4 Elements
- Porta VECTOR
- Porta ART DECO
- Porta DESIRE
- Nature CLASSIC
- Nature LINE
- Nature VECTOR

### NOTES:

- Dimensions tolerance according to PN: to 1 m +=1mm, above 1 m +-2mm.
- Side door panels for rebated door sets are available in natural veneer in size '40'; S<sub>s</sub>=444, H<sub>s</sub>=2030.
- Door frames are designed to be installed on finished floor level. For steel door frames there is a possibility to order them in lengthen option + 30 mm (to be mounted under floor level). In this case sizes H<sub>b</sub> and H<sub>z</sub> are enlarged by 30 mm (level -30).
- Given dimension refers to internal door leaves, both rebated and sliding
- Porta SYSTEM integrated with an upper transom. Dimensions H<sub>o</sub>, H<sub>g</sub>, H<sub>z</sub> +302 mm.
- Project (BIS and Premium) requires enlarging the wall opening S<sub>0</sub> by 30 mm and H<sub>0</sub> by 15 mm (dimension tolerance +-10 mm/ +-5 mm)

# Door dimensions tables

CZECH NORM/GERMAN NORM (CN/DIN)

## INTERNAL DOORS

TABLE 11

CN/DIN	SIZE	SS	HS	DS	SO	H0	OS	OW	SB	HB	SZ (6)	SZ (8)	HZ (6) / (8)	TS W
Minimax 60 mm Minimax 100 mm MDF in natural veneer	60	648/610	1985	40	715/680	2030	606/569	1971	694/657	2015	804/767	-	2070	+20 / +10
	70	748/735			815/805		706/694		794/782		904/892	-		
	80	848/860			915/930		806/819		894/907		1004/1017	-		
	90	948/985			1015/1055		906/944		994/1032		1104/1142	-		
	100	1048/-			1115/-		1006/-		1094/-		1204/-	-		
Porta SYSTEM door frame	60	648/610	1985	40	685/650	2015	606/567	1971	650/611	1993	750/711	790/751	profile (6) / (8) 2043/2063	+20 / +10
	70	748/735			785/775		706/692		750/736		850/836	890/876		
	80	848/860			885/900		806/817		850/861		950/961	990/1001		
	90	948/985			985/1025		906/942		950/986		1050/1086	1090/1126		
	100	1048/-			1085/-		1006/-		1050/-		1150/-	1190/-		
Porta SYSTEM ELEGANCE / LEVEL door frames	60	622/584	1972	40	695/660	2015/ LEVEL 2025	606/567	1971	650/611	1993/ LEVEL 2001	-	790/751	-2063/ LEVEL 2183/2983 Upper panel (20)/(100)	+20 / +10
	70	722/709			795/785		706/692		750/736		-	890/876		
	80	822/834			895/910		806/817		850/861		-	990/1001		
	90	922/959			995/1035		906/942		950/986		-	1090/1126		
	100*	1022/-			1095/-		1006/-		1050/-		-	1190/-		
Porta SYSTEM ELEGANCE 90° door frames	60	622/584	1972	40	695/660	2015	606/567	1971	650/611	1993	-	790/751	-2065	+20/+10
	70	722/709			795/785		706/692		750/736		-	890/876		
	80	822/834			895/910		806/817		850/861		-	990/1001		
	90	922/959			995/1035		906/942		950/986		-	1090/1126		
	100	1022/-			1095/-		1006/-		1050/-		-	1190/-		
se zárubní Porta SYSTEM with a reversed rebate*	60	643/-	1982	40	725/-	2035	630/-	1983	695/-	2015	-	835/-	-2085	±10/±5
	70	743/-			825/-		730/-		795/-		-	935/-		
	80	843/-			925/-		830/-		895/-		-	1035/-		
	90	943/-			1025/-		930/-		995/-		-	1135/-		
	100	1043/-			1125/-		1030/-		1095/-		-	1235/-		
RENOVA** door frame	60	648/-	1985	40	600/561	1971	562/-	1949	588/-	1962	750/-	-	2043	+15* -6
	70	748/-			700/686		662/-		688/-		850/-	-		
	80	848/-			800/811		762/-		788/-		950/-	-		
	90	948/-			900/936		862/-		888/-		1050/-	-		
	100	1048/-			1000/-		962/-		988/-		1150/-	-		
Corner profile door frame - SMALL PLUS	60	648/610	1985	40	655/615	1995	600/561	1968	633/594	1985	710/671	-	2023	±10 / ±5
	70	748/735			755/740		700/686		733/719		810/796	-		
	80	848/860			855/865		800/811		833/844		910/921	-		
	90	948/985			955/990		900/936		933/969		1010/1046	-		
	100	1048/-			1055/-		1000/-		1033/-		1110/-	-		
Corner profile door frame -LARGE for concrete walls and stainless steel LARGE folding	60	648/610	1985	40	680/640	2010	600/561	1968	660/621	1998	710/671	-	2023	±10 / ±5
	70	748/735			780/765		700/686		760/746		810/796	-		
	80	848/860			880/890		800/811		860/871		910/921	-		
	90	948/985			980/1015		900/936		960/996		1010/1046	-		
	100	1048/-			1080/-		1000/-		1060/-		1110/-	-		
Corner profile door frame - LARGE for plasterboard walls	60	648/610	1985	40	685/645	2010	600/561	1968	684/645	1998	710/671	-	2023	+10 / +5
	70	748/735			785/770		700/686		784/770		810/796	-		
	80	848/860			885/895		800/811		884/895		910/921	-		
	90	948/985			985/1020		900/936		984/1020		1010/1046	-		
	100	1048/-			1085/-		1000/-		1084/-		1110/-	-		
ADJUSTABLE door frame	60	648/610	1985	40	695/655	2015	600/561	1968	674/635	2005	720/681	-	2028	-10 / -5
	70	748/735			795/780		700/686		774/760		820/806	-		
	80	848/860			895/905		800/811		874/885		920/931	-		
	90	948/985			995/1030		900/936		974/1010		1020/1056	-		
	100	1048/-			1095/-		1000/-		1074/-		1120/-	-		
Adjustable steel door frame, non-rebated	60	622/584	1972	40	695/655	2017	600/561	1970/1968	675/635	1995/1993	740/701	-	2040/2038	-10 / -5
	70	722/709			795/780		700/686		775/760		840/826	-		
	80	822/834			895/905		800/811		875/885		940/951	-		
	90	922/959			995/1030		900/936		975/1010		1040/1076	-		
	100	1022/-			1095/-		1000/-		1075/-		1140/-	-		
Steel Porta SYSTEM ELEGANCE***	60	622/584	1972	40	680/640	2010	600/561	1970/1968	650/611	1995/1993	740/701	-	2040/2038	±10 / ±5
	70	722/709			780/765		700/686		750/736		840/826	-		
	80	822/834			880/890		800/811		850/861		940/951	-		
	90	922/959			980/1015		900/936		950/986		1040/1076	-		
	100	1022/-			1080/-		1000/-		1050/-		1140/-	-		
Corner profile - LARGE, non-rebated, for concrete walls***	60	622/584	1972	40	680/640	2010	600/561	1970/1968	660/620	2000	740/701	-	2040/2038	±10 / ±5
	70	722/709			780/765		700/686		760/745		840/826	-		
	80	822/834			880/890		800/811		860/870		940/951	-		
	90	922/959			980/1015		900/936		960/995		1040/1076	-		
	100	1022/-			1080/-		1000/-		1060/-		1140/-	-		
Corner profile LARGE, non-rebated for plasterboard walls	60	622/584	1972	40	685/646	2010	600/561	1970/1968	684/645	2012	740/701	-	2040/2038	+10 / +5
	70	722/709			785/771		700/686		784/770		840/826	-		
	80	822/834			885/896		800/811		884/895		940/951	-		
	90	922/959			985/1021		900/936		984/1020		1040/1076	-		
	100	1022/-			1085/-		1000/-		1084/-		1140/-	-		
Steel Adjustable PS with sharp edges*	60	648/610	1985	40	705/665	2023	600/561	1968	684/645	2010	740/701	-	2038	-10 / -5
	70	748/735			805/790		700/686		784/770		840/826	-		
	80	848/860			905/915		800/811		884/895		940/951	-		
	90	948/985			1005/1040		900/936		984/1020		1040/1076	-		
	100	1048/-			1105/-		1000/-		1084/-		1140/-	-		
Steel Porta SYSTEM	60	648/610	1985	40	680/640	2010	600/561	1970/1968	650/611	1995/1993	740/701	-	2040/2038	±10/±5
	70	748/735			780/765		700/686		750/736		840/826	-		
	80	848/860			880/890		800/811		850/861		940/951	-		
	90	948/985			980/1015		900/936		950/986		1040/1076	-		
	100	1048/1110			1080/1140		1000/1061		1050/1111		1140/1201	-		

\* only Porta SYSTEM ELEGANCE

\*\* S<sub>0</sub>/H<sub>0</sub> width/height of clear opening of old steel frame. Ts/w - tolerance +15 mm depends on a construction of the old door frame



# Door dimensions tables

## CZECH NORM/GERMAN NORM (CN/DIN)

### EXTERNAL DOORS

TABLE 12

CN	SIZE	S <sub>s</sub>	H <sub>s</sub>	D <sub>s</sub>	S <sub>o</sub>	H <sub>o</sub>	O <sub>s</sub>	O <sub>w</sub>	S <sub>b</sub>	H <sub>b</sub>	S <sub>2</sub> (6)	S <sub>2</sub> (8)	H <sub>z</sub>	T <sub>s/w</sub>
Steel SAFE	80	848	1985	53	880	2010	800	1969**	860	1999	910	-	2024	±10/±5
	90	948			980		900		960		1010	-		
	100	1048			1080		1000		1060		1110	-		

### FOLDING DOORS

TABLE 13

CN/DIN	SIZE	S <sub>s</sub>	H <sub>s</sub>	D <sub>s</sub>	S <sub>o</sub>	H <sub>o</sub>	O <sub>s</sub>	O <sub>w</sub>	S <sub>b</sub>	H <sub>b</sub>	S <sub>2</sub> (6)	S <sub>2</sub> (8)	H <sub>2</sub> (6),(8)	T <sub>s/w</sub>
ALFA	60	647/609	1955	40	685/650	2015	465/425	1971	650/611	1993	750/711	790/751	profile (6)/(8) 2043/2063	+20/+10
	70	747/734			785/775		565/550		750/736		850/836	890/876		
	80	847/859			885/900		665/675		850/861		950/961	990/1001		
	90	947/985			985/1025		765/800		950/986		1050/1086	1090/1126		
	100	1047/-			1085/-		865/-		1050/-		1150/-	1190/-		
BETA	60	592/554	1945	40	685/650	2005	455/415	1971	650/611	2004	750/711	790/751	profile (6)/(8) 2043/2063	+20/+10
	70	692/680			785/775		555/540		750/736		850/836	890/876		
	80	792/806			885/900		655/665		850/861		950/961	990/1001		
	90	892/930			985/1025		755/790		950/986		1050/1086	1090/1126		

### SLIDING SYSTEMS

TABLE 14

CN/DIN	SIZE	S <sub>s</sub>	H <sub>s</sub>	D <sub>s</sub>	S <sub>o</sub>	H <sub>o</sub>	O <sub>s</sub>	O <sub>w</sub>	H <sub>z</sub>	M <sub>2</sub> (6),(8)	M <sub>6</sub>	B <sub>6</sub>	T <sub>s/w</sub>
PORTA sliding system PORTA	60	644	1985	40	684	2015	606	1971	2074	1413	103	60	+20/+10
	70	744			784		706			1613			
	80	844			884		806			1813			
	90	944			984		906			2013			
	100	1044			1084		1006			2213			

CN	SIZE	S <sub>s</sub>	H <sub>s</sub>	D <sub>s</sub>	S <sub>o</sub>	H <sub>o</sub>	O <sub>s</sub>	O <sub>w</sub>	S <sub>b</sub>	H <sub>b</sub>	S <sub>2</sub> (6)	S <sub>2</sub> (8)	H <sub>2</sub> (6),(8)	S <sub>c</sub>	H <sub>c</sub>	T <sub>s/w</sub>
COMPACT sliding system - single	60	644	1985	40	660	2020	600	1973	654	1995	744	784	*2045/ 2065*	1355	2085	+10/+5
	70	744			760		700		754		844	884		1555		
	80	844			860		800		854		944	984		1755		
	90	944			960		900		954		1044	1084		1955		
	100	1044			1060		1000		1054		1144	1184		2155		
COMPACT sliding system -double	2x60	2x 644	1985	40	1300	2020	1249	1973	1293	1995	1393	1433	*2045/ 2065*	2845	2085	+10/+5
	2x70	2x 744			1500		1449		1493		1593	1633		3045		
	2x80	2x 844			1700		1649		1693		1793	1833		3445		
	2x90	2x 944			1900		1849		1893		1993	2033		3845		
	2x100	2x 1044			2100		2049		2093		2193	2233		4245		

\* For COMPACT pocket door system, H<sub>o</sub> and S<sub>o</sub> sizes refer to opening dimension of steel cassette to be installed with wood-based door frame.

CN	SIZE	S <sub>s</sub>	H <sub>s</sub>	D <sub>s</sub>	S <sub>o</sub>	H <sub>o</sub>	M <sub>s</sub>	T <sub>s/w</sub>
BLACK sliding system/ SLIDE sliding system	70	744	2045 Black/ 2155 Slide	40	680	2015	2000	+10/+5
	80	844			780			
	90	944			880			
	100	1044			980			

CN	SIZE	S <sub>s</sub>	H <sub>s</sub>	D <sub>s</sub>	S <sub>o</sub>	H <sub>o</sub>	O <sub>s</sub>	O <sub>w</sub>	S <sub>b</sub>	H <sub>b</sub>	S <sub>2</sub>	H <sub>z</sub>	S <sub>c</sub>	H <sub>c</sub>	T <sub>s/w</sub>
Frameless sliding system	70	744	1985	40	1580	2070	726	1991	823	2022	1560	2056	1580	2070	+20/+10
	80	844			1780		826		923		1760		1780		
	90	944			1980		926		1023		1960		19980		

### PORTA HIDE DOORS

TABLE 15

CN	SIZE	S <sub>s</sub>	H <sub>s</sub>	D <sub>s</sub>	S <sub>o</sub>	H <sub>o</sub>	O <sub>s</sub>	O <sub>w</sub>	S <sub>b</sub>	H <sub>b</sub>
Porta HIDE non-rebated (opening outward)	70	722	1972	40	804	2025	707	1972	791	2014
	80	822			904		807		891	
	90	922			1004		907		991	
Porta HIDE with reversed rebate (inward opening)	70	722	1982	40	804	2035	707	1982	791	2024
	80	822			904		807		891	
	90	922			1004		907		991	

# Door dimensions tables

## CZECH NORM/GERMAN NORM (CN/DIN)

### TECHNICAL DOORS

TABLE 16

CN	SIZE	S <sub>3</sub>	H <sub>3</sub>	D <sub>3</sub>	S <sub>0</sub>	H <sub>0</sub>	O <sub>3</sub>	O <sub>w</sub>	S <sub>B</sub>	H <sub>B</sub>	S <sub>2(6)</sub>	S <sub>2(8)</sub>	H <sub>2(6)</sub>	H <sub>2(8)</sub>	T <sub>sw</sub>
Porta SILENCE Rw=37 dB adjustable rebated	80	848	1985	49+50	885	2015	806	1971	854	1995	951	991	2044	2064	+20/+10
	90	948			985		906		954		1051	1091			
	100	1048			1085		1006		1054		1151	1191			
Porta SILENCE Rw=37 dB adjustable non-rebated	80	822	1972	49+50	885	2015	806	1971	854	1995	951	991	2044	2064	+20/+10
	90	922			985		906		954		1051	1091			
	100	1022			1085		1006		1054		1151	1191			
Porta SILENCE Rw=37 dB fixed, rebated	80	848	1985	49+50	955	2045	806	1971	926	2031	1031	1071	2080	2100	±10/±5
	90	948			1055		906		1026		1131	1171			
	100	1048			1155		1006		1126		1231	1271			
Porta SILENCE Rw=37 dB fixed, non-rebated	80	822	1972	49+50	955	2045	806	1971	926	2031	1031	1071	2080	2100	±10/±5
	90	922			1055		906		1026		1131	1171			
	100	1022			1155		1006		1126		1231	1271			
Porta SILENCE Rw=37dB rebated, with a steel door frame	80	848	1985	49+50	880	2010	800	1968	860	1998	910	-	2023	-	±10/±5
	90	948			980		900		960		1010	-			
	100	1048			1080		1000		1060		1110	-			
Porta SILENCE Rw=37dB non-rebated, with a steel door frame	80	822	1972	49+50	880	2010	800	1968	860	1998	910	-	2023	-	+10/+5
	90	922			980		900		960		1010	-			
	100	1022			1080		1000		1060		1110	-			
EI30 s (fixed) MDF	60	648	1985	44+45	755	2045	606	1971	726	2031	831	871	2080	2100	±10/±5
	70	748			855		706		826		931	971			
	80	848			955		806		926		1031	1071			
	90	948			1055		906		1026		1131	1171			
	100	1048			1155		1006		1126		1231	1271			
EI 30 wooden, with corner profile frame - LARGE	60	648	1985	44+45	680	2010	600	1968	660	1998	710	-	2023	-	±10/±5
	70	748			780		700		760		810	-			
	80	848			880		800		860		910	-			
	90	948			980		900		960		1010	-			
	100	1048			1080		1000		1060		1110	-			
AGAT, OPAL*	80	848	1985	44+45	880	2010	800	1968**	860	1998	910	-	2023	-	±10/±5
	90	948			980		900		960		1010	-			
	100	1048			1080		1000		1060		1110	-			
QUARTZ GRANITE cl. C	80	848	1985	44+45	880	2010	800	1968	860	1998	910	-	2023	-	±10/±5
	90	948			980		900		960		1010	-			
	100	1048			1080		1000		1060		1110	-			
GRANITE RC3, EXTREME - steel door frame	80	848	1985	50	880	2010	800	1968	860	1998	910	-	2023	-	+10/+5
	90	948			980		900		960		1010	-			
	100	1048			1080		1000		1060		1110	-			
GRANITE RC3, EXTREME - PS	80	848	1985	50	885	2015	806	1971	854	1995	951	991	2044	2064	+20/+10
	90	948			985		906		954		1051	1091			
	100	1048			1085		1006		1054		1151	1191			
Steel BASIC and Steel BASIC PLUS with corner profile steel door frame - SMALL PLUS	60	648	1985	40	653	1997-Basic 2001-Basic PLUS	600	1970	633	1987	710	-	2025-Basic 2029-Basic PLUS	-	±10/±5
	70	748			753		700		733		810	-			
	80	848			853		800		833		910	-			
	90	948			953		900		933		810	-			
	100	1048			1053		1000		1033		1010	-			

\* Project (BIS and Premium) requires enlarging the wall opening S<sub>0</sub> by 30 mm and H<sub>0</sub> by 15 mm (dimension tolerance ±10 mm / ±5 mm).  
Other Project door frame sizes, see drawing on page 218.

\*\* Steel threshold decreases given dimension by 16 mm.



# Durability levels of Porta finishes

## ■ CHECK THE NUMBER OF STARS NEXT TO EVERY FINISH

You can find six groups in below classification of Porta finishes. Finishes were grouped considering quality, durability and resistance to external conditions. We hope that this classification will help you to make the best possible choice. You can find the information about durability level next to each product.

<p><b>ECONOMIC</b> ★☆☆☆☆</p> <p>The most advantageous combination of cost, and quality.</p>	<p><b>STANDARD</b> ★★☆☆☆☆</p> <p>Basic durability level which provides the possibility of long-term use in household.</p>	<p><b>STANDARD PLUS</b> ★★★☆☆</p> <p>Improved STANDARD class with enhanced parameters of resistance to abrasion and humidity.</p>
<p><b>PREMIUM</b> ★★★★★</p> <p>A perfect combination of design and guaranteed high quality. Indications for use: residential buildings and offices.</p>	<p><b>PROFESSIONAL</b> ★★★★★☆</p> <p>Durability level that combines great practicality and elegance in any place where doors are directly exposed to long-term external factors. Suggested indications for use: hotels, public buildings and offices.</p>	<p><b>EXTREME</b> ★★★★★★</p> <p>High durability level which guarantees door protection from intensive usage. Indications for use - places with heavy foot traffic, where hundreds of people pass daily.</p>

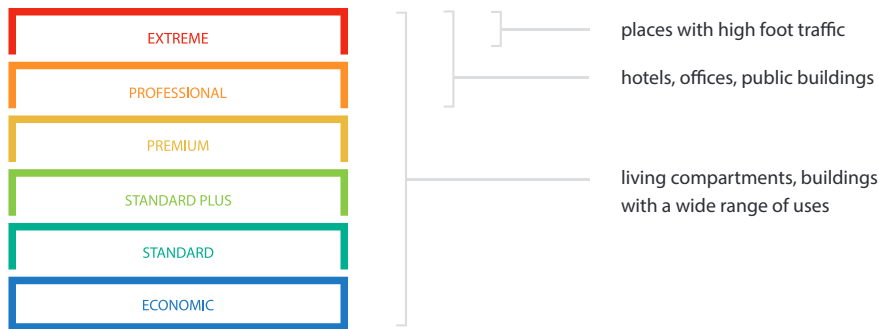

Detailed veneer data, see webpage: [www.porta.com.pl/kartyoklein](http://www.porta.com.pl/kartyoklein)



Especially for you, basing on European standards, we have developed a classification of finishes (durability levels). We took into account various external factors which directly affects the durability of the door surface. Durability levels depends on the resistance to the following factors which make an impact on doors and finishes in everyday use.

### ABRASION



Unavoidable during any door usage. Every day doors are exposed to lots of abrasions, caused by people walking through and opening doors inappropriately because of their hands occupied with documents or belongings

### DAYLIGHT



The factor which changes the colour shade in long term use. We have checked all types of veneer for you. Especially their reaction to daylight during long year use. We are proud to emphasize that the finishes we chose, achieve very good results throughout the entire time of use.

### DETERGENTS



Housekeeping, both at home and in a workplace involves the use of detergents which make an impact on surface durability.

### HUMIDITY



Direct exposure to highly humid air influences veneer. Its resistance to this factor guarantees constancy of shape and solid surface throughout the whole time of use.

# Finishes charts

## RAL colours



### Standard paint ★★☆☆☆☆

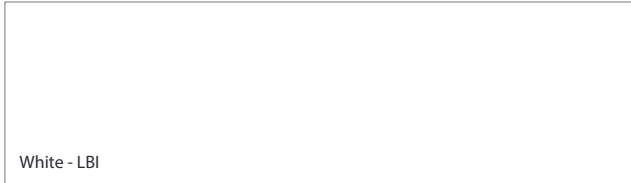

### Premium paint ★★★★★☆

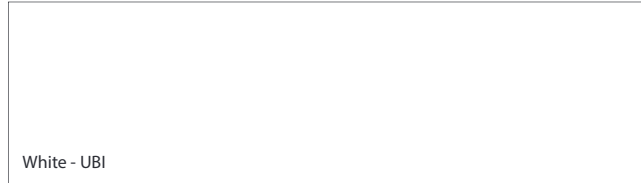

### UV acrylic paint ★★★★★☆

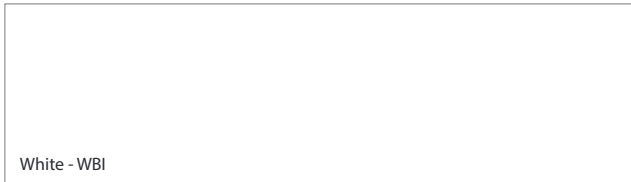

### UV acrylic paint ★★★★★☆



WHITE COLOUR IS COMPARABLE WITH RAL 9003

Due to technology and use of various materials for door frames and door leaves, there might appear slight difference between them.

GREY COLOUR IS COMPARABLE WITH RAL 7035

This finish is available only for Porta GRANDE collection and for door frames with UV acrylic paint finish

### Premium veneer ★★★★★☆

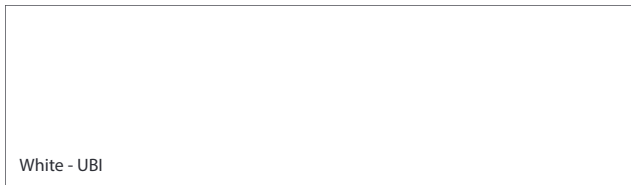

### SUPER MATT veneer ★★★★★☆



This finish is available only for Porta SYSTEM ELEGANCE

### Portasynchro 3D veneer ★★★★★☆

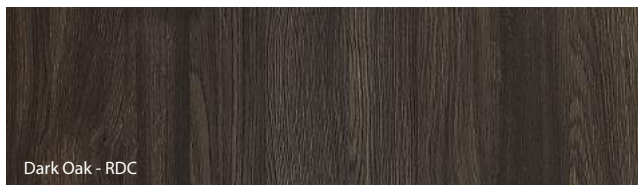

At Porta we do our best to create a perfect colour match of offered doorsets. However due to technology and materials slight differences may appear.

# Finishes charts

## Portadecor veneer ★★★★★

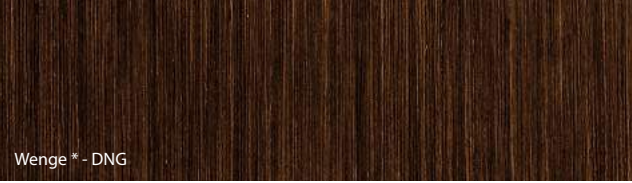

\* until stocks last  
GREY FINISH IS COMPARABLE WITH RAL 7047/ NCS S 2000-N

## Portadur veneer ★★★★★



\* until stocks last

## Portalamino veneer ★★★★★



At Porta we do our best to create a perfect colour match of offered doorsets. However due to technology and materials slight differences may appear.

# Finishes charts

## Portaperfect 3D veneer ★★★★★☆

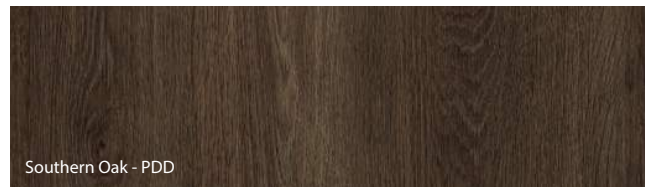
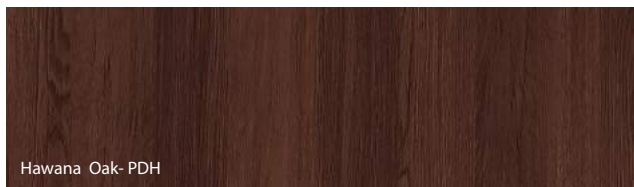
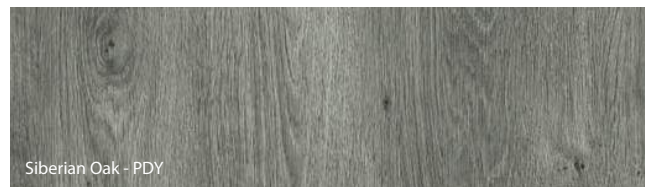
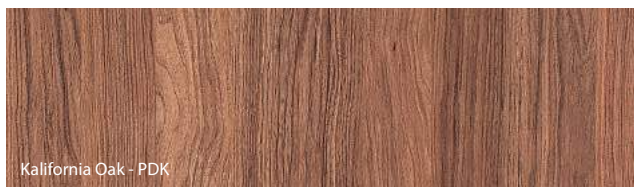
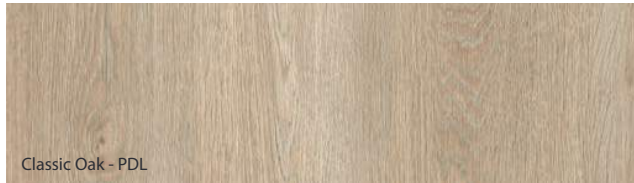

## Gladstone/Halifax board ★★★★★★

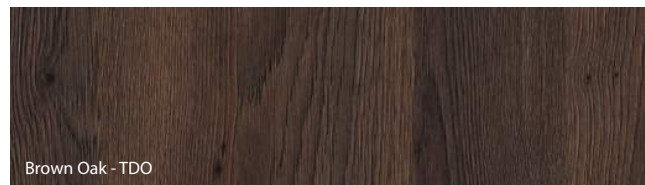
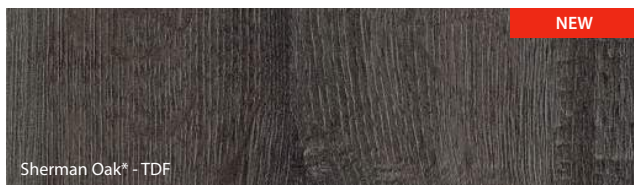
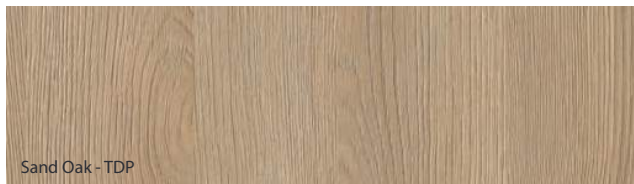

At Porta we do our best to create a perfect colour match of offered doorsets. However due to technology and materials slight differences may appear.





## Natural veneer - Oak ★★★★★☆☆



Oak 1 - ND1/KD1

Finishes key:  
N- 'striped' wood grain  
K- 'flower' wood grain

Certain veneer pattern is received thanks to proper wood selection, appropriate veneer leaf processing and its folding technique. Striped - veneer with a consistent wood graining. Flower (flader) - veneer with a natural, clear and patterned wood grain.

Due to the characteristic of natural veneers, differences in colour and graining, might appear on a door leaf. These differences cannot be grounds for complaints.

## Natural veneer - Oak Matt ★★★★★☆☆



Oak Matt\* - NSM

## Natural veneer - Walnut ★★★★★☆☆



Walnut - KO1

## Natural veneer - Ash ★★★★★☆☆



Ash - KJ1

## Natural veneer - Select ★★★★★☆☆



Oak - MDX



Dark Walnut - EQX



Black - MEC

**Natural veneer 'Select'** - is a specially prepared and selected natural veneer characterized by high repeatability of the wood grain and colour. Products finished with this type of veneer meet the high quality standards.

**Natural veneers:** Oak Ash, Walnut and Satin Oak - are characterized by a variety of colorus, graining, etc. Their properties are the result of: natural environment of trees, climate, habitat conditions. These morphological properties of wood, which are characteristic for a natural material, distinguish it from synthetic finishes and aren't defective in any way.

BLACK COLOUR IS COMPARABLE WITH RAL 9017

At PORTA we do our best to create a perfect colour match of offered doorsets. However due to technology and materials slight differences may appear.



# Finishes charts

## Natural veneer - Oak Satin ★★★★★☆☆

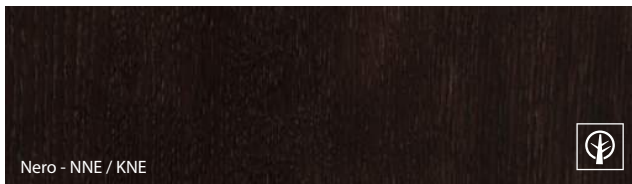
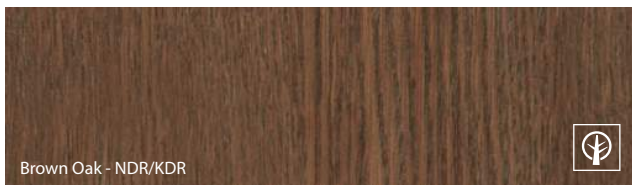
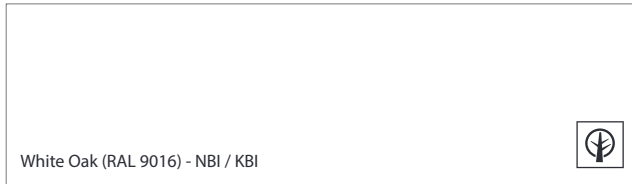

Due to the characteristic of natural veneers, differences in colour and graining, might appear on a door leaf. These differences cannot be grounds for complaints.



# Finishes charts

## Laminated steel sheet (PVC) ★★★★★☆

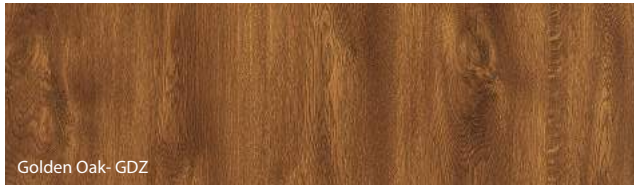

\* until stocks last

## Coated steel sheet ★★★★★☆☆

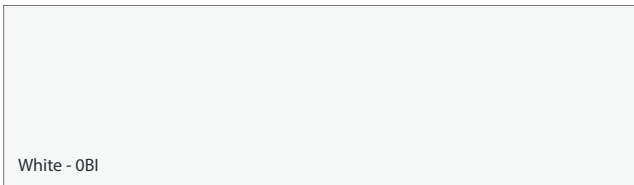

Due to type of used material, products colour are comparable to RAL colours.

White colour is comparable with RAL 9010 / Grey is comparable with RAL 7035

Anthracite is comparable with RAL 7024 / Brown is comparable with RAL 8017

## Galvanized steel sheet ★★★★★☆☆



## Stainless steel ★★★★★★



At Porta we do our best to create a perfect colour match of offered doorsets. However due to technology and materials slight differences may appear.





# Finishes charts

## Premium polyester paint ★★★★★☆

Group I	White MAT - LBM	Grey MAT - LPM
	Brown MAT - LRM	Beige MAT - LKM
	Anthracite HPL/CPL - LNC *	Structured anthracite - LNT
Group II	Structured black - LCS	
Group III	White - LBI	Grey - LPO
	Brown - LBR	Black MAT - LCM

\* HPL/CPL marking was introduced considering dedicated veneer Anthracite HPL/CPL

White colour (LBM) is comparable with RAL 9003 / White (LBI) is comparable with RAL 9016  
 Grey (LPM, LPO) is comparable with RAL 7047/ Brown (LRM, LBR) is comparable with RAL 8028  
 Beige (LKM) is comparable with RAL 1019/ Black (LCM) is comparable with RAL 9017  
 Structured anthracite (LNT) is comparable with RAL 7024

## Prime paint ★★★★★☆☆



Prime paint - Grey (LBP) is comparable with RAL 7035

At Porta we do our best to create a perfect colour match of offered doorsets. However due to technology and materials slight differences may appear.

# GLASS PANELS

---

## ■ GLASS PANEL TYPES



Frosted glass panel



'Chinchilla' glass panel



Frosted glass panel 'frame'



transparent glass panel

Glass panels dimensions are available at [www.porta.com.pl/do-pobrania](http://www.porta.com.pl/do-pobrania)

**Select  
products  
with top  
quality  
mark**



**i** Manufacturer's identification is placed above the door lock.



**5 YEAR\***  
WARRANTY ON ALL PRODUCTS

**36 MONTHS**  
FOR DOOR LEAVES AND DOOR FRAMES

**+ ADDITIONAL  
24 MONTHS**  
WHEN USING AUTHORIZED  
ASSEMBLY GROUPS

**IF YOU ARE LOOKING FOR:**

- HIGH QUALITY DOORS
- INNOVATIVE DESIGN
- PRODUCTS WITH CERTIFICATES AND TECHNICAL APPROVALS
- TESTED INVESTMENT SOLUTIONS
- EXTENSIVE DISTRIBUTION NETWORK IN POLAND AND ABROAD
- PROFESSIONAL AFTER-SALES SERVICE

**YOU WILL FIND IT IN THE PORTA DOORS PORTFOLIO**



**DETAILED REGULATIONS OF THE  
PROGRAM ARE AVAILABLE AT:**

<https://www.porta.com.pl/dm/regulamin5lat.pdf>

\* EXTERIOR, WOODEN DOORS warranty 24+12 months (with assembly)

# CUSTOMISE DOORS TO MEET YOUR INDIVIDUAL NEEDS.

## DESIGN

Customise the door design to match the style and functionality of your interior.

## FUNCTION

Customise functional properties of The doors To a room and a building.

## PARAMETERS

Customise parameters to meet the requirements of architectural design.

## COLOUR

Customise the door colour to match the surroundings.



Wide range of products is available both in standard and non-standard options.  
More inspiration and and advices in Porta catalogues: [www.portadoors.com/do-pobrania](http://www.portadoors.com/do-pobrania)

## PORTA KMI Poland Closed Joint-Stock Company

Szkolna 54, 84-239 Bolszewo, Poland  
e-mail: [info@porta.com.pl](mailto:info@porta.com.pl)

## S.C. PORTA KMI România S.R.L.

Zona Industrială Arad Nord – Vest, Strada III, Nr. 11, 310491 Arad  
[www.portadoors.ro](http://www.portadoors.ro), e-mail: [info\\_doors@porta.com.pl](mailto:info_doors@porta.com.pl)  
CUI: RO15624380, J02/910/2003, Capital social: 49.949.090 RON



- PORTA's factories
- PORTA dealers network
- PORTA dealers network